

**Recent Research Activities about the Chernobyl NPP
Accident in Belarus, Ukraine and Russia**

Edited by IMANAKA T.

**Research Reactor Institute,
Kyoto University**

July 2002

Recent Research Activities about the Chernobyl NPP Accident in Belarus, Ukraine and Russia

Preface

Sixteen years have already passed since the Chernobyl accident, the worst accident in the history of nuclear energy development occurred in the former USSR on April 26, 1986. During these years a large amount of reports, papers and materials have been published about this accident. There remain, however, many questions that were not yet answered and should be answered by future researches.

Our group, Nuclear Safety Research Group of Research Reactor Institute, Kyoto University has been involved in the task to assess the radiological consequences in case of large nuclear accidents in Japan from 1970s. So our efforts to study the consequences by the Chernobyl accident began from the next days after the accident.

During the first years after the accident, the information on Chernobyl was very limited. The detailed situation about the radioactive contamination within the USSR territory at first appeared in 1989 with growing democratic movement in USSR. The break of USSR at the end of 1991 drastically changed the situation around Chernobyl problems. In 1993 our group had a chance to collaborate with Belarusian scientists under a support from the Toyota foundation. This collaboration was extended to a larger one in 1995-1997, getting cooperation with Ukrainian and Russian scientists. Our former Chernobyl report, "Research Activities about the Radiological Consequences of the Chernobyl NPS Accident and Social Activities to Assist the Sufferers by the Accident" (KURRI-KR-21, March 1998) was produced as a result of these programs.

Under the title, "Investigation of Research Activities about the Chernobyl NPP Accident in Belarus, Ukraine and Russia", we succeeded to get a new financial support for 2000 – 2002 from Grant-in-Aid for Scientific Research of Japan Society for Promotion of Science (1.7, 2.0 and 1.9 million yen in 2000, 2001 and 2002, respectively). Compilation of a new Chernobyl report is one of the main tasks in the new program. This report contains 22 articles by Belarusian, Ukrainian and Russian scientists and one article by Imanaka.

The editor is sure that the contents of this report are useful not only to specialists, but also to all persons who have concern for the problem of Chernobyl. He is grateful to colleagues of Nuclear Safety Research Group for their continuous encouragements and to staffs of Research Reactor Institute, Kyoto University for various conveniences during the course of the present study.

Imanaka T.
Research Reactor Institute,
Kyoto University

July 2002

CONTENTS

page

1. Current Topics about the Radiological Consequences by the Chernobyl Accident	1
<i>Tetsuji IMANAKA</i>	
2. The Chernobyl Reactor: Design Features and Reasons for Accident	11
<i>Mikhail V. MALKO</i>	
3. The Causes and Scenario of the Chernobyl Accident, and Radioactive Release on the CHNPP Unit-4 Site	28
<i>Boris I. GORBACHEV</i>	
4. Nuclear Fuel in the Destroyed 4th Unit of Chernobyl NPP	45
<i>Volodymyr M. PAVLOVYCH</i>	
5. Analysis of Radioactive Contamination in the Near Zone of Chornobyl NPP	59
<i>Alexander GAYDAR and Oleg NASVIT</i>	
6. Radioecological Situation in the Cooling Pond of Chornobyl NPP	74
<i>Oleg NASVIT</i>	
7. Iodine-131 Contamination, Thyroid Doses and Thyroid Cancer in the Contaminated Areas of Russia	86
<i>Valery F. STEPANENKO, Evgeny M. PARSHKOV, Viktor A. SOKOLOV, Mark Yu. ORLOV, Alexander I. IVANNIKOV, Valery G. SKVORTSOV, Elena K. IASKOVA, Timofey V. KOLIZHENKOV, Irina G. KRYUKOVA and Anatoly F. TSYB</i>	
8. Radioactive Contamination of Food in Stepanivka Village, Zhytomyr Region, Ukraine: in 1992 and in 2001	97
<i>Volodymyr TYKHYY</i>	
9. Content of Radionuclides of Chernobyl Origin in Food Products for the Belarusian Population	103
<i>Vladimir P. MATSKO and Tetsuji IMANAKA</i>	
10. Long-Term Observation of Radioactivity Contamination in Fish around Chernobyl	112
<i>Igor N. RYABOV</i>	
11. EPR Dosimetry of Chernobyl Liquidators	123
<i>Vadim CHUMAK</i>	
12. Retrospective Dose Assessment of Inhabitants in the Contaminated Areas of Russia by EPR Measurement of Tooth Enamel	142
<i>Alexandre I. IVANNIKOV, Valeri G. SKVORTSOV and Valeri F. STEPANENKO</i>	
13. Estimations of Radiation Risk for the Population of Contaminated Territory of Belarus	152
<i>Vladimir A. KNATKO, Mikhail M. KOMOCHKOV and Alla E. YANUSH</i>	
14. Estimation of Thyroid Doses from Inhalation of ¹³¹I for Population of Contaminated Regions of Belarus	160
<i>Vladimir A. KNATKO and Inga N. DOROZHOK</i>	
15. Radiation Epidemiological Studies in Russian National Medical and Dosimetric Registry: Estimation of Cancer and Non-cancer Consequences Observed among Chernobyl Liquidators	168
<i>Marat M. MAKSIOUTOV</i>	

16. Review of Epidemiological Finding in Study of Medical Consequences of the Chernobyl Accident in Ukrainian Population	188
<i>Anatoly Ye. PRYSYAZHNYUK, Volodymir G. GRISHTSHENKO, Zoya P. FEDORENKO, Ludmila O. GULAK and Mykola. M. FUZIK</i>	
17. Intelligence and Brain Damage in Children Acutely Irradiated in Utero As a Result of the Chernobyl Accident	202
<i>Angelina I. NYAGU, Konstantin N. LOGANOVSKY, Tatiana K. LOGANOVSKAYA, Viktor S. REPIN and Stanislav Yu. NECHAEV</i>	
18. Health State of Belarusian Children Suffering from the Chernobyl Accident: Sixteen Years after the Catastrophe	231
<i>Alexander N. ARYNCHYN, Tatiana V. AVHACHEVA, Nika A. GRES and Ekaterina I. SLOBOZHANINA</i>	
19. Chernobyl Radiation-induced Thyroid Cancers in Belarus	240
<i>Mikhail V. MALKO</i>	
20. Analysis of Chromosome Aberrations in Human Lymphocytes after Accidental Exposure to Ionizing Radiation	256
<i>Galina SNIGIRYOVA and Vladimir SHEVCHENKO</i>	
21. The Follow-up Study of Chromosomal aberrations in Chernobyl Clean-up Workers	268
<i>Natalia M. SLOZINA and Elizaveta G. NERONOVA</i>	
22. Chromosomal Aberrations in Blood Lymphocytes of the Residents of 30-km Chornobyl NPP Exclusion Zone	277
<i>Larysa BEZDROBNA, Tetyana TSYGANOK, Olena ROMANOVA, Larysa TARASENKO, Volodymyr TRYSHYN and Ludmila KLIMKINA</i>	
23. Cytogenetic Effects of Radiation on Agricultural Plants Observed in the Chernobyl region during the First Years after the Accident	287
<i>Stanislav A. GERASKIN, Vladimir G. DIKAREV, Yevgenia Ya. ZYABLITSKAYA, Alla A. OUDALOVA and Yevgeniy V. SPIRIN</i>	
24. Abstracts (in Japanese)	297

Current Topics about the Radiological Consequences by the Chernobyl Accident

Tetsuji IMANAKA

*Research Reactor Institute, Kyoto University
Kumatori-cho, Sennan-gun, Osaka, 590-0494 Japan: imanaka@rri.kyoto-u.ac.jp*

Abstract

Basic radiological factors of the Chernobyl accident are reviewed such as radioactivity discharge, the size of contaminated area, radiation dose, radiation risk assessment *etc.* Roughly estimating, 50-60 % of ^{131}I and 30-50 % of ^{137}Cs in the reactor core were released into the environment, which correspond to 40-50 MCi and 2-4 MCi, respectively, as the activities at the time of the accident. The total area in 13 European countries with the ^{137}Cs contamination more than 1 Ci/km² amounts to 190,000 km². The collective thyroid dose for the entire populations in the most affected three countries (Belarus, Ukraine and Russia) is estimated 1.6×10^6 person-Gy. The collective effective dose (excluding thyroid dose) for 5.16 million people living in the main contaminated territories in three countries is estimated 4.26×10^4 person-Sv during 10 years after the accident. Using these collective doses together with radiation risk coefficients of ICRP (1990), 13,000 thyroid cancer and 2,100 other cancer deaths are expected among the corresponding populations.

Other articles in this report indicate the followings. About 4,400 cases of radiation-induced thyroid cancer were observed in Belarus by the end of 2000. There are also observed some increasing tendencies of other cancers among inhabitants in the contaminated areas and liquidators. Health deteriorations and mental retardations are observed among the children living in the contaminated areas and having received irradiation *in utero*. All these findings suggest the necessity of well organized epidemiological studies before giving conclusions about the health consequences of the Chernobyl accident as well as applicability of ICRP radiation risks to the related populations.

An interesting map is shown representing dose rate around the Chernobyl NPP on June 1, 1986. Using the dose rate in this map for reconstructing radiation dose for evacuees, the possibility of acute radiation sickness was confirmed among a substantial part of evacuees from some villages within the 30 km zone.

1. Introduction

It was more than a quarter of century ago that our group, Nuclear Safety Research Group of Kyoto University began to raise the alarm for catastrophic consequences in case of large nuclear accidents in Japan. According to our assessment based on the methodology developed by Reactor Safety Study of USNRC (1975), about 5,000 acute deaths were forecast when a severe loss-of-coolant accident would happen at the Ikata-1 NPP (560 MW, PWR) [1]. The high level of radioactive contamination was expected to extend more than 100 km along the wind stream. The Japanese authorities, however, neglected possibilities of such accidents, saying every time that nuclear power plants were designed and constructed under conceptions; "Fail Safe" and "Fool Proof".

In March 1979, a large loss-of-coolant accident happened at Three Mile Island-2 NPP (1,000 MW, PWR) in USA, which resulted in a partial meltdown of the reactor core. Fortunately, the containment of TMI-2 could keep radioactive particulates from escaping although a large amount of radioactive gases were released [2]. The radiological consequences due to the TMI-2 accident were considered rather small

in comparison with the worst ones. This accident, however, demonstrated the reality of possible catastrophic accidents at NPPs.

On April 26, 1986 an excursion accident occurred at the Chernobyl-4 (1,000 MW, RBMK) in the former USSR and destroyed the reactor and the building at a moment, which released a huge amount of radioactivity into the environment. Sixteen years have already passed since the occurrence of the Chernobyl accident. There remain, however, many questions that were not yet answered. For example, according to *Malko's article* [3], the primary causes of the Chernobyl accident were design defects of the reactor and inadequate operation manuals, while unprofessional actions of the operators of the Unit-4 were responsible for the accident, according to *Gorbachev's article* [4].

In this article, current topics about the radiological consequences of the Chernobyl accident are summarized, referring to activities of our group and the contents of the other articles in this report.

2. Radioactivity release

The amount of radioactivities released into the environment is the basic factor characterizing the scale of nuclear accidents. So far a number of estimations have been made by various authors about the radioactivity discharge by the Chernobyl accident [5-12]. Table 1 summarizes several estimations for main radionuclides.

USSR 1986 Report:

In August 1986 the Soviet government sent a delegation to the post-accident review meeting on the Chernobyl accident held in Vienna by IAEA. According to the report of the Soviet delegation [5], the total release of non-gaseous radionuclides and gaseous ones were estimated to be 50 MCi and 50 MCi, respectively. These figures were decay-corrected to the activities on May 5. The USSR 1986 Report included valuable information, but the detailed methods of their estimation were not clear. I would like to note one episode of our group with the USSR report. Our group was independently involved in the task to estimate the radioactivity release by the Chernobyl accident. In October 1986, after reading through the USSR Report extensively, Seo of our group wrote a letter to Legasov, the head of the Soviet delegation in Vienna, asking various unclearness and inconsistencies in the Soviet estimations. More than one year later, in January 1988, Seo received a kind answer from Legasov, writing "the discharge estimate has been obtained measuring fall-outs from the initial discharge, radionuclide concentration in the air in the direction of air mass motion and on the basis of model calculations" [13].

Estimation by our group:

By the end of 1986, we could collect radioactive deposition data by the Chernobyl accident from all over the northern hemisphere except for the Soviet territories. Our primary attention was directed to the ground deposition of ^{137}Cs . It was strange that our estimate for the ^{137}Cs deposition on all European countries except USSR was about 1 MCi, which was the same as the total release of ^{137}Cs estimated in the USSR 1986 Report.

Using the level of ^{137}Cs deposition as the reference nuclide of the radioactive contamination, we have analyzed dependencies of radionuclide composition on the direction and the distance from Chernobyl.

Table 1. Estimates of released radioactivity of major nuclides by the Chernobyl accident.

Nuclide	Half life	Inventory, MCi	Estimated released radioactivity, MCi (% of core inventory)				
			USSR report (1986) [5]	Seo (1988) [7]	Imanaka (1993) [9]	Ukraine (1996) [10]	Borovoi (2001) [12]
^{131}I	8.05 d	36.5	7.3 (20)	25.40 (70)	(49)	(50-60)	(50-60)
^{137}Cs	30.2 y	7.7	1.0 (13)	4.35 (57)	(31)	(20-40)	(33±10)
^{95}Zr	64 d	119	3.8 (3.2)	5.60 (4.7)	(5.0)	(3.5)	-
^{90}Sr	28 y	5.5	0.23 (4.0)	0.53 (9.6)	-	(4-6)	-

- All activities are decay-normalized to values on May 6, 1986.

- Values of reactor inventory are cited from the USSR 1986 Report.

Then, by integrating the deposition functions, the total depositions were calculated up to 3,000 km from Chernobyl [7]. The obtained results showed larger depositions than the USSR 1986 Report by factors of 4.4 and 3.5 for ^{137}Cs and ^{131}I , respectively (Table 1).

In our first estimation, only small data in the USSR 1986 Report were used for the contamination within the USSR territories. The collapse of USSR at the end of 1991 changed the situation around Chernobyl problems. In 1993 we organized a collaborative study with Belarusian scientists under a research-grant from the Toyota foundation [14]. We made new estimation using more data provided from Belarusian side [9]. Our new estimates were smaller than the previous ones and by 2.4 and 2.5 times larger than the USSR 1986 Report for ^{137}Cs and ^{131}I , respectively (Table 1).

Estimation based on the radioactivities remaining within Sarcophagus:

Another method for estimation of radionuclide discharge is to investigate the amounts of radioactivities that remain within “Sarcophagus” (the concrete building containing the destroyed 4th unit). *Pavlovych’s article* [15] describes the current situation of nuclear fuel within Sarcophagus. 190 ton of uranium was loaded in the reactor core at the time of the accident. Now within Sarcophagus, uranium fuel exists mainly in three forms: fuel fragments, LFCM (Lava-like Fuel Containing Material) and dusts. The amount of uranium in LFCM is estimated about 120 ton (min; 65, max; 165) [15]. According to Borovoi and Gagarinsky [12], it was found that 60 % of ^{137}Cs escaped from LFCM from the analysis of LFCM samples, while no amount of ^{129}I was detected in LFCM. Concerning fuel fragments dispersed from the reactor core at the time of the explosions, 25 – 37 % of ^{129}I remain within them and ^{137}Cs was retained as it was in the core. Based on these data, they concluded that 33 ± 10 % of ^{137}Cs and 50 – 60 % of ^{131}I were released from the reactor core of the Chernobyl-4.

Looking at the values in Table 1, we can roughly say that 50 - 60 % of ^{131}I , 30 - 50 % of ^{137}Cs and about 5 % of non-volatile nuclides in the reactor inventory were discharged into the environment by the Chernobyl accident. These values correspond to round estimates of radioactivities: 40 - 50 MCi of ^{131}I , 2 - 4 MCi of ^{137}Cs and 0.3 MCi of ^{90}Sr . These activities are adjusted at the time of the accident.

3. Radioactive contamination

One of unexpected features of the Chernobyl accident is that the contamination extended over a vast area on the Earth. This was caused partly by the fact that radioactive plumes reached high altitude of the atmosphere by the first explosions and the consequent fire, and partly by the fact that the radioactive discharge continued more than 10 days changing the direction of the radioactive plumes. These conditions can not be supposed in case of accidents at water power reactors such as PWR and BWR.

Cesium-137 is the most important nuclide from the point of the long-term effects of radioactive contamination. The areas of ^{137}Cs contamination more than 1 Ci/km² in European countries are summarized in Table 2 [16]. As the value of the total deposition on the northern hemisphere, 70 PBq (1.9 MCi) of ^{137}Cs is given in UNSCEAR 1988 Report [8]. This value is near the lower limit of our round estimate of ^{137}Cs release (2-4 MCi). The following two points should be noted about the estimate in UNSCEAR 1988. At first, UNSCEAR 1988 was made before the detailed information about the highly contaminated within USSR was disclosed in 1989. Based on the more recent ^{137}Cs contamination data in Table 2, the amount of total ^{137}Cs deposition in the most affected three countries (Belarus, Russia, Ukraine) is calculated to be 1.2 MCi, which is 0.5 MCi larger than the value given for the USSR territories in UNSCEAR 1988. At second, the UNCEAER 1988 estimate did not seem to include the radioactivities in the 30 km zone. The ^{137}Cs activity in the Ukrainian territory within the 30 km zone is reported to be about 0.5 MCi: 0.11 MCi on soil and 0.41 MCi in radioactive waste pits [10]. Considering these factors, the UNSCEAR 1988 estimate should be revised to 2.9 MCi, which lies in the middle of our round range. Meanwhile, according to *Nasvit’s article* [17], ^{137}Cs activity contained in the lake sediments of the cooling

Table 2 Area of ^{137}Cs contamination in European countries with more than 1 Ci/km² (km²) [16]

Country	Area (km ²)	Level of ^{137}Cs contamination, kBq/m ² (Ci/km ²)					
		10 - 20	20 - 37	37 - 185 (1 - 5)	185 - 555 (5 - 15)	555 - 1480 (15 - 40)	>1480 (>40)
Belarus	208,000	60,000	30,000	29,900	10,200	4,200	2,200
Russia	17,075,000	300,000	100,000	48,800	5,700	2,100	300
Ukraine	604,000	150,000	65,000	37,200	3,200	900	600
Sweden	450,000	37,400	42,600	12,000	-	-	-
Finland	337,000	48,800	37,400	11,500	-	-	-
Bulgaria	111,000	27,500	40,400	4,800	-	-	-
Austria	84,000	27,600	24,700	8,600	-	-	-
Norway	324,000	51,800	13,000	5,200	-	-	-
Greece	132,000	16,600	6,400	1,200	-	-	-
Slovenia	20,000	8,600	8,000	300	-	-	-
Italy	301,000	10,900	5,600	300	-	-	-
Moldova	34,000	20,000	100	60	-	-	-
Switzerland	41,000	5,900	1,900	1,300	-	-	-
Total		765,100	375,100	161,160	19,100	7,200	3,100

Note-1: ^{137}Cs level in European countries due to global fallouts by nuclear test was 2 - 3 kBq/m² in early 1990s.

Note-2: According to Chernobyl laws in Belarus, Russia and Ukraine, the contaminated territories are legally divided into the following categories depending on ^{137}Cs density:

- (1) 1-5 Ci/km² - zone of radiation control, (2) 5-15 Ci/km² - zone of guaranteed voluntary resettlement,
- (3) 15-40 Ci/km² - zone of obligatory resettlement, (4) > 40 Ci/km² - zone of alienation.

pond of the Chernobyl NPP is estimated to be 4,400 Ci.

The processes forming radioactive contamination around the territories adjacent to the Chernobyl NPP and their nuclide compositions were extensively analyzed in *Gaydar's article* [18], taking into considerations geological features of the contaminated territories. Detailed contamination maps were presented for ^{137}Cs and Pu isotopes and ^{241}Am . Interesting data are presented in *Stepanenko's article* [19] about the radioactive plume arrival and departure in contaminated settlements in Bryask, Tula and Kaluga regions of Russia. According to *Stepanenko's article* [19], about 80 % of the total ^{131}I deposition was formed during the first week after the accident.

Recent data about the food contamination of ^{137}Cs and ^{90}Sr in Belarus are reviewed in *Matsko's article* [20]. They noted that special attention should be paid to non-farm products such as mushrooms, berries and meat of wild animals. For example, about 37,000 Bq/kg of ^{137}Cs in fresh mushroom was registered in a settlement of Gomel region in 1999. *Tykhyy's article* [21] presents the results of two series of measurements that were conducted in 1992 and in 2001 at the same village in Zhytomyr region, Ukraine. The ^{137}Cs activity in milk in the village was decreased by 9 times in 2001 in comparison with 1992, while the ^{90}Sr concentration was 3 times higher in 2001 than in 1992.

Dynamics of ^{137}Cs accumulation in fish in various water bodies are described in *Ryabov's article* [22]. Although a general decreasing trend of ^{137}Cs accumulation has been observed, lowering rates are quite different, depending on fish species and conditions of water bodies. High levels of ^{137}Cs accumulation are still observed in some lakes with stagnant water. *Nasvit's article* [17] provides the results of recent radioecological monitoring of the cooling pond of the Chernobyl NPP.

3. Radiation dose and risk assessment

UNSCEAR 2000 report [11] provides a series of interesting information about radioactive contamination, dose reconstruction and health effects due to the Chernobyl accident.

Table 3. Thyroid dose for the population in the main contaminated areas.

Country	Population	Collective thyroid dose, person-Gy	Average individual thyroid dose, mGy
Belarus [11]	3,100,000	402,000	130
Russia [19]	3,100,000	106,000	34
Ukraine [11]	3,500,000	300,000	86
Total	9,700,000	808,000	83

Note; Belarus- Gomel and Brest regions. Russia - territories with ^{137}Cs contamination more than 1 Ci/km^2 in Bryansk, Orel, Tula and Kaluga regions. Ukraine - 8 districts around Chernobyl and Kiev city.

Thyroid dose and thyroid cancer risk:

Thyroid dose for the populations in the main contaminated areas in the most affected three countries is summarized in Table 3 [11, 19]. The highest average thyroid of 130 mSv is given in Belarus, while the lowest of 34 mSv is in Russia. Thyroid dose in Table 3 are given for the population including all ages. As is well known, thyroid dose to children is larger than adults. For example, among 1,988 children less than 1 year old living in the contaminated district of Gomel region, Belarus, 667 children (34 %) received thyroid dose more than 2 Gy [11]. For the evacuees from Ukrainian villages within the 30 km zone, the mean thyroid dose of 3.9 Gy is estimated for 369 children less than 1 year old, while the average thyroid dose for the people more than 18 years old is 0.40 Gy [11].

Collective thyroid dose for the entire populations of three countries are given as follows: 5.53×10^5 person-Gy for Belarus, 7.4×10^5 person-Gy for Ukraine and $(2 - 3) \times 10^5$ person-Gy for Russia. Using the total collective thyroid dose of 1.6×10^6 person-Gy for three countries and the radiation risk factor for thyroid cancer of $8 \times 10^{-2} \text{ Gy}^{-1}$ from ICRP Publication 60 [23], about 13,000 thyroid cancer cases are expected in these countries as the consequences by the Chernobyl accident. 10 % of them, that is, 1,300 cases will be fatal.

UNSCEAR 2000 Report [11] presents the data that about 1,800 thyroid cancers were observed during 1990 – 1998 in children 0 – 17 years old at the time of the Chernobyl accident: 1,067 cases in Belarus, 205 cases in Russia and 519 cases in Ukraine.

According to *Malko's article* [24], 4,400 cases of radiation-induced thyroid cancer have been already observed in the whole population of Belarus by the end of 2000: about 700 cases in children under 15 years old and 3,700 cases in adolescents and adults at the time of diagnosis. The number of additional thyroid cancer in Ukraine and Russia can be calculated using the ratio of their collective thyroid dose to Belarus. Thus, about 12,000 cases of thyroid cancer are considered to have already appeared in the affected three countries. Anyway, we have to carefully watch the results of future follow-up studies in order to give conclusions about the total outcome of thyroid cancer by the Chernobyl accident.

Knatko's article [25] describes a method to estimate thyroid dose from ^{131}I inhalation in the contaminated territories in Belarus. Average thyroid dose from inhalation for adults are estimated to be 20 and 130 mSv for the eastern and southern contaminated areas, respectively. The difference between two areas was mainly due to the differences of the $^{131}\text{I}/^{137}\text{Cs}$ ratio and the type of ^{131}I deposition (dry deposition in the southern and wet deposition in the eastern).

Effective dose and health effects other than thyroid cancer:

Estimates of effective dose for the total body (excluding thyroid dose) during the period 1986-1995 for the populations living in the contaminated areas with more than 1 Ci/km^2 are summarized in Table 4 [11]. Compared with the values for thyroid dose in Table 3, about 10 times less values are shown for effective dose. The difference among three countries is rather small. In addition, age dependency of effective dose is reported to be small compared with the case of thyroid dose [11].

Forecasts of effective dose for 70 years after the accident (1986 – 2056) are also shown in

Table 4. Effective dose for the population living in the contaminated territories more than 1 Ci/km² of ¹³⁷Cs for the period 1986-1995 (excluding thyroid dose) [11].

Country	Population	Collective effective dose (person-Sv)			Average effective dose (mSv)		
		External	Internal	Total	External	Internal	Total
Belarus	1,880,000	9,600	5,500	15,100	5.1	2.9	8.0
Russia	1,980,000	8,500	5,000	13,500	4.3	2.5	6.8
Ukraine	1,300,000	6,100	7,900	14,000	4.7	6.1	10.8
Total	5,160,000	24,200	18,400	42,600	4.7	3.5	8.2

UNSCEAR 2000 [11]. Effective dose during 10 years after the accident (1986 -1995) consists of 60 – 70 % of the 70 years dose, within which the first year (1986) contributed 23 – 28 %.

Using the collective dose of 42,600 person-Sv in Table 4 and the radiation risk coefficient for cancer mortality of $5 \times 10^{-2} \text{ Sv}^{-1}$ from ICRP [23], we can expect 2,100 cancer deaths among the 5.16 million people other than thyroid cancer. Assuming that 15 % of this population will die of spontaneous cancer, the number of cancer deaths without irradiation will amount around 770,000. Therefore, 2,100 cases of radiation-induced cancer deaths will increase the cancer death rate about 0.3 %. If the cancer risk coefficient from ICRP is applicable to the population suffering from the Chernobyl accident, it will be absolutely impossible to observe such small increase of cancer death by means of epidemiological studies.

A new cancer risk model based on recent knowledge about dose-effect relationship is proposed in *Knatko's article* [26]. According to their cancer risk assessment for 250,000 inhabitants (average effective dose, 43 mSv) living in the contaminated areas in Belarus more than 5 Ci/km² of ¹³⁷Cs, 5 – 6 % of ERR (excess relative risk) is expected during the whole life, which is about 6 times larger than the value based on the risk coefficient from ICRP. In this case 2,200 cancer deaths will be added on 37,000 spontaneous cancer deaths.

Meanwhile, a significant increase of cancer deaths among 66,000 Russian liquidators (the mean dose, about 100 mSv) is reported for the observation period 1991 – 1998 in *Maksioutov's article* [27]. The ERR coefficient is estimated to be 2.04 Sv^{-1} (95%CI: 0.45, 4.31). This value is about 60 % higher than the corresponding coefficient derived from ERR in *Kantko's article* [26]. It should be noted that a significant increase of deaths from cardiovascular diseases (0.79 Sv^{-1} , 95%CI: 0.07 – 1.64) is also observed among Russian liquidators in *Maksioutov's article* [27].

Prysyazhnyuk's article [28] presents analysis of medical statistics in Ukraine mainly based on the National Cancer Registry that was established in 1989. The results suggest increasing tendencies of female breast cancer among women liquidators, inhabitants in the most contaminated districts and evacuees from the 30 km zone. *Arynchyn's article* [29] reports the results of a prospective cohort study of children in Belarus: the main group consists of 133 children living in the contaminated territories and the control group is 186 children in clean territories. Through clinical examinations they found significantly high relative risks of the main group for diseases such as arterial hypotension and cardiac metabolic dysfunction. *Nyagu's article* [30] presents the results of medical investigation concerning brain functions of 100 children prenatally irradiated at the time of the accident and born to mothers evacuated to Kiev from the 30 km zone. Brain damages expressed as decreases of IQ indices, mental disorders *etc.* were observed among the prenatally irradiated children, compared with the control children consisting of their classmates.

Considering the findings shown in a series of epidemiological studies performed in Belarus, Ukraine and Russia, it is early to say that the radiation risk from ICRP is applicable to the populations suffering from irradiation due to the Chernobyl accident. The author would like to address the necessity of well designed and organized epidemiological studies in order to conclude about the radiation consequences by the Chernobyl accident.

Concerning the efforts to reconstruct effective dose more precisely, *Chumak's article* [31] overviews

the current situation in Ukraine about EPR dosimetry using tooth enamel. Based on the EPR measurements of 465 Ukrainian liquidators who worked in 1986-1987, the average dose of 110 mSv is obtained. This value is comparative to the average value of 130 mSv for Russian liquidators in 1986-1987 based on official records. Application of EPR dosimetry in Russia for the population living in the contaminated territories is described in *Ivannikov's article* [32]. From the regression analysis between EPR dose and ^{137}Cs contamination density, the normalized dose of 0.068 mGy per kBq/m² of ^{137}Cs was obtained during 8 years after the accident, while UNSCEAR 2000 [11] gives the value of 0.037 mSv per kBq/m² of ^{137}Cs for the rural area in Russia.

4. Cytogenetic research

Cytogenetic disturbances in cells are primary markers of irradiation effects on biological organism. *Geraskin's article* [33] presents the results of a cytogenetic experiment on plants in the first years after the accident within the 30 km zone of Chernobyl. They observed chromosome aberration in rye and wheat. Through the experiment of subsequent generations for 3 years, an increasing tendency of radiation sensitivity of chromosome aberration was observed both for rye and wheat.

Chromosome aberrations in human lymphocyte have been investigated for more than 1,500 liquidators in *Snigiryova's article* [34]. Even 15 years after the accident a significantly higher level of dicentric frequencies is still observed among liquidators although there is a general tendency of decrease for this index. In *Slozina's article* [35], an increased level of chromosome aberration in lymphocyte is also observed among the liquidators. An interesting tendency is reported that the dicentric frequency among the liquidators shows an increase for the period 8-12 years after irradiation. *Bezdrobna's article* [36] presents the results of a cytogenetic examination of 33 self-settlers in the 30 km zone of the Chernobyl NPP. The frequencies of chromosome aberration among the self-settlers were found to be significantly higher than the control group living in relatively clean territories.

5. New information about radiation situation within the 30 km zone

According to UNSCEAR 2000 [11], 49,614 people in Pripyat city and Yanov railway station were evacuated on April 27, 1986, the next day of the Chernobyl accident. Another 41,792 people evacuated from Ukrainian territory within the 30 km zone, mainly in May 3 – 7. From the Belarusian territory within the 30 km zone, 24,725 people evacuated mainly in May 2 – 7. In total, 116,231 people were evacuated from the 30 km zone. A large part of evacuees stayed at their places for 6 – 11 days before evacuation.

There are two confronting opinions about acute radiation syndromes among the inhabitants. The first one is official opinions beginning from USSR 1986 Report up to UNSCEAR 2000 Report that no case of acute radiation disease occurred among the inhabitants around the Chernobyl NPP. According to the second opinion, there should be a lot of acute radiation sicknesses among inhabitants. For example, according to the secret protocols of the Special Operative Group of the Central Committee of the USSR Communist Party [37, 38], the number of patient with radiation sickness was periodically reported to Moscow, including cases of children. Acute radiation syndromes were also confirmed from the investigation of medical records made in May – June 1986 at the Central Hospital of Khoyniki district adjacent to the Chernobyl NPP [39, 40].

The level of radiation dose to evacuees is crucial in order to judge which side of two confronting opinions is reflecting the real fact. According to UNSCEAR 2000 Report [11], the average external dose for the Ukrainian evacuees is estimated 17 mSv with the maximum individual dose of 380 mSv. Concerning Belarusian evacuees, the average external dose of 31 mSv is given for the whole evacuees, while the highest average dose of about 300 mSv is estimated for the population in two villages; Chamkov and Masany. These pieces of information are supporting the official opinion that no cases of acute radiation sickness occurred among the inhabitants.

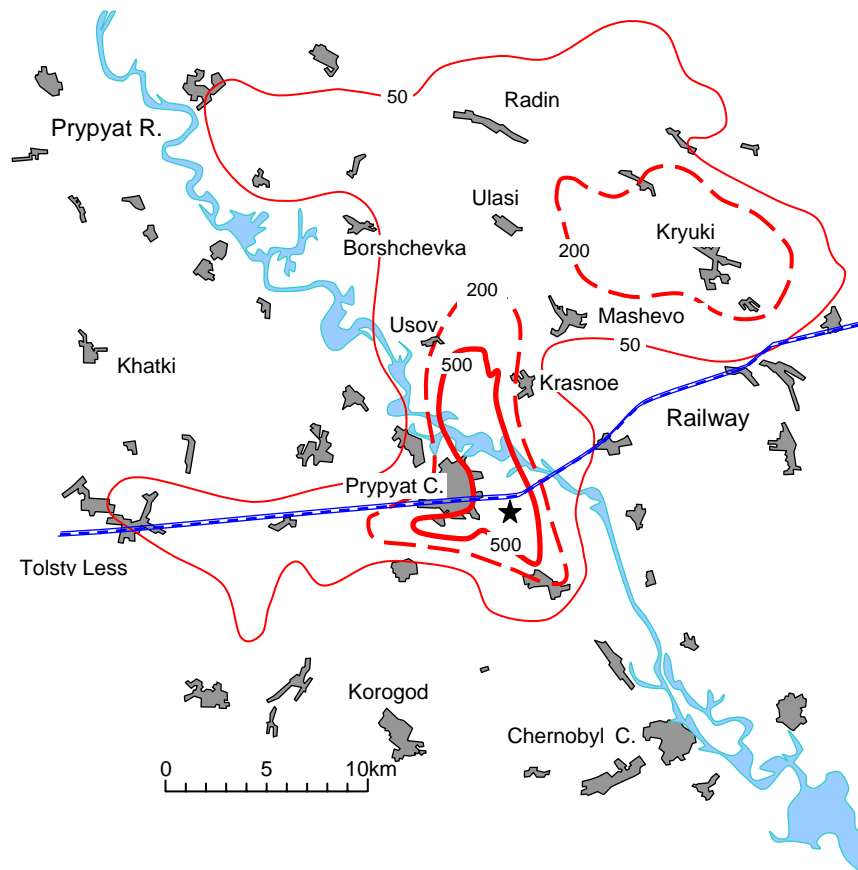

Fig. 1. Dose rate around the Chernobyl NPP on June 1, 1986; mR/h [44].

On the other hand, Imanaka [41, 42] suggested a possibility that a substantial fraction of evacuees from the most contaminated villages could receive effective dose more than 1 Sv, which is a criteria for acute radiation sickness, using the dose rate map on May 1, 1986 presented at CIS/EC Minsk conference in 1996 [43] and temporal changes of dose rate until the evacuation.

After these works Imanaka happened to find another map representing the radiation situation around Chernobyl on June 1, 1986 compiled by USSR scientists in 1991 (Fig. 1) [44]. As seen in Fig. 1, the dose rate in Usov village on June 1 was around 200 mR/h. Our previous calculations [41, 42] indicate that the dose rate on May 1 was about 10 times higher than June 1, which means that a dose rate about 2 R/h can be supposed in Usov village on May 1, 1986, from where inhabitants were evacuated on May 3.

In our previous works the average external dose of 0.32 Sv was estimated for the evacuees from Usov village based on a dose rate of 350 mR/h on May 1 in the previous map [43]. If a dose rate of 2 R/h is used for May 1 instead of 350 mR/h, the average external dose for the inhabitants in Usov village becomes about 2 Sv before the evacuation. In this case, the following description in the secret protocols of the USSR Communist is seriously realistic: “By the situation at 9:00 on May 6, the total number of hospitalized reached 3,454 persons. Among them, 2,609 persons are in hospital for treatment, including 471 infants. According to confirmed data, the number of radiation disease is 367 cases, including 19 children.” (from the protocol of the meeting on May 6, 1986).

6. Final remarks

For these 16 years our group has been studying the radiological consequences by the Chernobyl accident, the worst accident in the history of nuclear energy development. We have visited contaminated areas, measured radiation, took samples, discussed with scientists, met people and participated in meetings. Then we clearly understood that the radiological aspect of the accident is only a small part of the tragedy that happened to the people around Chernobyl.

We were overwhelmed by the followings. Just after the accident about 120,000 people were evacuated from the 30 km zone. Several years later, resettlement of much more people began from the highly contaminated areas. The total area for evacuation and resettlement amounted to 10,000 km². About 500 villages and towns within the 30 km zone and in highly contaminated areas disappeared. We can say the local societies have entirely vanished. A recent report [45] indicates that totally 350,400 people had to leave their homes.

We are sure that the Chernobyl tragedy can not be described without referring the pain of these people. We should not consider that the whole aspect of the Chernobyl accident can be revealed by scientific approaches. Of course, the pain of these people is not the direct target of our scientific works. We are thinking that scientific efforts, only by cooperating with other efforts such as films, photos, documentaries, novels and so on, can be successful to draw the whole aspect of the Chernobyl tragedy.

Acknowledgement

The author should be grateful to Koide H., Kawano S., Kobayashi K. and Ebisawa T. of Nuclear Safety Research Group for their encouragement in promoting the present studies. The leadership by late Seo T. should be noted to begin collaborative works with former USSR scientists. This study is supported by Grant-in-Aid for Scientific Research from Japan Society for Promotion of Science.

References

1. Seo T. *et.al.*; "Safety Problems of Nuclear Power Plants. Vol.1", pp.113-131, Nuclear Energy Information Center, Osaka (1976) (in Japanese).
2. Seo. T and Imanaka T.; Discharge of Radioactive Rare Gases by the NPP Accident: In case of TMI-2, *kagaku*, **52** No.1 (1982) 42-52 (in Japanese).
3. Malko M. V.; The Chernobyl Reactor: Design Features and Reasons for Accident, *in this report*, p.11-27.
4. Gorbachev B. I.; The Causes and Scenario of the Chernobyl Accident, and Radioactive Release on the CHNPP Unit-4 Site, *in this report*, p.11-27.
5. USSR State Committee on the Utilization of Atomic Energy; "The Accident at the Chernobyl Nuclear Power Plant and Its Consequences", August 1986.
6. S. A. Khan; The Chernobyl Source Term: A Critical Review, *Nuclear Safety*, **31**, No.3 (1990) 353-74.
7. Seo T., Imanaka T. and Koide H.; Released Radioactivity by the Chernobyl Accident, *Kagaku*, **58** No.2 (1988)108-117 (in Japanese).
8. United Nations Scientific Committee on the Effects of Atomic Radiation; UNSCEAR 1988 Report, Annex D (1988).
9. Imanaka T. *et.al.*; The Final Report of the Research Grant of the Toyota Foundation in 1993 (in Japanese).
10. Minchernobyl; Ten years after the accident at Chernobyl NPP: National Report of Ukraine, 1996 (in Russian).
11. United Nations Scientific Committee on the Effects of Atomic Radiation; UNSCEAR 2000 Report, Annex J (2000).
12. Borovoi A. A. and Gagarinsky A. Yu.; Release of Radionuclides from the Destroyed Reactor at Chernobyl NPP, *Atomnaya Energiya*, **90** No.2 (2001) 137-45 (in Russian).
13. Letter from Legasov to Seo received on January 6, 1988.
14. Imanaka T.; Research Activities of the Nuclear Safety Research Group of KURRI with Belarusian, Russian and Ukrainian Colleagues about the Chernobyl Accident, in "Research Activities about the Radiological Consequences of the Chernobyl NPS Accident and Social Activities to Assist the Sufferers by the Accident", KURRI-KR-21, p.1-4, 1998.
15. Pavlovykh V. M.; Nuclear Fuel in the Destroyed 4th Unit of Chernobyl NPP, *in this report*, p.45-58.
16. M. De Cort and Yu. S. Tsaturov ed., "Atlas on caesium contamination of Europe after the Chernobyl nuclear plant accident", EC/CIS international scientific collaboration, EUR 16542 EN (1996).
17. Nasvit O.; Radioecological Situation in the Cooling Pond of Chornobyl NPP, *in this report*, p.74-85.
18. Gaydar A. and Nasvit O.; Analysis of Radioactive Contamination in the Near Zone of Chornobyl NPP, *in this report*, p.59-73.

19. Stepanenko V. F. *et.al.*; Iodine-131 Contamination, Thyroid Doses and Thyroid Cancer in the Contaminated Areas of Russia, *in this report*, p.86-96.
20. Matsko V. P. and Imanaka T.; Content of Radionuclides of Chernobyl Origin in Food Products for the Belarusian Population, *in this report*, p.105-113.
21. Tykhyy V.; Radioactive Contamination of Food in Stepanivka Village, Zhytomyr Region, Ukraine: in 1992 and in 2001, *in this report*, p.97-104.
22. Ryabov I. N.; Long-Term Observation of Radioactivity Contamination in Fish around Chernobyl, *in this report*, p.114-124.
23. 1990 Recommendation of ICRP, ICRP Publication 60 (1990).
24. Malko M. V.; Chernobyl Radiation-induced Thyroid Cancers in Belarus, *in this report*, p.242-257.
25. Knatko V. A. and Dorzhok I. N.; Estimation of Thyroid Doses from Inhalation of ¹³¹I for Population of Contaminated Regions of Belarus, *in this report*, p.154-161.
26. Knatko V. A., M. M. Komochkov M. M. and Yanush A. E.; Estimations of Radiation Risk for the Population of Contaminated Territory of Belarus, *in this report*, p.162-169.
27. Maksoutov M. M.; Radiation Epidemiological Studies in Russian National Medical and Dosimetric Registry: Estimation of Cancer and Non-cancer Consequences Observed among Chernobyl Liquidators *in this report*, p.11-27.
28. Pryshazhnyuk A. Ye *et.al.*; Review of Epidemiological Finding in Study of Medical Consequences of the Chernobyl Accident in Ukrainian Population, *in this report*, p.190-203.
29. Arynchyn A. N. *et.al.*; Health State of Belarusian Children Suffering from the Chernobyl Accident: Sixteen Years after the Catastrophe, *in this report*, p.233-241.
30. Nyagu A. I. *et.al.*; Intelligence and Brain Damage in Children Acutely Irradiated in Utero As a Result of the Chernobyl Accident, *in this report*, p.204-232
31. Chumak V.; EPR Dosimetry of Chernobyl Liquidators, *in this report*, p.125-143.
32. Ivannikov A., Skvortsov V. G. and Valeri F. STepanenko V. F.; Retrospective Dose Assessment of Inhabitants in the Contaminated Areas of Russia by EPR Measurement of Tooth Enamel, *in this report*, p.144-153.
33. Geraskin S. A. *et.al.*; Cytogenetic Effects of Radiation on Agricultural Plants Observed in the Chernobyl region during the First Years after the Accident, *in this report*, p.289-298.
34. Snigryova G. and Shevchenko V.; Analysis of Chromosome Aberrations in Human Lymphocytes after Accidental Exposure to Ionizing Radiation, *in this report*, p.258-269.
35. Slozina N. M. and Neronova E. G.; he Follow-up Study of Chromosomal aberrations in Chernobyl Clean-up Workers, *in this report*, p.270-278.
36. Bezdrovna L. *et.al.*; Chromosomal Aberrations in Blood Lymphocytes of the Residents of 30-km Chornobyl NPP Exclusion Zone, *in this report*, p.279-288.
37. A. Yaroshinskaya, "Chernobyl: Top Secret", Drugie-berega, Moscow, 1992. (in Russian).
38. A Yaroshinskaya; Impact of Radiation on the Population during the First Weeks and Months after the Chernobyl Accident and Health State of the Population 10 Years Later, KURRI-KR-21, p.104-107, 1998.
39. V. Lupandin, Invisible Victims, *NABAT* **36**, Minsk, October 1992.
40. V. Lupandin; Chernobyl 1996: New Materials concerning Acute Radiation Syndrome around Chernobyl KURRI-KR-21, p.108-113, 1998.
41. T. Imanaka and H. Koide; Dose Assessment for Inhabitants Evacuated from the 30-km Zone Soon after the Chernobyl Accident, KURRI-KR-21, p.121-126, 1998.
42. T. Imanaka and H. Koide; Assessment of External Dose to Inhabitants Evacuated from the 30-km Zone soon after the Chernobyl Accident, *Radiation Biology Radioecology*, **40** (2000) 582-588.
43. I.K.Baliff and V.Stepanenko *ed.*, "Retrospective Dosimetry and Dose Reconstruction", Experimental Collaboration Project ECP-10. EUR 16540, EC, 1996.
44. G. M. Kozubov *et.al.*; The Map-scheme of Radiation Damage of Coniferous Forests in the Region of Accident on the Chernobyl Nuclear Power Plant, Institute of Biology, Komi Scientific Center, Ural Division of USSR Academy of Sciences, 1991.
45. UNDP and UNICEFF; The human consequences of the Chernobyl nuclear accident: A strategy for recovery, 25 January 2002.

The Chernobyl Reactor: Design Features and Reasons for Accident

Mikhail V. MALKO

*Joint Institute of Power and Nuclear Research, National Academy of Sciences of Belarus
Krasin Str.99, Minsk, Sosny, 220109, Republic of Belarus: mvmalko@malkom.belpak.minsk.by*

Abstracts

The report describes the main features of the Chernobyl reactor and possible reasons of the accident that happened on 26 April 1986. Analysis of scientific results established after the accident demonstrates that shortcomings in the design, and freak infringements of safety regulations for the construction as well as inadequate documentation for reactor operation were the main reason of the Chernobyl accident. Various scenarios proposed for this accident are also analyzed in the report. It is concluded that a very high probability of the nuclear explosions at the reactor of the Unit 4 of the Chernobyl accident exists. The power of it could be equivalent to 200 tons of the trinitrotoluene (TNT).

Introduction

The accident at Unit 4 of the Chernobyl Nuclear Power Plant (NPP) on 26 April 1986 is the most severe accident in the history of the peaceful use of the nuclear energy. As a result of this accident the reactor of the fourth unit of the Chernobyl accident was fully destroyed. This caused a release of a very high amount of radioactive species into the environment. The total activity of all radionuclides that escaped from the active core of the reactor during 10 days after the explosions is assessed as approximately 10^{19} Bq [1]. The reasons for the Chernobyl accident and its consequences were the subject of the Post-Accident Review Meeting held on 25-29 August 1986 in Vienna, Austria [2]. It was organized under the auspices of the IAEA. The Soviet experts reported at the meeting their version of the reasons of the accident as well as its possible consequences [3]. The accident occurred during a turbogenerator test carried out at the chance of the shutdown of the unit for a planned maintenance. The destruction of the reactor happened 6-7 seconds after the operator pressed the scram button, AZ-5 to insert all control rods into the core.

According to the Soviet experts the prime cause of the accident at the Chernobyl NPP was "...an extremely improbable combination of violations of instructions and operating rules committed by the staff of the unit" [3]. This conclusion sets a full responsibility for the accident at the Chernobyl NPP on its staff. Participants of the Post-Accident Review Meeting [2] also accepted the Soviet version. However, it was incorrect. This was demonstrated in 1990 by the commission of the State Committee for Atomic Safety Survey of the USSR which concluded that the main reasons of the Chernobyl accident were serious shortcomings in the design of the Chernobyl reactor as well as inadequate documents regulating a safe operation of the reactor [4]. Various errors, that were made during the turbogenerator testing by the personnel of the fourth unit of the Chernobyl NPP, according to the commission, could only contribute to the development of the accident. This commission will be named in the present report as the Sternberg commission after the name of its chairman.

The conclusions of the Sternberg commission were accepted later by the International Consultative Group on the Nuclear Safety that issued in 1993 a Supplement to INSAG-1 [5]. In this report of the International Consultative Group on the Nuclear Safety, the main accent was laid also on various shortcomings of the RBMK design. At the same time the International Consultative Group on the Nuclear Safety indicated that the important reason of the Chernobyl accident was an inadequate "nuclear safety

culture” in the nuclear industry of the former USSR.

Main design features of the RBMK reactor

History of the RBMK

The abbreviation RBMK means in Russian: a channel-type reactor of a large power. There were two modifications of the RBMKs in the USSR: RBMK-1000 and RBMK-1500. They differ only in their capacity. The RBMK-1000 has the nominal power equal 1000 MW electrical gross. The nominal capacity of the RBMK-1500 is 1500 MW electrical gross. Some principal characteristics of the RBMK-1000 are given in Table 1. It is a kind of a boiling water reactor with enriched uranium as fuel, graphite as moderator and water as coolant. Reactors of this type were constructed and operated only in the USSR. The construction of the first RBMK was begun in March 1970 (Leningrad NPP) [6]. It was put into the commercial operation in November 1974. Later other 14 RBMK reactors were constructed and put into operation in the USSR before the Chernobyl accident [6]. Thus, 15 RBMK reactors were in operation in the USSR at the time of the Chernobyl accident. They were 4 reactors at the Leningrad NPP, 4 at the Chernobyl NPP, 4 at the Kursk NPP, 2 at the Smolensk NPP and 1 at the Ignalina NPP [6]. The RBMK reactors were built in pairs, with two units occupying opposite sides of a single building complex. Turbogenerators of such pair of reactor units were constructed in one building. Reactors of the first two units of the Leningrad, Chernobyl and Kursk NPPs belong to the first generation of RBMKs. The other RBMKs belong to the second generation of the reactors of this type.

The difference between RBMKs of the first and second generations was not very significant. All these reactors were practically copies of the first RBMK. They were constructed by using the technical project of the first RBMK reactor that was developed in 1960s [4]. This means that all RBMKs had similar shortcomings and an accident similar to the Chernobyl accident could happen at each Soviet NPP with a channel-type reactor [4].

The first and second units of the Chernobyl NPP belonged to the first generation of RBMKs and the third and fourth units to the second generation. The construction of the Unit 1 of the Chernobyl NPP started in June 1972 [6]. The commercial operation of it began in May 1978. The construction of the Unit 4 started in April 1979 and commercial operation began in March 1984 [6].

Core of the RBMK

The core of the RBMK reactor (element 1 in Fig.1) has a form of a vertical cylinder with an equivalent diameter of 11.8 m and height of 7 m [7]. The schematic presentation of it is given in Fig.1.

Table 1. Principal characteristics of the reactor RBMK-1000 [3].

Characteristics	
Thermal power	3,200 MW
Electrical power	1,000 MW
Fuel enrichment	2.0 %
Mass of uranium in an fuel assembly	114.7 kg
Number of sub-assemblies in an fuel assembly	2
Number of fuel elements in a fuel sub-assembly	18
Diameter of fuel elements	13.6 mm
Fuel burnup	20 MW·d/kg
Coefficient of nonuniformity in radial power density	1.48
Coefficient of nonuniformity in vertical power density	1.4
Maximum design channel power	3,250 kW

The core is constructed from closely packed graphite blocks. They are stacked into columns with vertical cylindrical openings into which channels for fuel (pressure tubes) as well as channels for absorbing rods are inserted. The core is surrounded at top, bottom and lateral by graphite reflectors. The thickness of the lateral reflector is 1 m. The thickness of the top and bottom reflectors is 0.5 m. The weight of the core graphite is 1,700 t. The weight of graphite reflectors is about 300 t.

The RBMKs of the first generation have 1,693 fuel channels (technological channels) and 179 channels for rods of the control and protection systems (CPS) [8]. The RBMKs of the second generation (for example, the Unit 4 of the Chernobyl NPP) have 1,661 fuel channels and 211 channels for the control and protection systems. The fuel assemblies of the RBMK reactor are made in a form of a cluster [7,8]. Each fuel assembly consists of two sub-assemblies, one over the other. The sub-assembly contains 18 fuel elements. The diameter of fuel elements is 13.6 mm. The weight of uranium containing in one fuel assembly is 147.5 kg. The fractions of a pressure tube that are located in the active core are made of zirconium alloy. The lower and upper parts of it are made of steel.

At the time of loading the core with fresh fuel, one part of fuel channels (230-240) is loaded with special *additional absorbing rods* (AAR) because the control rods can not compensate the large reactivity surplus of the core [7]. The geometrical parameters of the AAR rods do not differ from those of fuel assemblies. Therefore, the additional absorbing rods can be inserted at any channel of the core. With increase of the fuel burnup the AAR rods are withdrawn gradually one after the other. The fuel assemblies are inserted then in the channels that were occupied previously by additional absorbing rods. Thus, the weight of uranium in the core increases with increase of fuel burnup. At the beginning of operation it is about 165 t and reaches 192 t by achieving the stationary operation [7].

The graphite stack lays on a base steel plate (element 10 in Fig.1) that is placed on a bottom metal structure (element 3 in Fig.1). The bottom metal structure is a cylinder of 14.5 m in diameter and 2 m high.

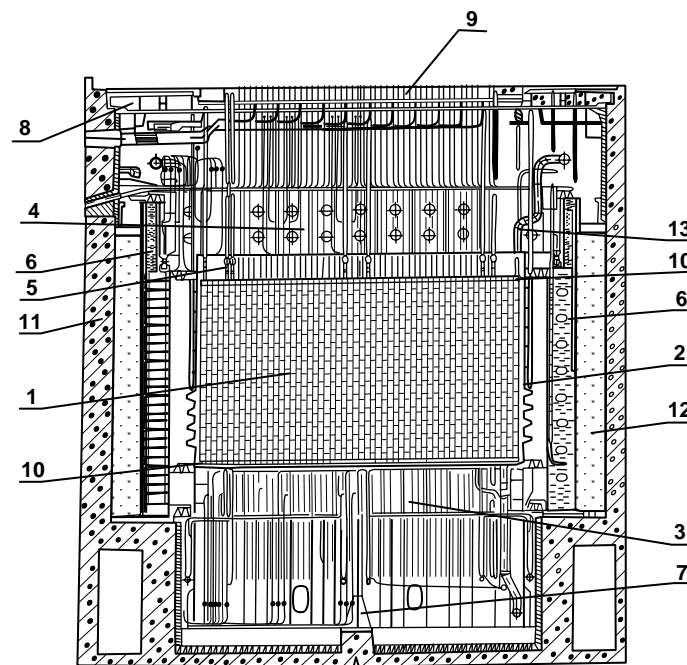

- | | |
|--------------------------------|-------------------------------|
| 1. Core (graphite blocks) | 7. Supporting metal structure |
| 2. Core shroud | 8,9 Operating floor slabs |
| 3. Lower support structure | 10. Steel base plate |
| 4. Upper core cover and shield | 11. Reactor vault |
| 5. Fuel channel duct | 12. Sand filling |
| 6. Annular water tank | 13. Core ventilation pipe |

Fig. 1. The arrangement of the core of Chernobyl Unit 4 [8].

The upper and lower plates of the cylinder are made from steel (10CrNi1Mo) of 40 mm thick [8]. They are welded to the lateral shell by means of leak-tight welds, and welded to each other by means of vertical strengthening fins. The bottom metal structure is mounted on the supporting metal structure (element 7 in Fig.1) that composed of plates with reinforced fins of 5.3 m high. They intersect each other perpendicularly at the center of the reactor [8].

The construction of the top metal structure (element 4 in Fig.1) is similar to the construction of the bottom metal structure. It is a cylinder of 17 m in diameter and 3 m high [8]. The upper and the bottom plates of it are made from steel (10CrNi1Mo) of 40 mm thick. They are also welded to the lateral shell and to each other by means of vertical strengthening fins. The holes in the top and bottom plates are for the tube ducts (element 5 in Fig.1) holding the fuel and absorber channels. The similar ducts for the fuel and absorbers channels are made in the bottom supporting structure.

The space between different tubes and communications in the top and bottom metal structures are filled with serpentinite (a mineral containing bound water of crystallization) [8]. The metal top covering of the core (element 8 in Fig.1) is covered with the removable floor constructed from steel slabs (element 9 in Fig.1).

The lateral side of the graphite stack is surrounded by a cylindrical shroud (element 2 in Fig.1) made of steel sheeting (10CrNi1Mo) of 16 mm thick. It has an outer diameter of 14.52 m and height of 9.75 m [8]. The shroud together with the top and bottom metal structures creates a closed reactor space that is placed into the concrete vault (element 11 in Fig.1). The shroud of the reactor is surrounded laterally by water tanks and sand filling (elements 6 and 12 in Fig.1).

About 5% of the heat generated in the core are released to the graphite stack [3]. This heat is removed to fuel and partially to CPS channel. To reduce a thermal resistance and prevent oxidation of the graphite the cavity in the graphite stack is filled with a slowly circulating mixture of helium and nitrogen. The piping bends of the circulating system of this mixture are shown in Fig.1 (element 13).

System of the RBMK reactor cooling

Cooling of the RBMK reactor is assured with help of two parallel loops [7,8]. They are schematically showed in Fig. 2. Each loop is designed for cooling of one half of the reactor core (the *left and right halves*) and consists of 2 steam separators and 4 main circulating pumps (MCPs). Three main circulating

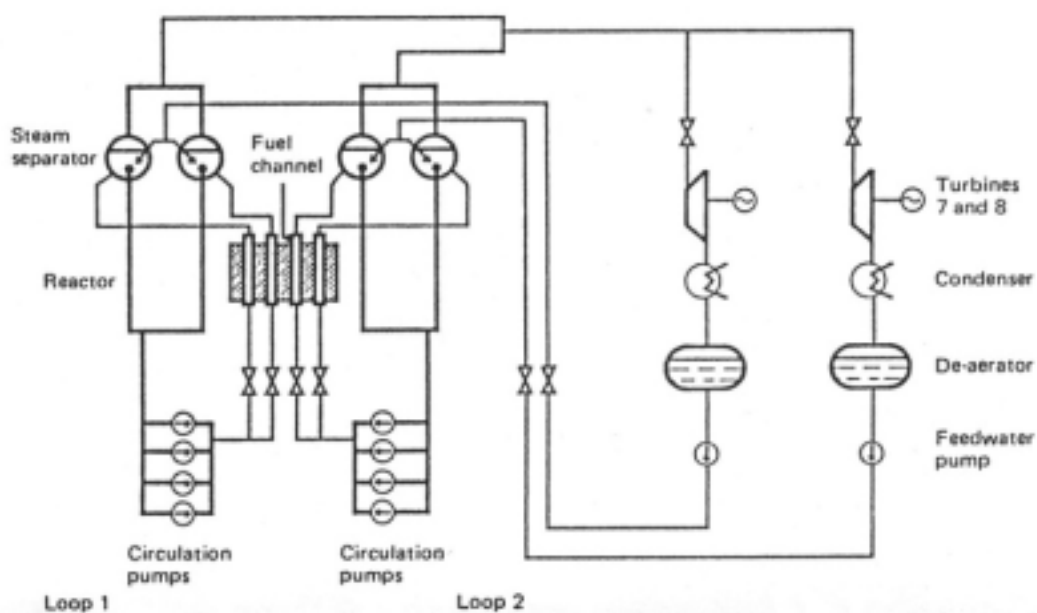

FIG. 2. Schematic diagram of the main water and steam circuits of Chernobyl Unit 4 [2].

pumps are used for normal operation of the reactor. One pump is in a reserve for a breakdown of one of the operating pumps [7,8]. The main circulation pumps of one cooling loop are switched to busbars of the first turbogenerator of the unit. The main circulation pumps of other loop are switched to busbars of the second turbogenerator of the unit.

The coolant (light water) enters the fuel channels from the bottom of the core. The inlet pressure and temperature are 8.2 MPa and 270 °C, respectively [8]. By passing of the channel the pressure of water decreases to approximately 7 MPa and temperature increases up to 284.5 °C at the core outlet. The increase of the temperature and the decrease of pressure cause boiling of water. This process begins at the distance approximately 2.5 m from the inlet to the core [7]. At the outlet of the core, steam content reaches the value of to 14.5 wt%. This steam-water mixture flows into steam separators, where it is separated into saturated steam and water. The separated steam flows then to the turbines and after passing of them goes to condensers where it is condensed to water. This water (feed water) is then pumped by electrical feed water pumps to steam separators. Here the feed and separated out water is mixed together. On this way the temperature of the separated out water decreases to 270 °C. This provides the necessary cavitation margin required for operation of the main circulating pumps and boiling of water at the inlet to the core (the saturation temperature of water at the pressure at the inlet to the core is about 284 °C).

At normal operating circumstances, each of the 6 main circulating pumps can work with flow-rate about 7,000 t/h [8]. Their operating with higher flow-rates at the stable power output of the reactor is not desirable. Such operation causes a change of the relation between the mass of feed water and the mass of water separated out in steam separators. The average temperature of the mixture of feed and the water separated out water increases in this case and this causes a decrease of the cavitation margin. This can cause cavitation of the main circulating pumps and boiling of the coolant even at the inlet to the core. The same situation arises in case of operations of the main circulating pumps at their nominal flow-rates when reactor is operated at decreased power.

In case of the RBMK the coolant flows separately to each fuel channels. This requires an individual regulation of flow-rate to each fuel channel. Therefore, the thermohydraulic scheme of the reactor is much more complicated than PWRs and BWRs.

Control and protection system

The control and protection system (CPS) of the RBMK reactor has absorbing rods and different measuring devices for a control of a number of parameters. There are 211 absorbing rods in case of the RBMK reactors of the second generation [3,4]. According to their functions they are divided in 4 groups [7]:

- shortened absorbing rods (SAR) for regulation of the axial neutron distribution;
- absorbing rods for a manual regulating of the radial neutron distribution (MR);
- absorbing rods for an auto control of the reactor power (AC);
- emergency rods (ER).

The total numbers of the SAR, AC, MR and ER absorbers are 24, 24, 139 and 24, respectively [4]. The absorbing rods used for control and protection systems of the RBMK reactor are assembled from the identical absorbing elements made of carbide boron [7]. These elements have the same length equal to 967.5 mm. The absorbers of the type SAR have only three absorbing elements. Their length is 3,050 mm [7]. Other absorbing rods are assembled from 5 absorbing elements. Their length is 5,120 mm [7]. There are another feature in absorbing rods of the RBMK reactor. The absorbing rods of the type SAR, MR and ER have special graphite displacers that are assembled from 5 graphite elements. These displacers remain in the core by full withdrawal of absorbing fractions of rods. The use of graphite displacers improves significantly the neutron economy of the RBMK reactor because graphite absorbs neutrons much less than the light water. Fig.3 demonstrates schematically different absorbers of the control and protection systems

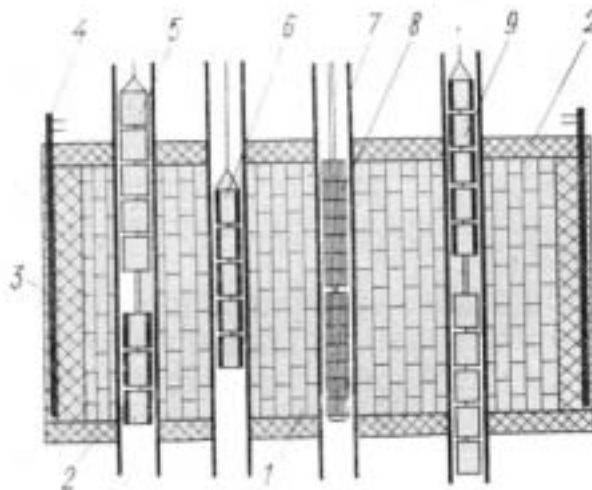

FIG. 3. Structure of the core [7].

- 1 - graphite stack; 2 - bottom reflector;
- 3 - lateral reflector; 4 - channel of lateral reflector cooling;
- 5 - shortened absorber rod (SAR);
- 6 - auto control rod (AC); 7 - fuel channel (technological channel);
- 8 - fuel assembly;
- 9 - manual regulation absorber (MR) and emergency absorber (ER).

of the RBMK reactor.

Negative features of the RBMK reactor.

The RBMK reactors have a number of negative features that strongly influence the safety of their operation. Some of them were eliminated after the Chernobyl accident. However, we shall discuss here the negative features of the RBMK reactor that existed before the accident.

One of them is an enhanced sensitivity of neutron fields to the moving of control rods [7]. This effect is caused through a big number of absorbers in the core for compensation of a large reactivity surplus. By withdrawal of some absorbers, especially absorbers in peripheral zones, a local criticality is also possible. According to [7], it can appear in the zone consisting of 15 - 20 channels loaded with fuel when there are no one absorber among them. These features of the core cause significant problems in controlling of the RBMK reactors in comparison to PWRs and BWRs.

Another significant problem creates the large positive steam-void coefficient of the RBMK reactor. Experimental studies carried out at the end of 1970s have shown that the steam-void coefficient increases up to $5 \beta_{\text{eff}}$ by decreasing of the number of additional absorbing rods (AAR) in the core and by increasing of the fuel burnup [4]. Appearance of such large positive reactivity decreased the period of the power stabilization of the core to 3 minutes [4]. This made the safe operation of the RBMK reactor quite problematic. A special local auto-control system was developed in order to prevent uncontrolled power excursions. It was clear already in 1970s how to decrease the high steam-void coefficient [4]. It disappears by introducing of a certain number of additional absorbing rods in the core. The permanent presence of them in the core required fuel with a higher enrichment. Therefore, from 1970s the enrichment of fuel used for RBMKs was 2 % instead of 1.8 % used at the beginning of the operation of the first RBMK (reactor of the Unit 1 of the Leningrad NPP). It was found later that the enrichment of fuel up to 2 % was not enough for decreasing of the steam-void coefficient [4]. Experimental studies carried out at the end of 1970s has shown that only by enrichment 2.4 % and by the permanent presence of about 80 additional absorbers in the core the value of the steam-void coefficient could be made less than β_{eff} . These data were also confirmed in a experimental study carried out after the Chernobyl accident [9]. However, the use of

additional absorbers and fuel with higher enrichment was implemented for RBMKs only some years after the Chernobyl accident.

The significant shortage was also in the design the SAR, MR and ER absorbers of the RBMK reactor. These absorbers had special graphite displacers in the length of 4.5 m [10]. By a withdrawal of the SAR, MR and ER absorbers up to their extreme top position above the core, the midpoint of each displacer is at the midpoint of the core. Because their length (4.5 m) is less than the height of the core (7 m), the water columns in the height of 1.25 m are formed below and above the displacers. On moving down of absorbers into the core, their displacers displace water columns from the lower part of the core. Thus, inserting of absorbers from their extreme top position introduces a positive reactivity into the core because graphite absorbs neutrons much less than water. This effect of absorber displacers is shown in Fig. 4. It was known by operators of RBMKs. They named it the “end-rods effect”. Specialists named the “end-rods effect” as the positive reactivity surge. It was not fully understood by them because it appeared occasionally and only by some neutrons distributions in the core. For example, in one document of the Chief Designer organization it was told that the positive reactivity surge could appear only in case of neutron field disturbed downwards [10]. This statement was wrong. It is known that before pressing the button AZ-5 the neutron field was distorted upwards and not downwards. This fact says about misunderstanding by the Chief Designer organization of the real nature of the positive reactivity surge caused by inserting of absorbers from their extreme top position.

The situation with the control and protection systems of RBMKs became complicated because of a very low speed at which the control and emergency rods could be inserted into the core from their extreme top position. The speed was only 0.4 m per second. Thus, they could be fully inserted into the core for 18-20 seconds [4,9]. Such protection system was not able to shut down the reactor in cases, when the excursion started. In such situation, the reactor period can be in order of some seconds.

The additional problems of RBMKs arise from a very complicated system of the core cooling and the use of the coolant that can change its physical state in the core.

Accident at the Unit 4 of the Chernobyl NPP

Chronology of the accident

The accident at the Unit 4 of the Chernobyl NPP occurred on 26 April 1986. This unit had to be shutdown on 25 April 1986 for the planned maintenance. Before the shutdown, it was planned to study the possibility of utilization of the mechanical energy of a turbogenerator after cut-off of steam supply, in

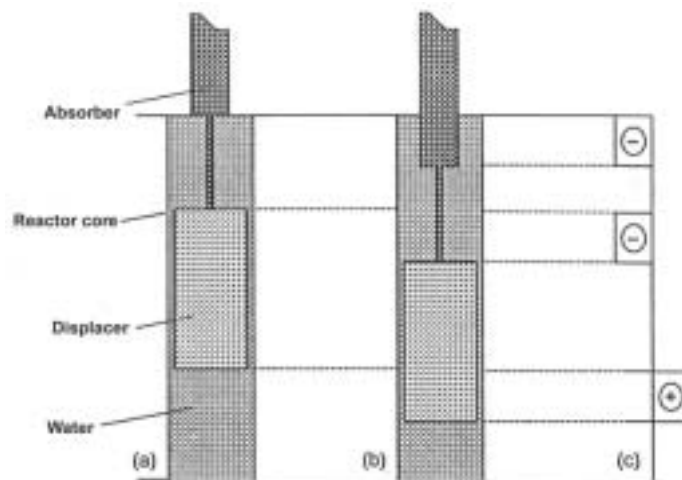

FIG. 4. Schematic presentation of the reactivity inserted by moving of CPS absorbers from their extreme top position.
 (a) manual regulation rod is withdrawn;
 (b) manual regulation rod is at the initial insertion stage;
 (c) schematic presentation of the change in the reactivity by insertion of the rod [5].

order to ensure the power requirements in a case of a power failure [3]. This test had to be carried out at the power level 1,000 –700 MW thermal. The decrease of power began on 25 April 1986 at 01 hr 06 min. The reactor had at this time the nominal power 3,200 MW thermal (the time and other data are given here and below after records of the operator in the operative log-journal) [4]. At 03 hr 47 min the reactor power reached the level of 1,600 MW thermal. It fell to the value 1,500 MW thermal by the time 04 hr 13 min. The reactor was operated at this power until 12 hr 36 min. The operation reactivity surplus (ORS) beginning from 07 hr 10 min decreased to 13.2 manual absorbing rods (MR). At 13 hr 05 min, the turbogenerator TG7 was switched off. Four main circulating pumps, two electrical feed water pumps and other equipment that was connected with this turbogenerator were switched to the busbars of the turbogenerator TG8.

The following pump configuration arose as a result of these actions: four pumps running from the turbogenerator TG8 (MCP-13, 14, 23, 24), two pumps running from grid (MCP-12, MCP-22) and two pumps (MCP-11, MCP-21) connected to grid on standby. At the foreseen experiment the pumps MCP-13, MCP-14., MCP-23 and MCP-24 had to run together with the turbogenerator TG8. The main circulating pumps: MCP-11, MCP-12, MCP-13, MCP-14 belonged to the loop for cooling of the left half of the core. The main circulating pumps: MCP-21, MCP-22, MCP-23, MCP-24 belonged to the loop for cooling of the right half of the core.

At 14 hr, the emergency core cooling system (ECCS) was switched off according to the experiment program. At this time, the Kiev dispatcher of the electrical grid ordered to continue the operation of the Unit 4 because of a shortage of power [4]. From this time the reactor was operated at the power 1,500 MW thermal with the switched-off ECCS system. The order of the Kiev distributor caused an important disturbance for the test because the later continuation of the experiment had to be done by another shift of the Unit 4 that was not planned for this important work.

At 23 hr 10 min, the operator of the reactor was allowed to decrease the power of the unit. At 00 hr 10 min on 26 April, it reached the level 720 MW thermal that was the lower limit of the power according to the experiment program [4]. However, the operator could not stabilize the power of the reactor at this level. It continues to fall and at 00 hr 28 min, it fell down to 30 MW thermal. The operator of the reactor, the senior engineer, Leonid Toptunov and the shift foreman, Alexander Akimov decided to insert absorbing rods in the core in order to shutdown the reactor. They were forced by the deputy chief engineer for operation of Unit 3 and Unit 4, Aleksander Dyatlov to withdraw the absorbers out the core in order to increase the power of the reactor [11]. The latter wished to carry out the planned test at any price. The necessity of the withdrawal of practically all absorbers out the core was dictated by a very strong xenon poisoning as a result of very quick decrease of the reactor power.

After the withdrawal of a number of absorbers, the power of the reactor began to increase. At 01 hr 03 min, it reached 200 MW thermal [4]. At this time 2 reserve circulating pumps were put additionally into operation. The total number of operating main circulating pumps reached 8 pumps. Therefore, the summary flow-rate of water through the core became higher than at the nominal power of the operation. Such increase in the summary flow-rate of the coolant was reached at very low reactor power and very low steam generation. This caused the decrease in a cavitation and boiling surplus. According to [4], it was only about 3 °C. Thus, the withdrawal of the majority of absorbers from the core after the fall of the power to 30 MW thermal put the reactor into an unstable thermo-hydraulic state.

The use of two additional main circulation pumps after reaching of the thermal power 200 MW was undertaken in order to guarantee a safe cooling of the reactor after finishing of rundown of the turbogenerator TG8 and 4 main circulating pumps connected to busbars of it (MCP-13, -14, -23, -24). Four circulating pumps (MCP-11, -12, -21, -22) had to remain after finishing of the rundown. Performing some actions the operating staff could bring the reactor in a stable state before the experiment beginning [3,4]. An analysis carried later shown that no signals appeared indicating that something happened with

the reactor that could hinder conducting of the experiment [4]. It seemed for the operating staff that the reactor was in the normal state. This was a very serious mistake. In reality, the reactor was in a very dangerous state. At 01 hr 22 min 30 sec, the operative reactivity surplus was only 8 rods [4]. It means that the water in the core, especially in its lower part, became the most important absorbers of neutrons. A decrease of a pressure or an increase of a temperature of water at the inlet to the core could cause a local boiling of water in the lower part of the core. Such process inserts the positive reactivity and as a result of a large positive power coefficient causes a high increase of the reactor power. Unfortunately, the operator did not understand this dangerous feature of the Chernobyl reactor and continued to operate the reactor in this dangerous state.

At 01 hr 23 min 04 sec, the experiment was started. At this time, the emergency regulating valves of the second turbogenerator, TBG8, were closed [3,4]. The power of reactor was 200 MW thermal. The operative reactivity surplus was only about 6-8 absorbers. This was shown by the analysis carried out after the accident. Shortly after the beginning of the experiment, the reactor power began to rise [3,4]. At 1 hr 23 min 40 sec, the unit shift foreman gave the order to press the button AZ-5, which would send all control and scram rods into the core [3,4]. The rods began to move into the core. However, after several seconds a number of shocks were felt and the operator saw that the absorber rods had halted without plunging fully to the lower stops. Seeing this stop of absorbers the shift foreman cut off the current to sleeves of the servo drivers of absorbers in order to ensure the falling of rods [11]. -- This action did not help to insert the rods into the core. Some seconds later the reactor was fully destroyed.

According to observers that were outside of the Unit 4, at least 2 explosions, one after the other occurred in the reactor at 01 hr 24 min on 26 April 1986 [3]. Here is a story of one fireman that heard several explosions at the time of the experiment [11]: "At the time of the explosion I was near to the dispatcher bureau. I was in service. Suddenly we heard a loud clap of steam. We did not take into consideration this event because throws of steam into atmosphere were quite often. I wanted to leave the room for my rest and heard at this moment an explosion. I ran to the window and heard in a very short time the other explosions." This story was recorded in the clinic in Moscow where the affected fireman and personnel members were treated because of the acute radiation sickness.

Another observer (a concrete worker of the Chernobyl NPP) told the following story [10]: "I was near the Unit 4, about 500 meters away, when I suddenly heard a loud clap. Then came something like the sound of an explosion. I thought it was the steam valve, which we used to hear from time to time. Then in a couple of seconds a bright, blue flash was followed by an enormous explosion. When looking at the Block 4, I saw that there were only two walls of it left. The structure was in ruins, water was pouring out, bitumen was burning on the roof of the Unit 4"

Destruction of the reactor

The explosions at 01 hr 24 min completely destroyed the core of the reactor of the Unit 4 [12]. Walls and the ceiling of the central hall were demolished. Ceilings of the premises of the steam separators were displaced and walls were destroyed. Premises housing the main circulating pumps as well as two stories of the de-aeration stack were demolished. The reactor emergency cooling system was completely destroyed from the north side of the reactor building and buried with frame details. The upper metal structure together with top covering (the summary weight 2,000) and rests of the steam-water system were thrown into vertical direction and fell on the rib with the inclination angle 15° [12]. The artist picture in Fig. 4 shows its position after the explosions as well as the scale of the reactor destruction. The lower metal structure after the explosion went down by 4 m lower than their initial position, crushing the supporting constructions and pulling the water pipeline system. The southeast quadrant of the lower metal structure does not exist. It was destroyed during the accident. The reactor space is empty. It does not contain any more or less large fragments of the reactor laying [12].

In addition to destructions listed here, many other premises and constructions were demolished too. By destruction of the reactor a large amount of core materials were thrown out the core [13]. Large pieces of graphite and whole graphite blocks, fragments of fuel channels and fuel assemblies could be found even in big distances from the reactor [13]. Practically the whole site of the Chernobyl NPP as well as all rooms of the reactor was covered with the graphite dust.

Physical nature of explosions

Soviet experts who participated at the Post-Accident Review Meeting in Vienna suggested the following hypothesis of the physical nature of explosions that demolished the Unit 4 of the Chernobyl NPP. According to them, the first explosion was a steam explosion [3]. It had to occur on the following scenario. A very fast and high increase of a heat generation occurred in the core. It caused an intensive steam formation and then a nucleate boiling. Soon, the melting of cladding and fuel as well as destruction of fuel tablets into small particles followed. Then the destruction of fuel channels occurred. The next step was a very massive steam generation because of contacting of the destroyed fuel with water. This caused a first explosion in the core because of a very high steam pressure. It can be named as a *steam explosion*. Later a number of explosions followed as a result of exothermic reactions in a mixture containing hydrogen formed in the water-zirconium process and carbon monoxide formed by a fire of graphite.

The hypothesis about the steam explosion was accepted by specialists [4,14]. However, the assumption about the role of exothermic chemical reactions in the mixture of hydrogen, carbon monoxide etc was not discussed more. It was shown in special model experiments carried out after the Chernobyl accident that the role of them was negligible [13].

Some specialists are sure that after the steam explosion a nuclear explosion similar to an atomic bomb explosion occurred in the core of the 4th Unit [13,15,16]. Its power had to be much higher than

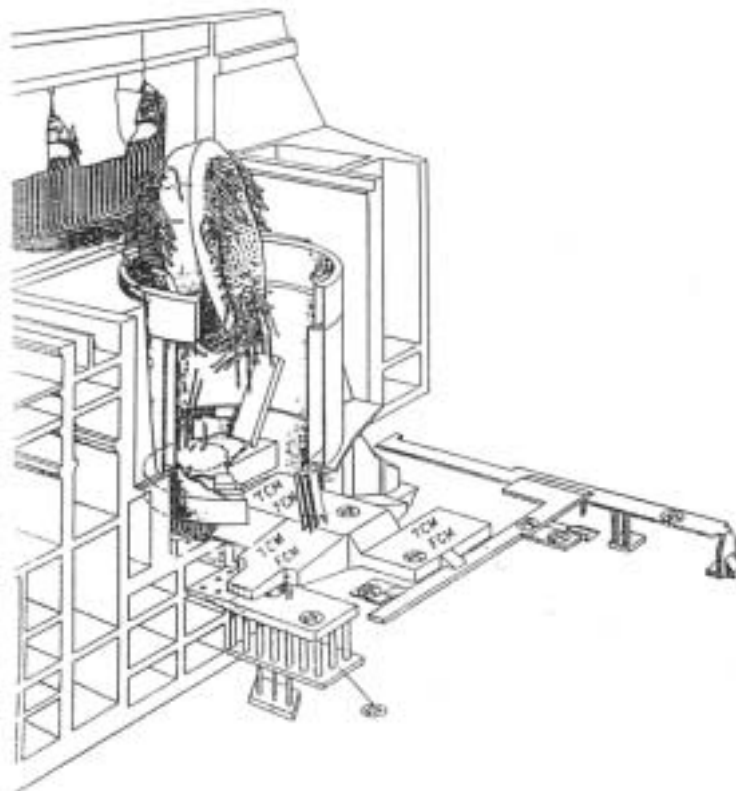

FIG. 5. The state of the reactor section of Unit 4 after the accident (the cut-away view): FCM - fuel containing masses [12].

power of the steam explosion.

The conclusion of the authors [15] is based on experimental findings established by studying of activities of isotopes ^{133}Xe and $^{133}\text{Xe}_m$ in the air that existed in the first days after the Chernobyl accident. Their study was carried out in the city Cherepovets that is about 1,000 km in north direction from the Chernobyl NPP. The authors [15] could find that the ratio of activities of these isotopes is the same as in the case of nuclear explosion.

Two different models of the nuclear explosions are known. According to [13], the core of the Chernobyl reactor transformed to a turbo-jet solid-phase engine after a very short initial overheating of fuel. It flew like a missile from the reactor vault to the central reactor hall by the hydrodynamic forces of gas-phase streams flushing down from the fuel channels. Then it exploded as an atomic bomb in the space of the central hall. Practically, the whole fuel and graphite had to be thrown away from the reactor by this explosion. This hypothesis explains a number of questions. For example, it explains why there is no fuel in the vault. It gives an answer on the question why the metal shroud of the core could be in the central reactor hall. It is situated now in the central reactor hall 35 meters from the entry to the reactor vault. This finding was established in 1995 [13]. The hypothesis [13] makes also clear how could remain without any visible demolishing the paint on the lower surface of the upper metal structure that stays now on its rib in the vault. This paint is able to sustain only up to 300 °C. In a case of graphite burning during a long time, it had to be destroyed. This is a reason for authors [13] to reject the possibility of graphite burning in the core after explosions. Their hypothesis seems quite reliable because it explains a number of other findings established some years after the accident. At the same time, it can not explain some very important facts. For example, it is well known that radioactive substances escaped from the destroyed reactor with a quite constant release during 10 days after the accident. This had to be only in a case when significant amounts of fuel and graphite remained after the explosions and a long term fire of graphite was in the core.

Data on composition of radionuclides deposited in the areas contaminated by the accident indicate also the presence of large amounts of fuel in the core after the explosions that destroyed the Chernobyl reactor. In case of a scenario proposed by [13], no fuel and graphite could remain in the core. This means that the radioactive contamination of territories affected by the Chernobyl accident had to be caused by radioactive substances discharged to the environment only during the explosions. However in this case, radionuclides, deposited at any place of the world, had to have the same composition as the composition in the core before the accident. Let's consider here only one example. According to [1] 280 PBq of the isotope ^{137}Cs and 200 PBq of the isotope ^{90}Sr were in the core of the Unit 4 before the accident. Their half-lives for the radioactive decay are quite similar. Thus, at any place of the world the ratio of the ^{137}Cs concentration to ^{90}Sr concentration has to be equal to 1.4. However, reliable experimental data [17] show that such values of this ratio exist only in areas close to the Chernobyl NPP. They increase up to 100 in areas that are more than 100 km from the Chernobyl NPP. These high ratios of ^{137}Cs concentration to ^{90}Sr concentration indicate that the discharge of radioactive substances into the environment had to be caused not only by explosions but also mainly as a result of fuel melting in the reactor core. This means that a significant part of fuel had to remain in the reactor after explosions. This could happen when only a part of fuel was thrown from the core by the nuclear explosion, for example, in case when the nuclear explosions occurred only in one part of the core. The last assumption explains why only one segment of the lower metal structure was destroyed.

Another model of the nuclear explosion was proposed by authors [16]. According to them, soon after the beginning of the experiment a sudden boiling of water occurred in the core. It was caused as a result of depressurization and flow rate reduction of the coolant. The introduced positive reactivity was higher than the anti-reactivity Doppler margin. Therefore, the fuel reached the enthalpy of disaggregation just being able to quench the first reactivity trip. Some tenth seconds after this first power burst, the energy deposited initially in the fuel was transferred to the water. This process was very fast and the heat transmission to the

water was so high that convective streams could not develop within the water. The steam film and bubbles formed on the cladding. The internal pressure of the bubbles increased so rapidly that the water was expelled from the reactor. This was the first explosion (steam explosion). It caused a demolishing of coolant communications. The reactor became dried and more reactive than the wet one, and a new power burst occur. The authors estimated the energy of the last power burst to be 1.0 TJ. This energy is equivalent to the energy of explosion of approximately 200 tons of the trinitrotoluene [18]. Similar estimations were established also in the reports [13,15]. Western specialists claimed after the Chernobyl accident that the catastrophic consequences of this accident were caused because an absence of the containment of the Chernobyl reactor. However, it is clear that there is no such containment in the world that can sustain to such explosion.

The assumption about the nuclear nature seems reliable. It allows to explain some facts, for example, the observation of the witness that saw “a bright, blue flash” over the reactor of the Unit 4 and heard “an enormous explosion” at 1 hr and 24 min [10]. It is known that the blue light corresponds to the temperature about 6,000 °K. Such temperature can not appear at the steam explosion. It is also clear that in case of the steam explosion a gray ball of steam and graphite dust had to appear over the building but not a blue flash.

It is evident the hypothetical character about the possibility of the nuclear explosion in the core of the Chernobyl reactor despite of its seeming reality. It is necessary to carry out more detailed studies in order to establish a conclusion about its possibility.

Main reasons of the accident

According to the Soviet participants of the Post-Accident Review Meeting in Vienna severe violations made by the personnel of the Unit 4 of the Chernobyl NPP on 25-26 April 1986 were the main reasons of the Chernobyl accident [3]. As especially serious violations were named the following:

- operation of the reactor at a very low operative reactivity surplus (ORS),
- conducting of the experiment by the power below the level provided for test,
- blocking of the protection system relaying on water level and steam pressure in steam-separators,
- blocking of the protection system relaying on shutdown signal from two turbogenerators,
- connection of all the main circulating pumps to the reactor,
- switching off the emergency core cooling system (ECCS).

The Sternberg commission [4] recognized only the first violation from given above. It stated that in accordance with existing technological regulations the operator had to shut down the reactor already at 07 hr 10 min on 25 April 1986. The power of the reactor was then 1,500 MW thermal and the OSR was 13.2 rods. The existed technological requirements for operation of the Unit 3 and Unit 4 required the shutdown of the reactor when the operative reactivity surplus decreased to such value at such power level. The operator did not fulfill this requirement. However, the Sternberg commission stated that this violation could not initiate the accident or influence it [4]. Records made by the operator in the operative logbook show that at 23 hr 10 min on 25 April 1986 the ORS value was 23 full rods. This means that in the period from 07 hr 10 min to 23 hr 10 min the reactor of the fourth unit was brought in accordance with technological requirements.

The Sternberg commission noticed at the same time that this violation was possible because of very unclear operation's requirements existing in the USSR before the Chernobyl accident. For example, there were no documents before the accident indicated the ORS as an important technological parameter. Additionally, such equipment that could establish operative value of the ORS in a short time did not exist as a whole. The operator had to establish at first fractions of absorbers inserted into the core. Then he had to calculate the effective number of rods fully inserted in the core. The operator could also receive this

information by using the computer of the reactor unit. In this case, he needed to wait 7-10 minutes for estimation of the operative reactivity surplus. These procedures for an operative estimation of the OSR value indicate clearly that the ORS was never considered as a factor determining the safe operation of the RBMK.

The Sternberg commission concluded that all other violations of the personnel named by Soviet experts did no influence on the initiation and development of the Chernobyl accident. Let us consider, for example, the switching off the emergency core cooling system. Data recorded by the reactor control systems show that no emergency signals came to the ECCS system during the development of the accident. They could not come because the sensors of the emergency core cooling system reacts on the events in the premise compartments, but not on the events in the core. This means that there was no difference, was this system switched off or in.

The analysis of the Commission demonstrated also that some violations of the Chernobyl NPP staff were done because of a very poor regulations and instructions developed for operators of RBMKs by designers of this reactor. The Sternberg commission could demonstrate that the Chief Designer of the RBMK reactor was not able to understand clearly some negative features of the reactor, especially by operation at low power

There is no doubt that severe shortage in the design of the RBMK and freak infringements of safety regulations by construction of the Unit 4 are real reasons of the Chernobyl accident [4].

It is also evident today which physical factor caused the accident at the Unit 4 of the Chernobyl NPP. This factor was the large positive reactivity inserted into the core. However, it is unclear up to present what kind of initiating factors could cause this event.

Some specialists believe that the Chernobyl accident was triggered by pressing of the emergency button AZ-5 [4,17]. According to them, the accident developed after the following scenario. After pressing of the button AZ-5 all absorbers for the manual regulation and all emergency absorbers began to move into the core. Before the pressing of the button AZ-5 the summary lengths of all absorbing elements that were in the core was approximately worth 6-8 rods of full insertion into it [3,4]. By moving of all these absorbers down the water columns under the graphite displacers were displaced out the core. This caused the entry of the positive reactivity into lower part of the core.

In this case, the question about the responsibility for the Chernobyl accident is very easy to answer. It is clear that the Chief Designer organization is responsible when the pressing of the button AZ-5 triggered the accident. It designed such protection system that can introduce the positive reactivity into the core followed by fast increase of power instead of the negative reactivity required for the shutdown of the reactor. This means that a freak infringement of safety regulations was made by this organization for construction of the Unit 4 of the Chernobyl accident. According to these regulations, the control and protection systems have to be able to shut down the chain reaction at any circumstances.

On the contrary, the authors [16] believe that the pressing of the button AZ-5 did not play any role in initiating of the Chernobyl accident. According to them, the boiling of water in the lower part of the core caused because of the unstable thermo-hydraulic regime of the coolant flow was the initiating factor. There was an unstable thermo-hydraulic regime of the reactor before the accident. The temperature surplus for water boiling was very small at least in case of some fuel channels. This could cause the water boiling in the lower part of the core and introducing the positive reactivity into it. This caused an excursion of the power in the lower part of the core and a very high release of heat in fuel channels. The pressing of the button AZ-5 in this case had only a secondary meaning. It only added an additional positive reactivity to the lower part of the core.

The hypothesis of [16] explains the reason for pressing of the button AZ-5 by the operator of the Chernobyl NPP. We believe that he pressed this button because he could see a very rapid increase of power. Other reasons for pressing of the button AZ-5 are less probable.

Computer simulations made on the basis of more sophisticated codes [19,20] shown that acceptance only one hypothesis that were described above can not explain the development of the Chernobyl accident. They both have to be concerned in order to carry out the correct evaluation of the accident

An interesting assumption was proposed by Checherov [21]. He worked during some years as a head of the laboratory for fuel studying of the accidental unit of the Chernobyl NPP. Later he was a head a department for reconstruction of the accident reasons. Checherov could find that electric motors of the main circulating pumps of the Chernobyl NPP had the internal protection for a decline of frequency and voltage. This protection disconnects electrical motors of the MCPs in 30 seconds after the decrease of the frequency to 45 Hz and in 0.5-1-5 seconds after the decline of voltage to the level of 75% of its nominal value. Checherov [21] believes that as a result of the decrease of the frequency and voltage of the current of the turbogenerator TG8 approximately at 1 hr 10 min 40 sec electrical motors connected to busbars of the turbogenerator TG8 were disconnected by the signals of the internal protection of the electrical motors of the MCPs that participated at the run down experiment. This caused a significant drop in the pressure at the inlet to the core and boiling of water in its lower part. This caused an inserting of the positive reactivity and a large power excursion in the lower part of the core and the first explosion.

In the light of above discussed discrepancies, it is clear the necessity to carry out the further study of the initiating factors of the accident.

Discussion

The analysis of information on the main features of the design of the RBMK reactor indicated that a number of shortages and a low safety culture in the USSR caused the accident at the Chernobyl NPP on 26 April 1986. The infringements of operation regulations made by the personal of the Unit 4 could only contribute to the scale of the accident. It was very possible that the most severe destructions of the reactor were caused by the nuclear explosion that happened after the steam explosion.

The Chernobyl accident was practically “planned”. Its roots lay in the history of the RBMK development. The RBMK design was developed by the same organizations and specialists that were involved in the development of the Soviet nuclear weapon. Therefore, the same level of secrecy was brought in the development of nuclear power reactors for electricity generation. It was forbidden in the USSR to make public any information about incidences even at foreign NPPs. The former deputy head of the department for the NPP construction supervision in the USSR Ministry of Power, Grigorii Medvedev remembered that the technical information about the accident at the Three Mile Iceland NPP was classified in the USSR [11]. No information was published in the USSR as a whole about various incidences and accidents at the Soviet NPPs. On the contrary, it was said every time that the Soviet NPPs were the safest in the world. Such statements were totally incorrect. A number of severe accidents occurred in the USSR before the Chernobyl accident [11]. They are listed below.

- ✧ On 7 May 1966, an accident occurred at an experimental boiling water reactor in Melekess (near to the city Gorjkii, now Nizhni Novgorod). In case of this accident, a power excursion appeared because of chain reaction by prompt neutrons. The operator and shift foreman received high doses of irradiation.
- ✧ During 1964 – 1979, a series of destruction of fuel channels occurred in the reactor of the Unit 1 of the Beloyarsky NPP. The reactor of this NPP was of a channel-type reactor quite similar to the RBMK. These accidents caused every time a significant irradiation of the personnel.
- ✧ On 7 January 1974, an accident happened at the Unit 1 of the Leningrad NPP. In case of this accident, a ferroconcrete gasholder of the system to retain radioactive gases was destroyed. There were no victims by this accident.
- ✧ On 6 February 1974, a rupture of the intermediate circuit of the Unit 1 of the Leningrad NPP occurred

because of water boiling in it. Three persons were killed by this accident. High radioactive water together with radioactive sludge of the filter powder was discharged into the environment.

- ✧ In October 1975, a partial destruction of the core of the Unit 1 of the Leningrad NPP occurred. The reactor was shut down and the core was cleaned on the next day after the shutdown by pumping of an emergency reserve of nitrogen through the core to the ventilation chimney. Consequently, approximately 1.5 million Curie of radioactive substances was discharged into the environment.
- ✧ In 1977, 50% of fuel channels were melted in the core of the Unit 2 of the Beloyarsky NPP. The reactor of this NPP was of a channel-type also quite similar to the RBMK. Repairing of the reactor was about 1 year long. The high irradiation of the personnel occurred.
- ✧ On 31 December 1978, a large fire at the Unit 2 of the Beloyarsky NPP. The fire was initiated through a downfall of a covering plate of the powerhouse hall on the turbine oil tank. 8 persons received high doses during an organization of the core emergency cooling.
- ✧ In September 1982, a fuel channel in the center of the core of the Unit 1 of the Chernobyl NPP was destroyed as a result of mistakes made by the personnel. A large amount of radioactive substances was released to the industrial site of the NPP and the city Pripyat. The personnel involved in the liquidation of the consequences of this accident received high irradiation doses.
- ✧ In October 1982, the generator of the Unit 1 of the Armenian NPP exploded. The hall for the turbogenerator burnt down. The main part of the personnel of the NPP simply fled from the plant leaving it in the emergency state. The special operative group of specialists from the Kolsk NPP flew by an airplane and helped to save the Armenian NPP.
- ✧ On 27 June 1985, an accident occurred at the Unit 1 of the Balakovo NPP. One secure valve of the cooling circuit was pulled out. Therefore, the water steam at the temperature 300 °C came to a room where people worked. 14 people were killed by this accident. The accident happened because of an unusual tempo of the work and because of low experience of people.
- ✧ In August 1985, a severe accident happened in the bay near Vladivostok when reloading submarine reactors [22]. This time, a water-water type reactor exploded. 10 people were killed by the accident. The spontaneous chain reaction with a high release of energy arose. It caused a prompt evaporation of the coolant. As a result of the explosion, the core with the fresh fuel was thrown to the pier. This accident demonstrated clearly that water-water nuclear reactors can explode too.

Unfortunately, the information about these and other accidents was accessible only for high authorities. The Soviet government forced the construction of nuclear power plants because this energy source was considered in the USSR as a sign of the technological development. This practice did not allow the Soviet specialists to improve the safety of nuclear powers. Such situation inspired them with an idea that nuclear power plants do not differ significantly from the conventional power plants.

Detailed study of the accidents at nuclear power reactors in the USSR could have significantly increased the safety culture and prevent the Chernobyl accident. Already at the end of 1975 specialists could understand that the partial destruction of the core at the Unit 1 of the Leningrad NPP in October 1975 was caused by the positive reactivity surge [23]. The Chief Scientific Supervisor suggested a solution of this problem: operation of RBMKs with permanent presence of a quite high number of additional neutron absorbers in the lower part of the core and use of fuel with higher enrichment. This recommendation was implemented only after the Chernobyl accident.

The reasons of the accident that happened in October 1975 at the Leningrad NPP or at other Soviet NPPs was never discussed at scientific workshops and meetings. The similar power excursion because of positive steam-void coefficient occurred also at the Unit 1 of the Chernobyl NPP in September 1982 [23]. There were still similar situations at other RBMKs when the central fuel channel was destroyed [23]. However, practically nothing was made in order to eliminate even known shortages of the RBMK reactor.

Two reasons were responsible for this strange practice. The first was the hyper-secrecy even in the

field of the peaceful use of the nuclear energy. At second, such policy arose from the poor economics of RBMKs. According to [23], the constant use of a large number of additional absorbers in the core and the increase in the fuel enrichment were considered to decrease the competitiveness of this type of the nuclear reactor as much as it could not compete with any other sources of the energy. At the same time, the Soviet industry was not able to produce enough vessels for PWRs that could find a very bright use in other countries of the world. The USSR was practically forced to construct and operate such unsafe reactors as RBMKs.

The next complication arose from the fact that the Soviet specialists had not enough possibilities for detailed study of nuclear reactors in various situations. This was the reason why the designer of the RBMK was not able to receive a clear imagination about all features of it. All these circumstances resulted at the end in the Chernobyl accident, which caused immense losses for the USSR. This accident made also very negative influence on the development of the nuclear industry in the whole world.

The authorities of the former USSR tried to save the image of the Soviet nuclear industry and the political system of the country. In order to achieve this goal the Soviet specialists at the Post-Accident Review Meeting held on 25-29 August 1986 in Vienna, Austria [2] tried to put the responsibility for the accident on the operation staff of the 4th Unit of the Chernobyl NPP[3]. This attempt was totally inadequate because the operating staff as it was established later by the Sternberg commission [4] operated in frames of the existed regulations and instructions.

Conclusions

The main reasons of the accident at the Chernobyl NPP were sever shortages of the design, severe infringements of the safety regulations for construction of the reactor as well as low safety culture in the USSR preceding the accident. These factors were responsible for various errors of the operators that tried to carry out the electromechanical experiment at the time of shutdown of the Unit 4 of Chernobyl NPP. The reactor was brought by operators into unstable regime of operation in which a positive reactivity surge was introduced to the core. Possibly, the accident began from the boiling of water in some fuel channels in the lower part of the core because of a small temperature surplus. The pressing of the button AZ-5 by which all control and protection absorbing rods began to insert into the core increased the positive reactivity surge instead to decrease it. This caused fission chain reactions by prompt neutrons and uncontrolled excursion of the power. There is a high possibility that a number of explosions occurred in the core. One of these explosions was a nuclear explosion that destroyed the reactor of the Unit 4 of the Chernobyl NPP. The further studies are required in order to establish the real initiating factors of the Chernobyl accident and the real scenario of it.

References:

1. MinChernobyl. *Ten Years after the Accident at the Chernobyl NPP*. National Report of the Ukraine. Kiev.1996 (in Russian).
2. International Atomic Energy Agency. *Summary Report on the Post Review Meeting on the Chernobyl Accident*. Report by the International Nuclear Safety Advisory Group. Safety series N75-INSAG-1. IAEA, Vienna, 1986.
3. USSR State Committee on the Utilization of the Atomic Energy. *Accident at the Chernobyl-Nuclear-Power Plant and its Consequences. Information Compiled for the IAEA Expert's Meeting, 25 - 29 August 1986*. Part I. General Material. Draft. August 1986.
4. The State Committee for Atomic Safety Survey of the USSR. *On Reasons and Circumstances of the Accident in the 4 Unit of the Chernobyl NPP on April 26, 1986*.1991 (in Russian).
5. International Atomic Energy Agency. *The Chernobyl Accident: Supplement to INSAG-1*. Report by the International Consultative Group on the Nuclear Safety. Safety series N75-INSAG-7. IAEA, Vienna, 1993.
6. International Atomic Energy Agency. *Nuclear Power Reactors in the World. Reference Data Series No.2. April 1992*. IAEA, Vienna, 1992, p.38.

7. Dollezhal, N.A., Emeljanov I.Ya. *The Channel Nuclear Power Reactor*. Atomizdat. Moscow.1980 (in Russian).
8. USSR State Committee on the Utilization of the Atomic Energy. *Accident at the Chernobyl-Nuclear-Power Plant and its Consequences. Information Compiled for the IAEA Expert's Meeting, 25 – 29 August 1986*. Part II. Annexes 2,7. Draft. August 1986.
9. Adamov, E.O., Asmolov, V.G., Vasilevsky, V.P. *Raising the Safety of Atomic Power Station with Reactor RBMK*. Atomnaya Energiya. Moscow.1987, Vol.62. N4, April 1987, pp.219-226 (in Russian).
10. Chernousenko, V.M. Chernobyl. *Insight from the Inside*. Springer Verlag. Berlin, Heidelberg, New York, London, Paris, Tokyo, Hong Kong, Barselona, Budapest. 1991.
11. Medvedev, Grigorii.*Chernobyl Notebook*. Novyi Mir. Moscow.1989, N6 (in Russian).
12. Ukraine Minchernobyl. Academy of Sciences of Ukraine. *Description of the Ukrytiye Encasement and Requirements for its Conversion*. Kiev. Navukova Dumka.1992 (in Russian and English).
13. Kiselev, A.N., Checherov, K.P. *The Model of Destruction Process of the Unit 4 the Chernobyl Power Plant*. Atomnaya Energiya. Moscow. Vol.91. N6, December 2001, pp.425-434 (in Russian).
14. Adamov, E.O., Vasilevskji, V.P., Ionov, A.I. et al. *Analysis of the Accident Development First stage at the fours Unit of the Chernobyl Nuclear Power Plant*. Atomnaya Energiya. Moscow, 1980, Vol.64. N1, Januar 1988 (in Russian).
15. Pakhomov, S.A., Krivokhvatsty, K.S., Sokolov, I.A. *Assessment of the Prompt Energy Release by the Accident at the Reactor of th Chernobyl NPP Based on Estimation of the Ratio of Activities of Xenon-133 and Xenon-133m in the Air*. Radiokhimiya. Vol.33, N6, 1991, pp.125-132 (in Russian).
16. Martinez Val, Jose M., Aragones, Jose M., Mingués, Emilio, Perlado, Jose M., Velarade, Guillermio. *An Analysis of the Physical Causes of the Chernobyl Accident*. Nuclear Technology. Vol. 90, June 1990, pp.371 – 378.
17. *Chernobyl: Radioactive contamination of Natural Environments*. Edited by Yu.A.Izrael. Leningrad. Hydrometeoizdat. 1990, pp.141-142 (in Russian).
18. Arpott, D.G. and Green, C.D. *Chernobyl Unique Safety Valve for a Reactor Clear Explosion*. Proceedings of the British National conference “The Legacy of Nuclear-Lessons`for the UK” held at the Council House, Bristol, 11th March 1992.
19. Krayushkin, A.V., Kubarev, A.V., Tokarenko, V.E. et al. *Simulation of the Initial Phase of an Accident at the Chernobyl NPP 4th Power Unit*. In Proc. First Intern. Workshop on Past Severe Accidents and their Consequences. Moscow. Nauka, 1990.
20. Afanaseva, A., Burlakov, E., Krayushkin, A.V., Kubarev, A.V. *The Charackteristics of the RBMK Core*. Nucl. Techn..Vol.103, N1, 1993, pp.1-9.
21. *The succesful Experiment that ended with the catastrophe*. Tekhnika Molodezhi, Moscow. 1997, N9, pp.2-4 (in Russian)
22. Sivintsev, Yu.V. *Fission Numbers by the Accident at the Atomic Submarine in the Bay Chazhma*. Atomnaya Energiya. Moscow. Vol.89. N3, September 2000, p.256 (in Russian).
23. *Chernobyl Catastrophe; Reasons and Consequences (expert's conclusion). Part one. Direct Reasons of the Accident at the Chernobyl NPP. Dosimetrical Control. Protection Measures and their Efficiency*. Edited by V.B.Nesterenko and D.S.Firsova. SENMUR. TEST. Minsk. 1993, pp.48-49 (in Russian).

The Causes and Scenario of the Chernobyl Accident, and Radioactive Release on the CHNPP Unit-4 Site

Boris I. GORBACHEV

*National Academy of Sciences of Ukraine, The Interdisciplinary Scientific and Technical Center "Shelter"
36-a, Kirova st., 07270, Chernobyl, Ukraine: gorbachev26@mail.ru gorbachev@slavutich.kiev.ua*

Abstract

On the basis of analysis of old and new data, a realistic version regarding the causes of the Chernobyl accident was developed. In contrast to the previous official versions, this version gives a reasonable explanation to the accident process itself and the various circumstances around the moment of the accident that have not been properly explained up to now. According to this version, the personnel of the Unit-4 rushed to push the emergency shutdown button, AZ-5 after the first explosion occurred in the reactor core, and the seismic impact by the second explosion, which was more intensive than the first one, was registered at three seismic stations located 100 – 180 km from the CHNPP. Little-known experimental data regarding the nuclear fuel release around the 4-th Unit building are also presented.

1. Causes of Chernobyl accident: final choice between two versions

1.1. Two points of view

There are various explanations for the Chernobyl accident. Up to 2002 they can be counted more than 100 versions. However, from the point of view of reactor physics, only two versions can be deemed reasonable. The first one was reported in August 1986 [1], its essence being that at night on 26.04.86 the personnel of the CHNPP Unit-4 have outrageously violated the reactor safety regulations 6 times during the setting and executing process of the electrical test. The last violation was so outrageous that 204 control rods out of 211 regular ones (i.e. more than 96%) have been drawn out from the reactor core. The reactor safety regulations required meanwhile that "When the operational reactivity margin be reduced to 15 rods, the reactor should be shut down immediately" [2, p 52]. Moreover, the personnel have preliminarily switched off almost all of the emergency protection devices. While the reactor safety regulations stated that "11.1.8. Any interference in protection devices, automated protection mechanisms and blockage devices is forbidden, except for system malfunction cases [2, p 81]". These personnel actions have caused the reactor going out of control, followed by the uncontrolled chain reaction and finished with the thermal explosion of the reactor. In [1] "a careless reactor operation" has also been mentioned as well as the lack of understanding by the personnel about "the peculiarities of the reactor technological processes" and a loss of the "risk feeling" by the reactor personnel.

In addition, some specific features of the RBMK reactors have been pointed out that "helped" the personnel in bringing the serious nuclear accident to international catastrophe. In particular, "the reactor designers have not considered a possibility of such situation that the security system signals capable of preventing the accident would be intentionally disconnected from the technical protection system under the condition of the violations of the reactor safety regulations, only because they deemed such factor combination impossible". One can not object against the designers' opinion because the intentional disconnection and violations meant the "grave digging" that no-one is keen in. The final conclusion was stated as "the primary cause of the accident was the hardly possible combination of violations of safety and exploitation rules committed by the personnel of the Unit-4" [1].

In 1991 the second official governmental commission, organized by Governmental Committee for

Atomic Power Supervision (GCAPS) and composed of various NPP operators, has produced another explanation for the causes of the Chernobyl accident. The main idea provided by the second commission was that certain “construction defects” present in the Unit-4 reactor “helped” the reactor personnel to bring the reactor to explosion. The positive steam coefficient and the installation of long (until 1 m) graphite displacers of water at the end of the control rods are usually named as the main defects. The neutron absorption capability of the named displacers is lower than that of water. Therefore, their simultaneous insertion into the reactor core after the AZ-5 button pressing has displaced the water from technological channels. This, in turn, has added so much positive reactivity that the remaining “effective” 6-8 rods have no longer been capable to compensate it. Thus an uncontrolled chain reaction has started in the reactor, which has ended by the thermal explosion of the reactor.

After all, the pressing of the AZ-5 button is considered to be the starting accident event, having initiated the rods’ moving into the reactor core. Water displacement from the lower parts of technological channels has caused the increase of the neutron flux in the lower part of the reactor core. Local thermal loads in technological channels have exceeded the relevant mechanical strength limits. Breakage of several zirconium tubes of technological channels led to partial detachment of the reactor cover plate from the reactor casing. It caused multiple breakages of technological channels and the wreckage of the rods that were on their half-way to the lower position.

Consequently, scientists and the reactor designers were accused of the accident, as they created the reactor and the graphite displacers, while the personnel on duty had nothing to do with the causes of the accident.

In 1996 the third official governmental commission, also dominated by the former NPP operators, has confirmed the conclusions of the second commission after having analysed the cumulative materials.

1.2. Balance of standpoints

As the years passed, both parties have been keeping up their own standpoints. It is a curious point that the three official governmental commissions (all of the commissioners being highly experienced authorities) have reached absolutely opposite conclusions based on the same materials. There appears a general impression that suggests some kind of concealment in either the research materials or the commissions’ functioning. Especially, in the reports of these commissions, a series of key issues at the critical moment of the accident seem to be not described, or too simply described. Probably this is the reason why none of the parties could indubitably prove its case.

The ‘criminal relation’ between the reactor operators and its designers remained unclear, in particular, due to the fact that during the electrical test “only the operation factors important for the analysis of the test results were registered” [4]. The personnel is explained the situation as such. It is strange, however, that the personnel failed to register a series of main operation factors that were subject to automatic and continuous measurement (e.g. reactivity). “Therefore the accident development was reconstructed by mathematical simulations of the Unit 4, using the DREG printouts, the registered data and the interrogation of the reactor personnel” [4].

In this way, a long contradiction between scientists and operators has urged the need for an impartial study of all the accident-related data and materials accumulated during the last 15 years. This research should be on the leading principle of the Academy of Sciences, i.e. every statement needs convincing proof and every process needs natural and reasonable explanation. The most important results of such study are set forth herein.

1.3. The AZ-5 button pressing or doubts turning to suspicions

Scientists are commenting on the numerous documents produced by the governmental commissions (the Commission, afterwards) [1] that, if someone reviews the documents quickly, he has an impression of

a well-composed and consistent picture of the Chernobyl accident. A closer look, however, leaves a feeling of certain vagueness, as if there were either an incomplete investigation or withholdings of certain information by the Commission, e.g. concerning the AZ-5 button pressing episode.

“At 1 h 22 min 30 sec, the operator saw the program printout stating the operational reactivity margin has reached the limit requiring the immediate shut-down of the reactor. The personnel disregarded the data and the test was launched.

At 1 h 23 min 04 sec, the emergency stop valves (ESV) were closed at turbogenerator No 8...The available emergency protection system for ESV closing ...was blocked to assure the possibility to repeat the test in case the first attempt fails...

In a certain period of time the slow power rising was noted.

At 1 h 23 min 40 sec, the operators' chief ordered to press the emergency protection button AZ-5 that initiates the insertion of all the emergency protection control rods into the reactor core. The rods started moving down, but in a few seconds the blows were heard”[4].

The AZ-5 button is usually the last resort to be pressed in case there is an urgent emergency process within the reactor that can not be stopped by other means. In the quoted evidences, however, there was no reason for pressing the button, as there was no emergency process developing.

The testing period was initially fixed as 4 hours, and the quoted texts prove that the new attempt of repeating the test was planned by the shift personnel, which will take another 4 hours. During the test itself, i.e. on 36-th second of the experiment, however, the operators suddenly changed their opinion and started shutting down the reactor. One must have in mind that 70 seconds ago they refused the same procedure despite a highly risky situation and contrary to the requirements of the reactor safety regulations. All reporters have noted the groundless pressing of the AZ-5 button [5,6,9].

In addition, “The combined study of both the DREG printouts and teletypes indicates specifically that the 5-th category emergency signal ... AZ-5 appeared twice, the first one was recorded at 1 h 23 min 39 sec” [7]. But there are also additional data stating the AZ-5 button was pressed three times [8]. The question therefore is: why was the second and the third pressing needed, if the “rods started to move down” after the first pressing? Besides, when the testing was keeping up the initial plan, why should the shift personnel be so nervous? So, physicists started suspecting that at 1 h 23 min 39 sec or earlier some serious emergency did arise, which has made the shift personnel to change their plans, even at the cost of giving up the electric test program that could cause them serious administrative and other punishments. However, the issue was not subsequently reported by either the Commission or the shift operators.

This suspicion grew, as the scientists studying the causes of the Chernobyl accident have found out the asynchronous records within the original proving documents (DREG printouts and oscillograms). The suspicions grew even more when they found out they were given not the originals, but the copies thereof, “copies lacking the timing marks” [6]. That was a very likely attempt to mislead the scientists in respect of the real chronology of the emergency process development. And the scientists had nothing to do but say that “the most completed accident chronology is available...only until the test beginning at 1 h 23 min 04 sec 26.04.86” [6]. The subsequent “event information has essential gaps...and the accident chronology is highly contradictory” [6]. The above-cited scientific-diplomatic wording means practically the lack of credit to the copies presented for research.

1.4. Motion of the control rods

The majority of the afore-mentioned contradictions can be found in the information covering the issue of the control rods motion into the reactor core after the AZ-5 button pressing. One must bear in mind that after the AZ-5 button pressing all control rods had to be moved into the reactor core, 203 of them being from the upper limit stop switches. Consequently, by the moment of explosion they were to be

moved to the equal depth into the reactor core, which had to be registered with the selsyns pointers in the Unit-4 control room. The real picture is quite different. Some quotes below would be helpful:

“The rods started moving down...”[4]. No more records.

“01 h 23 min – strong blows, control rods stopped before having reached their lower limit stopswitches. Power supply key was switched off”. This is a quote from the operation log.[9].

“...approximately 20 rods kept staying in the upper position, while 14-15 rods were plunged into the reactor core not more than 1...2 m...”[16].

“...displacers of the emergency control rods have passed the distance of 1. 2 m and displaced completely the water columns thereunder...” [9].

“The neutrons absorbing rods started moving down and stopped almost immediately, their penetration to the reactor core being around 2-2.5 m instead of normal 7 m” [6].

“The investigation of the rods’ final positions under the selsyns pointers data showed approximately a half of rods stopped at a depth of 3.5 to 5.5 m” [12]. The question therefore is: where was the second half of the rods, provided all of them started moving down after the AZ-5 button was pressed?

“The positions of the selsyns pointers as conserved after the accident gives an assumption that... some of the rods reached the lower stop switches (the total of 17 rods, 12 of them being from the upper stop switches) [7].

The afore-stated quotes show various official documents describe differently the rods’ movement process. The oral evidence by the personnel indicates that the rods have moved into the core up to 3.5 m and stopped afterwards. The main proof of the rods’ motion into the reactor core is thus an oral evidence by the shift personnel and the selsyns pointers positions in Unit-4 control room. No other proof to the rods’ movement was discovered.

Should the pointers’ positions be documentary fixed during the accident, these data could serve the basis for reconstructing the accident. However, the afore-said pointers positions were fixed only during the daytime of April 26, 1986” [7], that is 12-15 hours after the accident. This fact can be deemed crucial, because the physicists working with selsyns are fully aware of their crafty properties. The first one is that the pointers of the selsyns-synchroreceivers can take any position in case the selsyns-synchrotransmitters undergo the uncontrolled mechanical impact,. The second property is that the absence of power supply to the selsyns causes the same effect to the selsyns-synchroreceivers pointers. Selsyns are not a mechanical watch fixing the specific moment of the air crash.

Therefore, defining the depth of the rods’ insertion into the reactor core at the moment of accident via fixing the selsyns-synchroreceivers pointers’ positions in Unit-4 control room 12 - 15 hours after the accident is highly inaccurate method, as the Unit-4 selsyns were exposed to both factors. This is disclosed in document [7], stating that 12 rods after the AZ-5 button pressing have passed the 7 m distance from the upper stop switches to the lower stop switches before the explosion happened. A logical question arises as to how the mentioned distance could be passed in 9 seconds while the normal timing to the same distance makes 18 to 21 seconds [4]. The data are obviously erroneous.

Therefore, the position of the pointers of selsyns-synchroreceivers in the Unit-4 control room as fixed 12 - 15 hours after the accident can not be deemed an objective scientific proof of the rods’ insertion into the reactor core after the AZ-5 button pressing. The proof remaining is only the subjective evidence of persons highly interested. The issue of the control rods motion into the reactor core after the AZ-5 button pressing is therefore still pending.

1.5. Seismic impact

In 1995 a new hypothesis has been spread in mass-media, stating that the Chernobyl accident was caused by a ‘narrow-beam like’ earthquake of 3 - 4 degree which took place near CHNPP approximately

16 – 22 sec before the Chernobyl accident, and this fact was confirmed by the relevant seismogram peaks [10]. The scientists, though, have rejected this version immediately as the unscientific and ill-proved. According to the seismologists' opinion on the issue, an earthquake of 3-4 degree with the epicenter in the north of Kiev region is nonsense.

But in 1997 a serious scientific report was published [21], containing the accurate data on the issue based on the analysis of seismograms obtained from 3 seismic stations located 100 – 180 km from the CHNPP. The data showed that at 01 h 23 min 39 sec (± 1 sec) local time “a weak seismic event” happened at the distance of 10 km to the east from CHNPP. The MPVA magnitude of the source defined based on the surface waves amplitudes was coordinated at all 3 seismic stations and was equal 2.5. Its TNT-equivalent was 10 t. It was impossible to estimate the source depth on the basis of the available data. In addition, the low amplitudes level on the seismograms and the one-way location of all seismic stations with regard to the epicenter gives the geographic coordinates error that can not to be less than 10 km. Therefore, this “week seismic event” could really happen at the CHNPP location [21].

These results made the scientists to reconsider more attentively the geotectonic hypothesis, because these seismic stations appeared to be the supersensitive ones that could register the underground nuclear tests all over the world. Therefore, the fact of an earthquake 10 – 16 sec before the official moment of the Chernobyl accident became an indisputable argument that no one could ignore.

The only strange circumstance with regard to these seismograms was the absence of peaks at the moment of the ‘official’ explosion of the Unit-4. We can say the following: the seismic devices registered a seismic event no one else could notice, while the Unit-4 explosion, which shook the earth and was felt by many persons, passed the attention of the seismic devices. One has to note that the devices in question are capable of detecting the explosion of some 100 t of TNT at a distance of 12 000 km, while the Unit-4 explosion was equal to 10 t of TNT and the distance was 100-180 km.

1.6. The new version

Numerous contradictions listed above as well as the lack of clarity in the materials in respect of various issues have strengthened the scientists' suspicions regarding the facts' concealment by the reactor operators. As the time passed, a revolutionary concept has been growing with the scientists – why could not the events happen vice versa? First – the double explosion, 500-meters high violet flames over the reactor, building of the Unit-4 shuddering all over, concrete beams shaking and steam-saturated air blast bursting into the Unit-4 control room. The general lightning went off, and only three accumulator-fed lamps kept functioning.

The personnel in the control room could not miss that. After having recovered from the first shock, the personnel rushed to press the AZ-5 button. But it was too late. The reactor was already destroyed. The whole story could take up to 10, 20 or 30 seconds after the explosion. Given that, the accident itself could have begun not at 01 h 23 min 40 sec, but earlier, and consequently, the uncontrolled chain reaction began before the AZ-5 button was pressed.

The suggested sequence of events gives a natural explanation for both the urgent multiple pressing of the AZ-5 button and the personnel' nervousness, which happened when they were going to exploit the reactor peacefully at least 4 hours more. This concept explains also the registered peak on the seismic curves at 01 h 23 min 39 sec and its absence at the ‘official’ moment of the accident. Finally, with this concept a natural explanation can be given to certain events that happened before the explosion and had previously no logical explanation, such as “vibrations”, “the increasing boom”, “hydroblows” from the central hall, “jumping” of 2000 “biological shield” blocks in the reactor central hall, etc [11].

1.7. Quantitative proofs

The naturalness of the explanations given to a series of unclear events by the afore-stated new

concept is a weighty argument in favor thereof. These arguments, however, have mostly of qualitative character, while our implacable opponents could be successfully persuaded only by the quantitative arguments. Therefore, the ‘rule of contraries’ (*reductio ad absurdum*) method will be used for demonstration.

Let us assume the reactor exploded “in some seconds” after pressing of the AZ-5 button and graphite displacers’ moving into reactor core. Such scheme presumes clearly that the Unit-4 was controlled by its personnel till the events started. That is, by the moment the AZ-5 button was pressed, the reactivity was somewhat near 0β . It is well known that the simultaneous moving of all control rods with graphite displacers into the reactor core can add positive reactivity from 0.2β to 2β dependent on the reactor state [5]. Should the sequence of events be the ‘official’ one, the total reactivity could at a certain moment surpass 1β value, which means the start of the explosive type uncontrolled chain reaction based on prompt neutrons.

Should that be the real accident scenario, the designers of the reactor would share the responsibility for the accident instead of the reactor operators. But should the reactor explode before the AZ-5 button was pressed or at the moment it was pressed, then the reactor reactivity at that moment was already more than 1β . In this case the fault for the accident falls apparently on the reactor personnel, as they lost control over the chain reaction after 01 h 22 min 30 sec when the reactor safety regulations required the reactor shut down. The question on the reactivity value at the moment of pressing of the AZ-5 button by the personnel has therefore has a fundamental importance.

The Unit-4 reactivity-meter readings could help to answer the above question. These readings, however, were not found among the accident-related documents. The question had been solved by various authors based on the computer simulation of the accident. The possible total reactivity values were obtained within the research process as lying between 4β to 10β [12]. In these works the total reactivity balance included mainly the effect of the control rods’ moving into reactor core (up to $+2 \beta$), the steam void effect (up to $+4 \beta$) and the loss-of-water void effect (up to $+4 \beta$). The impact of other processes (cavitation and others) was deemed secondary.

In all these works the accident process began with the AZ-5 button pressing followed by the moving of control rods into reactor core (adding another up to $+2 \beta$ to the total reactivity). That has caused the beginning of the uncontrolled chain reaction in the lower part of the reactor core, which has led to the breakage of the fuel channels. Then the steam and loss-of-water void effects came into action. They, in its turn, could bring the total reactivity up to $+10 \beta$ by the end of the reactor life. Our estimations of the total reactivity at the moment of the accident (based on the analog method using the American experimental data) [13], have shown a rather close value of $6-7 \beta$.

Now, assuming the most likely total reactivity value was 6β and deducting the highest possible $+2 \beta$ added by the graphite displacers, the final total reactivity value before moving the control rods into reactor core made $+4 \beta$. Such reactivity value is enough to cause the immediate destruction of the reactor. The reactor lifetime with such reactivity level makes no more than 0.01-0.02 sec. No personnel, whatever be their experience, could timely react to the appearing threat.

Hence, the quantitative estimations of reactivity before the accident also show the uncontrolled chain reaction began in the Unit-4 reactor before the AZ-5 button was pressed. Therefore, its pressing could not cause the reactor thermal explosion. Moreover, given the afore-stated circumstances, the specific time of AZ-5 button pressing (either before, or within, or after the reactor explosion) was already of no matter.

1.8. What are the witnesses saying?

During the investigation and tribunal the witnesses present in the Unit-4 control room during the accident were actually divided in two groups. The first one, composed of those who were liable by law for

the reactor safety, was stating that the reactor exploded after the AZ-5 button pressing. The second group, composed of those bearing no legal liability for the reactor safety, stated the reactor exploded either before or immediately after the AZ-5 button was pressed.

As everyone of them was trying to justify his actions when recalling the events, such evidences have to be treated with some caution. So did the author considering them as supplementary materials. The correctness of our version, however, can be seen even through this stream of justifications. Here is some quoting of the witnesses' evidences.

“The main engineer of the CHNPP second stage, who was in charge of the experiment... reported to me that he has pressed the AZ-5 button, as usually, to assure the reactor shut-down in case of any emergency...” [14].

This quotation is taken from the memories of B.V. Rogozkin who was the shiftman at the CHNPP during the night of the accident. It clearly shows that at first the emergency situation arose at the Unit-4 and then the operators pressed the AZ-5 button. In case of the reactor thermal explosion, the creation and running of the “emergency situation” occurs very fast within a second. Once it arose, the operators had no chance to react it.

“The whole event took 10 – 15 seconds. The vibrations appeared. The boom was growing quickly. The reactor power dropped at first and then started growing out of control. Then followed the several sudden claps and two “hydroblows”. The second one was much stronger and came from the central hall. Lightning went off in the control room, the ceiling plates started falling and the equipment went off as well” [15].

This is his description of the course of accident (no timing marks mentioned). Another such description was given by N. Popov.

“... a low-toned boom was heard, its source being absolutely unclear, similar to a human groan (the witnesses of the earthquakes and nature convulsions have been reporting similar sounds). The floor and walls shook strongly, dust and small crumbs started falling from the ceiling, lighting went off and then a dull sound came out, being followed with a thunderous burst ...”[17].

“I. Kirshenbaum, S. Gasin, U. Lisyuk, who were present in the Unit-4 control room witnessed they heard the order to shut down the reactor just either before or after the explosion” [16].

“At that moment I heard Akimov’s order to shut down the reactor. Then immediately the strong rumble came from the central hall.” (quote from A. Kuchar evidences) [16].

All these evidences show the moment of the reactor explosion and that of the AZ-5 button pressing almost coincided.

The impartial data also point this important circumstance out. Let us remember that the AZ-5 button was pressed at the first time at 01 h 23 min 39 sec and the second time – two seconds later (according to teletype data). Seismic curves showed the Unit-4 reactor explosion took place within the period of 01 h 23 min 38 sec to 01 h 23 min 40 sec [21]. Bearing in mind that the teletype time shift towards the standard USSR time could be ± 2 sec [21], one can firmly assume the moment of the reactor explosion and that of the AZ-5 button pressing almost coincided. This fact implacably denotes the uncontrolled chain reaction to have started in the Unit-4 reactor before the AZ-5 button was pressed.

But which explosion is now under consideration - the first or the second? The answer to this question can be found in the seismic curves and in the witnesses' evidences. Should the seismic stations have registered only one out of the two weak explosions, the natural assumption is that the stronger explosion was registered. According to the witnesses' evidence, the second explosion was the stronger one. It leads us to another firm assumption that the second explosion happened within the period of 01 h 23 min 38 sec to 01 h 23 min 40 sec.

The witnesses' evidences support this conclusion as follows.

“The reactor operator L. Toptunov shouted the reactor power had reached the emergency markup. Akimov shouted loudly: “Shut down the reactor!” and dashed to the control desk. There was the second ‘shut down’ order well heard by everyone. That happened apparently after the first explosion...” [16].

This evidence proves that the first explosion happened before the AZ-5 button was pressed for the second time. This is very important for our further analysis. An easy timing calculation would be of certain use. It is already known that the first AZ-5 button pressing took place at 01 h 23 min 39 sec and the second AZ-5 button pressing took place at 01 h 23 min 41 sec [12]. The time interval between both pressings makes 2 seconds. Viewing the emergency readings of the equipment, analyzing them and shouting “emergency power increase” would take no less than 4-5 seconds. Then one would need another 4-5 seconds to hear that, take the decision, order the reactor shut down, dash to the control desk and press the AZ-5 button. Thus, we have already 8-10 seconds ‘reserved’ before the AZ-5 button pressing. Remember now that by that moment the first explosion happened already. That is, it happened even earlier and definitely before the first AZ-5 button pressing.

How many seconds before the pressing? With regard to the inertness of the human reaction to an unexpected danger, which makes usually at least several seconds, we’ll need to add another 8-10 sec. So we obtain the total of 16 – 20 seconds ‘reserved’. Should the personnel act two times quicker, we still have 8-10 seconds ‘reserved’.

As the uncontrolled chain reaction finished with the thermal explosion, it had to have started 10 –15 sec earlier. We can therefore ultimately presume the uncontrolled chain reaction started within the period of 01 h 23 min 05 sec to 01 h 23 min 10 sec. Whatever surprising it may seem, the main witness pointed out, when answering the question regarding the adequacy or inadequacy of the AZ-5 button pressing at 01 h 23 min 40 sec (according to DREG), “I did not emphasize on the time – the explosion would have happened 36 seconds earlier...” [16]. That is, at 01 h 23 min 04 sec. As noted above, as early as 1986 the VNIAES specialists pointed out the same moment as the moment, after which the accident chronology (as reconstructed on the basis of the copies of accident-related documents presented for their study) was uncertain. There seems to be too many coincidences. What mean these coincidences? Apparently, the first accident features (“vibrations”, “unclear boom”, etc.) appeared already 36 seconds before the first AZ-5 button pressing.

The comparison of the accident materials and the witnesses’ evidences (as cited above) allows the conclusion that the first explosion happened within the period of 01 h 23 min 20 sec to 01 h 23 min 30 sec. It became the primary reason for the first AZ-5 button pressing. Remember now that no official commission or any author could give natural explanation to that.

But, why did the Unit-4 operators, being not beginners but an experienced team led by even more experienced the main engineer of the CHNPP second stage, nevertheless lose control over the chain reaction? Their memories answer to this question.

“We never intended to violate ORM and we did not violate it in fact. The violation is a willful disregarding of the devices’ readings, but on April 26th, 1986, nobody saw the ORM less 15 rods... But we evidently failed to notice that...” [16].

“One can never know why Akimov delayed his shut down order. We have been communicating each other, till we were put to different hospital rooms...” [16].

This declaration was written directly by the main participant of the accident events many years after the accident, when he was no more under the danger from either justice, or his former superiors. So he could write frankly. This declaration shows obviously to any reasonable man that the reactor explosion is definitely due to the fault of Unit-4 operators. Most likely the operators were so keen in the risky process of supporting the reactor power that has come to self-poisoning process due to their own fault, at the level of 200 MWt, and ‘failed to notice’ the inadmissibly dangerous rods removing out of the reactor core. And then the personnel “delayed” pressing the AZ-5 button.

That was the immediate technical cause of the Chernobyl accident. All the rest is misinformation (or, at best, just a huge mistake). The time has come to finish the heated discussion on who is in charge of the Chernobyl accident and shifting of the fault to scientists, as the reactor operators normally do. The scientists were right as early as 1986.

2. Accident scenario

2.1. The initial event

The new version permitted to prove the most natural scenario of the Chernobyl accident. By now it looks like as follows. At 00 h 28 min on April 26, 1986, while switching the reactor to the electric tests operation via switching from local automatic control (LAR) system to the power automatic control (AR) system, the operators made an error. Due to this error the reactor thermal power went down to 30 MWt while the reactor neutron power went down to zero and continued like that during 5 min according to the neutron power plotter [5]. The process of self-poisoning by short-life fission products started automatically in the reactor. The process itself contained no threat of nuclear explosion. Moreover, as this process develops, the reactor capability to support the chain reaction declines until the reactor fully stops irrespective to the operators' intentions. Throughout the world the reactor is being shut down in similar cases, and a 1-2 days' break is made till the reactor operation capabilities are restored. Then the reactor is switched in again. This is not an extraordinary process and does not present any difficulties for the experienced personnel of the Unit-4.

But this is a rather bothering and time-consuming procedure for RBMK-1000 reactors installed at CHNPP. In our case it also meant the wreckage of the electrical test plans that could cause various administrative troubles. So, being eager "to finish the testing as soon as possible", as it was later explained by the personnel, they began step-by-step removal of the control rods from the reactor core. Such removal was to compensate the reduction of the reactor power that happened as the result of the self-poisoning processes.

Such procedure was also usual for the Unit-4 reactor and could cause the nuclear accident only in case of excess removing of the control rods from the reactor core. When the quantity of the remained

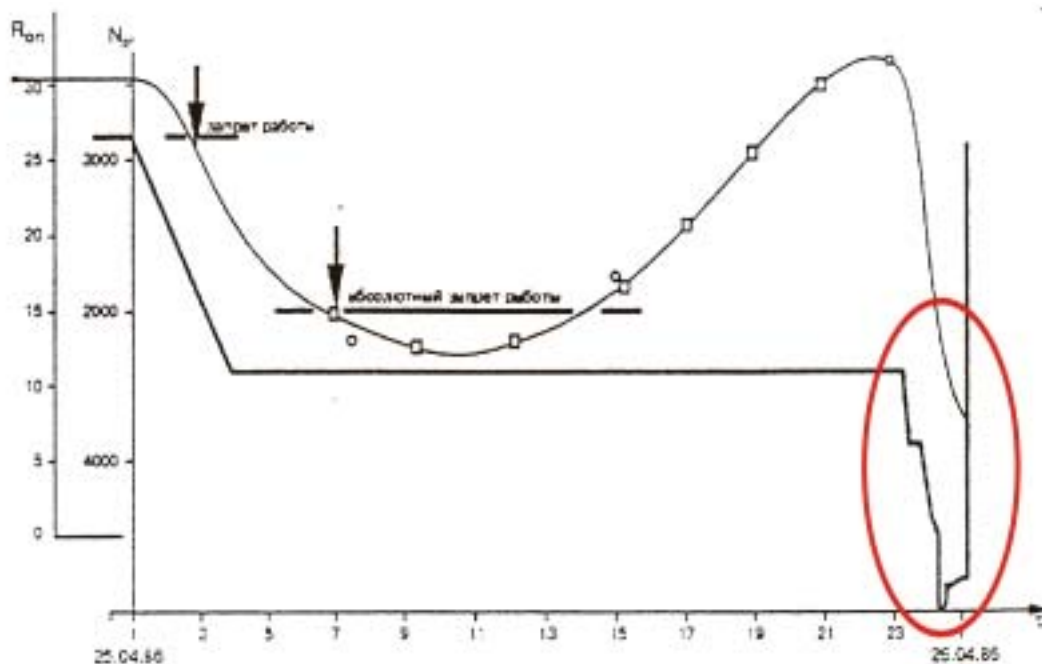

Fig. 1. The power (N_p) and the operational reactivity margin (R_{on}) of the Unit-4 reactor in diapason of the time from 25.04.1986 to the official moment of the accident 26.04.1986 [12]. The pre-accident and accident diapason of the time was marked by oval.

“effective” rods reached 15, the operators were to shut down the reactor, as it was their definite official duty.

By the way, similar violation happened for the first time at 07 h 10 min on April 25, 1986. That is, almost one day before the real accident, and this violation continued till 14 h 00 min (Fig, 1). It is interesting to note that within the course of this violation the operating shift teams and the shiftmen of the Unit-4 and of the whole CHNPP changed. Still, none of them gave any alarm, as if everything was under control, though the reactor was already on its breakpoint. The unwitting conclusion arises that the similar violations were common not only within the course of the 5-th shift of the Unit-4. This conclusion is supported by the evidence of I.I. Khazachkov, who was the day shiftman of the Unit-4 on April 25, 1986:

“We had many experiences of excessive removal of rods, I’d say – and nothing happened...”, “No one of us could envisage those actions could cause nuclear accidents. We knew these actions were prohibited, but we never thought...” [18].

The second time the violation took place on April 26, 1986, soon after midnight. But for some reasons the operators did not shut down the reactor and continued the rods’ removal. As a result at 01 h 22 min 30 sec the ORM reduced to “effective” 6 –8 rods. But this fact did not stop the personnel and they began the testing. Given that, we can definitely assume the operators continued the removal of the control rods till the explosion moment. This point is supported by the evidence that “the reactor power started growing slowly” [4] and the experimental curve of the timing markups of the reactor power changes [12] (Fig. 2).

No one throughout the world treats the reactor this way, as there are no technical means to assure the safe control over the self-poisoning reactor. The personnel of the Unit-4 evidently had no such means at their disposal. Definitely no one intended to make the reactor explode, so the excessive (more than standard “effective” 15) removal of the control rods was effected instinctively. From the point of view of a professional it was a pure venture. Why they did embark to it is a separate issue to be discussed.

Somewhere between 01 h 22 min 30 sec and 01 h 23 min 40 sec the intuition betrayed the operators and the number of “effective” rods remained in the reactor core appeared to be less than 6-8. Maybe 2 or 0. The reactor switched automatically to the support of the chain reaction based on prompt neutrons. There are no technical means to assure the reactor control within the similar regime, and such means are unlikely to be ever created. Therefore, during some fractions of seconds heat release in the reactor increased 1,500

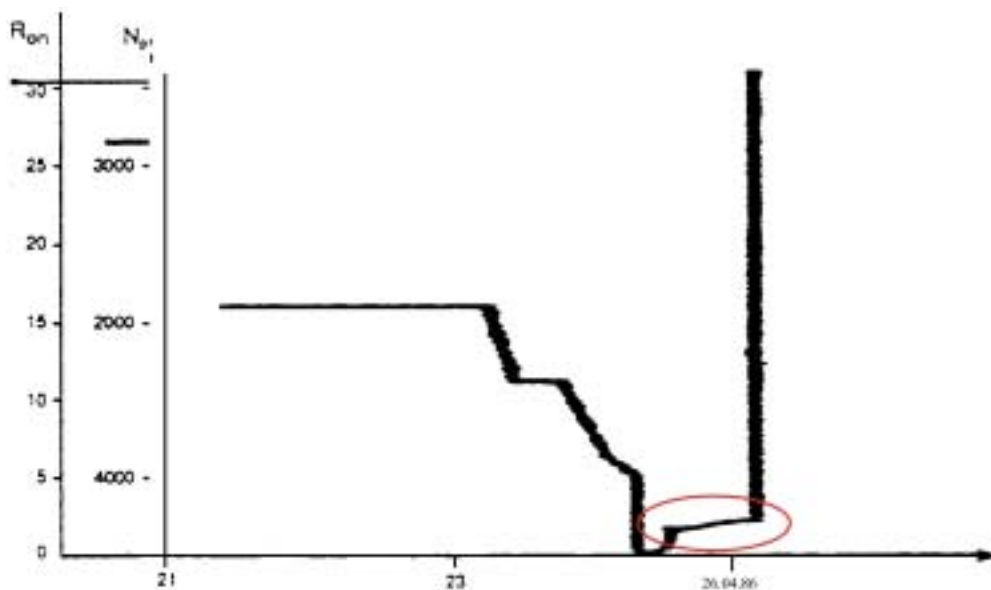

Fig.2. The change of the power (N_p) of the Unit-4 reactor in the diapason of the time from 23 h 00 min 25.04.1986 to the official moment of the accident 26.04.1986 .(The magnified part of the curve in Fig. 1). The unabated increasing of the reactor power calls attention.

times and nuclear fuel was heated up to 2,500 –3,000 °C [5,6]. Further the process named ‘the thermal explosion of the reactor’ began. The consequences thereof made CHNPP ‘famous’ throughout the world.

Therefore, the excessive rods’ removal from the reactor core should be considered more certainly as the event that initiated the uncontrolled chain reaction. The similar process happened in 1961 and in 1985 during other nuclear accidents that finished by the reactor thermal explosion. After the destruction of the fuel channels the reactivity increased due to both steam effect and void effect. To estimate the individual contribution of each of the stated factors to the final result, one needs a detailed computer simulation of the most intricate and at least the studied of the second phase of the accident.

The afore-stated scenario of the Chernobyl accident looks much stronger and seems to provide a far more natural explanation than the version based on the idea of moving the rods into the reactor core after pressing of the AZ-5 button. Because the quantitative effect data of this moving as given by different authors are scattering from rather serious 2β to negligibly small 0.2β , no one can say which of them has ‘worked’ during the accident. In addition, “as a result of studies by various teams of specialists....it was found out that one positive reactivity input via moving of RCPS-rods into the reactor core after AZ-5 button pressing, **was not enough**, provided all the feedbacks are taken into consideration, to reproduce the power peak, the start of which was recorded by the central control system CCS SKALA of the CHNPP Unit-4” [7] (Fig 1).

At the same time it has long been known that the control rods removal out the reactor core can add a bigger reactivity by itself – above 4β [13]. That is the first issue. The second one is that the rods’ insertion into the reactor core still has no scientific proof. The new version shows meanwhile that the rods could not be placed into the reactor core, because by the moment of pressing the AZ-5 button neither the rods, nor the reactor core existed. Thus the version stated by the personnel meets the qualitative arguments’ check but fails to meet in terms of quantitative arguments and, therefore, should be shelved from now on, while the scientists’ version has gained the additional quantitative support.

2.2. The “first explosion”

The uncontrolled chain reaction within the Unit-4 reactor began in a certain (rather small) part of the reactor and caused local overheating of cooling water. It is most likely to have started in the south-east quadrant of the reactor core at the height of 1.5 – 2.5 m above the OR-system. When the steam-water blend pressure exceeded the break point for the zirconium walls of the fuel channels, the channels were torn apart.

The extremely overheated water has turned into a high-pressure steam almost in a moment. The steam, while expanding, pushed up the heavy (2,500 t weight) E-system. The breakage of some of the fuel channels appeared to be enough to assure this effect. The initial phase of the reactor destruction was finished thereby and the second phase began.

While going up, the E-system was tearing the rest of the fuel channels like in the domino effect. Many tons of the overheated water have turned into steam almost in a moment, and the steam pressure pushed up the E-system up to the high of 10 – 14 m. The mixture of steam, graphite parts, nuclear fuel, parts of the broken fuel channels and other constructive elements of the reactor core rushed to the crater. The E-system itself, after swinging around in the air, fell back onto the crater having thereby crushed the top of a reactor core and causing the additional release of radioactive substances to the atmosphere. The double character of the “first explosion” can be explained by the blow caused when the E-system fell down.

2.3. The “second explosion”

In parallel to the afore-said mechanical processes various chemical reactions started in the reactor core. The exothermal steam-zirconium reaction is the most interesting one. It normally starts at 900°C and

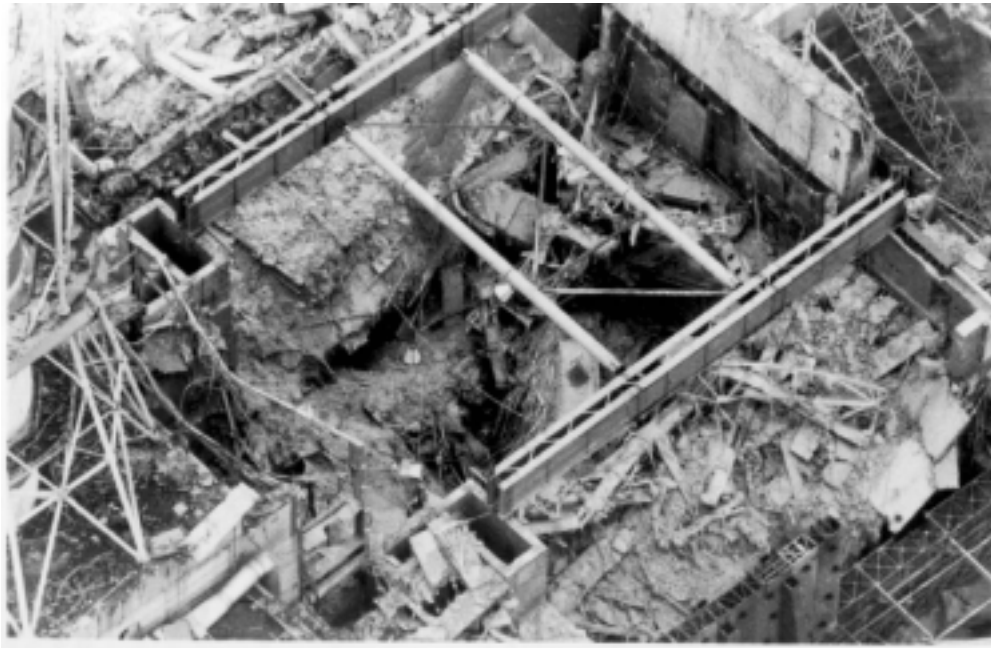

Photo 1. The destroyed Unit-4 reactor (top view).

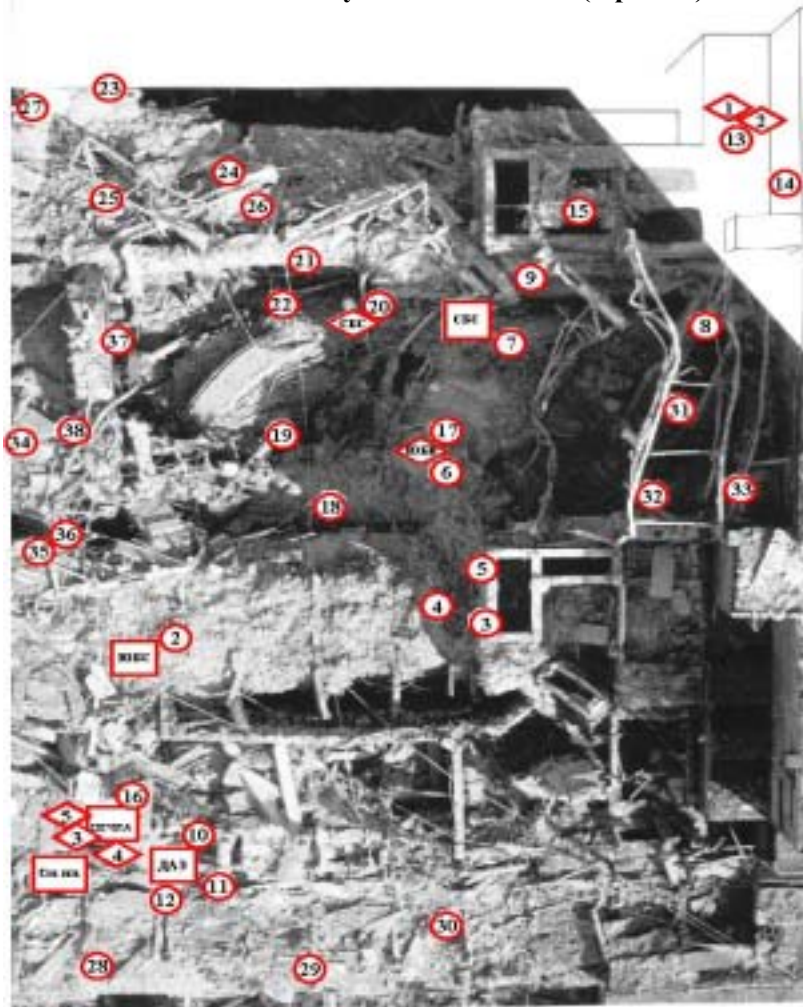

Photo 2. The view to the Central hall of the Unit-4 reactor(side view). The points of the fuel sampling for the following investigations were marked by circles.

proceeds intensively at already 1,100°C. Its possible role was studied in more detail in work [19]. This work showed that with regard to the conditions of the Unit-4 accident only this reaction itself could

generate more than 5,000 m³ of hydrogen.

When the E-system went into the air, the afore-said mass of hydrogen burst from the reactor into the central hall. While mixing with the air of the central hall, it created a detonation air-hydrogen blend. Then the blend exploded due to either a casual spangle or red-hot graphite pieces. According to the type of damages caused to the central hall, the explosion was rather massive - an analogy to a famous “vacuum bomb” explosion. It ruined the Unit-4 reactor building. Its outward results look rather impressive on the May 1986 photo. Two of them (Photos 1 and 2) are given as an example. Later the photos describing the explosion effect in under-reactor premises were obtained.

After both explosions the formation of the lava-like fuel-continued materials started in the under-reactor premises. But this unique phenomenon is the result of the accident and is worth a separate detailed consideration.

3. The fuel release to the Unit-4 site

3.1. First measurements of the radiation situation

After both explosions the nuclear fuel fragments, graphite fragments and radioactive constructions fragments were scattered around the reactor building. Main part of the release was concentrated in heaps near the walls of the Unit-4 building and on the roof of nearest building of the second stage of CHNPP. The radius of the reactor core fragments scattering reached 100 m. Some fragments were even found at a distance of 200 m. In addition to this release the fuel “hot particles” were falling on the Unit-4 site until 6 May 1986 (active stage of accident).

During the first days after the accident, exposure rate measurements were carried out by different means and improvised technical devices, via walking on foot or military transport with no accurate fixing of the measurements points coordinates (x,y,z) on maps.

Exposure rates on the Unit-4 site varied greatly – from tens of milli-Roentgen to thousands Roentgen per hour. Maximum value was reported near the destroyed Unit-4 and near the reactor core fragments.

As the measurements of the radiation situation were fulfilled under the conditions highly dangerous for the life of the investigators, they could not be systematic. The general radiation situation at the Unit-4 site by April 26, 1986, as reconstructed by the scientists of the “Khurchatov’s Institute”, Radium Institute and ISTC “Shelter” on the base of systematization and analysis of the first measured data, is shown in Fig

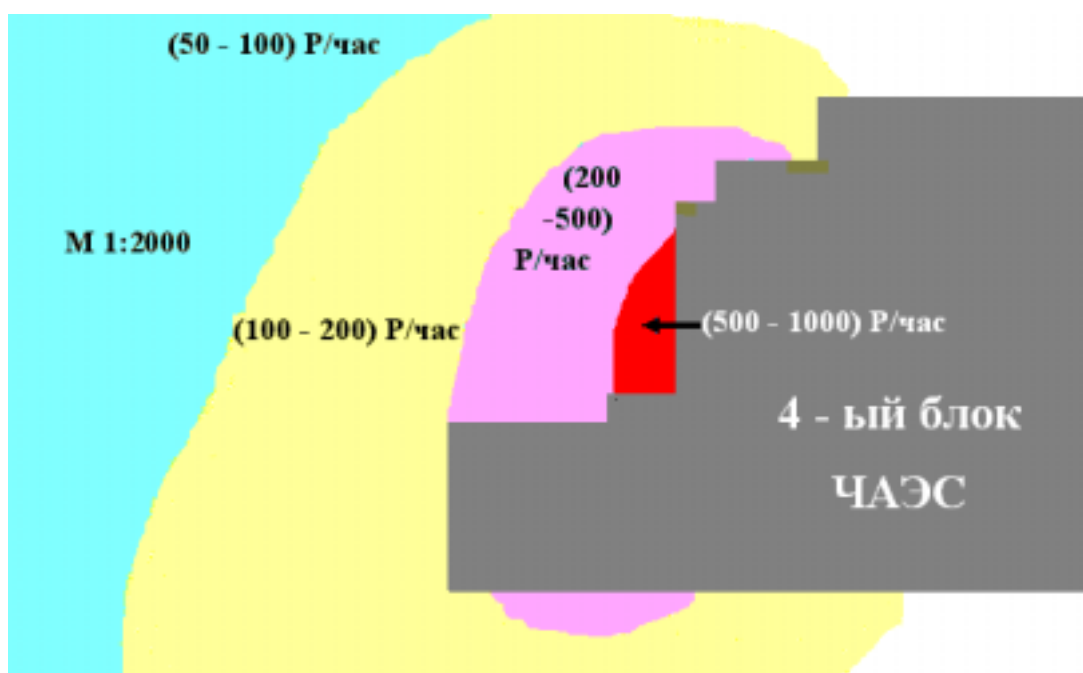

Fig. 3. The radiation situation on the CHNPP Unit-4 site at 26.04.1986 (P/час=R/hr).

3.2. Radiation measurements from helicopters

On May 22, 1986 the “Radium Institute” scientists began studying the gamma-field distribution around the Unit-4 site from helicopters type MI-8T. It flew over 12 routes along the CHNPP building with the 25 m interval from north to south and back. The site surface was scanned with the collimated detector with the NaI-crystal at the height of 200 m. The lead collimator assured the coverage area of the site surface at around ≈ 30 m in diameter. The initial calibration was fulfilled during the helicopter hang-up over the radioactive territory out of the Unit-4 site, where the concentration of the radionuclides and exposure rates were measured previously.

According to the “Radium Institute” estimations, the amount of the nuclear fuel released around the Unit-4 site (that remained at the moment of measurements) was 700 kg with the error $\pm 30\%$ [20].

Somewhat later (from 30 May 1986 to 09 June 1986) the joint team of “Khurchatov’s Institute” and of the Ministry of Geology started measuring from helicopters the radiation situation at the Unit 4 site and near the destroyed reactor. The measurements were taken over the reactor and near it using the measuring

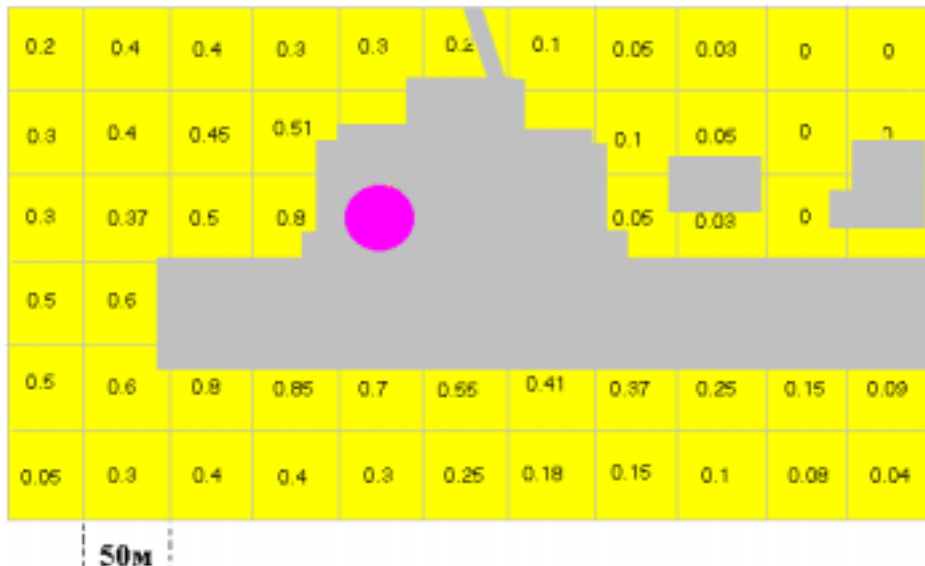

Fig 4. The nuclear fuel distribution, released to the Unit-4 site at the accident (relative unit).

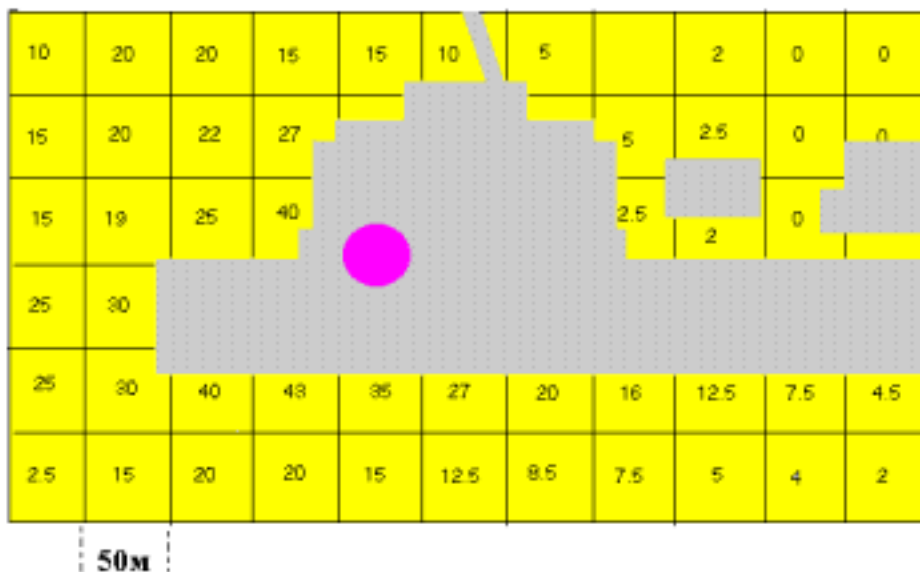

Fig. 5. The nuclear fuel distribution, released to the Unit-4 site at the accident (in kg on site 50×50 m²).

apparatus system placed at the helicopter type Ka-32CH. It allowed the surface scanning for the exposure dose at a height of 200 m and higher over the investigated surface.

Within the course of measurements the maps of the exposure rates at the reactor zone, the north and south drum-separators zone and at the other parts of the Unit-4 was obtained. Around 2,000 measurements were done on the surface sectors with the area of $10 \times 10 \text{ m}^2$ to $20 \times 20 \text{ m}^2$.

The chart of the relative gamma-fields distribution at the Unit-4 site is shown in Fig 4. The errors of these measurements are evidently much less than the errors of the absolute measurements. The results of this measurements permitted to estimate the total fuel amount at the Unit-4 site as $600 \pm 300 \text{ kg}$ [20].

The data obtained by both teams permitted, after certain analysis, to produce the most reliable chart of the fuel distribution at the Unit-4 site, averaged by $50 \times 50 \text{ m}^2$ sectors. For that purpose the quantitative data of the Radium Institute team were averaged and marked on the chart according to the relative measurements of the Khurchatov's Institute" team. Then the special program calculated the most probable correlation coefficient. As a result the full fuel amount at the Unit-4 site (outside the actual Unit-4 building) was estimated as 600 kg (-180, +300). The final estimations are shown in Fig. 5 [20].

The total error appeared to be rather serious. Therefore the investigators wanted to repeat the measurements work with more accuracy. But in some time the area of the Unit-4 site started being filled with different materials and then the concreting works started in order to cover the site surface. Therefore the repeated measurements appeared to be impossible. Still, the main result obtained during these measurements was that no more than 1 ton of the nuclear fuel kept staying around the Unit-4 site. The later measurements taken by boring the wells at the territory of the Unit-4 site supported this estimation, $600 \pm 200 \text{ kg}$ [20].

4. Some words on the adequacy of DREG printouts

One can object that the afore-stated new version of the Chernobyl accident contradicts the official chronology, based on the DREG printout as shown, for example, in [12]. The author does agree there is a contradiction, but a closer look into the stated printouts ultimately shows that the official chronology is not proved with the other accident-related documents starting at 01 h 23 min 40 sec and also contradicts completely both the reactor physics and the witnessed evidences. The VNIIAES specialists have paid attention to that as early as 1986 [4,5]. It was pointed out above already.

For example, the official chronology based on the DREG printout describes the accident process as follows:

- 01 h 23 min 39 sec (on teletape) - AZ-5 button pressing.
- 01 h 23 min 40 sec (on printout of DREG) - AZ-5 button pressing.
- 01 h 23 min 41 sec (on teletape) - AZ-5 button pressing.
- 01 h 23 min 43 sec (on printout of DREG) - An emergency increasing of the reactor power.
- 01 h 23 min 45 sec (on printout of DREG) - A reducing a amount of the pumped cooling water to $18\,000 \text{ m}^3/\text{h}$.
- 01 h 23 min 48 sec (on printout of DREG) - An increasing a amount of the pumped cooling water to $28\,000 \text{ m}^3/\text{h}$.
- 01 h 23 min 49 sec - A signal of the emergency protection "The pressure increasing in the reactor volume".

That is, according to the official chronology an emergency increasing of the reactor power began 3 seconds after of the AZ-5 button pressing (on DREG).

While, the witnesses evidences describe the accident process in the opposite order:

"...I was diverted to something. Maybe, it was the Toptunov's cry: "The reactor power increases

with an emergency speed!”. I am not sure in accuracy of this phrase, but the sense remember just such. Akimov dashed to the control desk quickly, opened the cover and pressed the AZ-5 button ...”. [22].

The main witness describes the same order of the accident events, which was shown above already [16].

According to the witnesses’ evidences, at first an emergency increasing of the reactor power began and then the AZ-5 button was pressed some seconds after it.

The official chronology contradicts to the reactor physics also. As directed above, a reactor life-time at a reactivity value 4β and above is a value of order 0.01-0.02 sec only. But, according to the DREG printout, 6 seconds was needed from the moment of an emergency increasing of the reactor power before the fuel channels began to break down only.

Nevertheless, for some reason absolutely, almost all of authors neglected this circumstance and assumed the DREG printout as a document, that adequately described the accident process. But it is wrong. The CHNPP personnel have known about it very long ago. The DREG program at CHNPP “was recognized as a background program, which was interrupted by all other functions” [22]. Consequently “... event time of DREG is not the true event time, but it is the time of signal recording about the event in a buffer (for a following tape recording)” [22]. By other words, the pointed events occurred, but at other, earlier times.

This very important circumstance was concealed from scientists 15 years. As a result of it, dozens of scientists worked during a lot of time in vine, investigating physical processes that led to such grand accident. They did their investigations based on the contradicted DREG printout and the evidences of witnesses who were liable by law for the reactor safety and therefore were strongly interested personally in an expansion of the version – “reactor exploded after the AZ-5 button pressing”. Meanwhile, for some reasons, they neglected the witnesses, bearing no legal liability for the reactor safety and therefore were more objective. And this most important recently opened circumstance confirms the conclusions of this work additionally.

5. The conclusions

1. The initial cause of the Chernobyl accident was the unprofessional actions of the 5-th shift personnel of the Unit-4. Most likely the operators were so keen in the risky process of supporting the reactor power, which has come to self-poisoning process due to their own fault at the level of 200 MWt, and ‘failed to notice’ the inadmissibly dangerous rods removing out of the reactor core. And then the personnel “delayed” pressing the AZ-5 button.
2. The motion of the graphite displacers into the reactor core could not be the cause of the Chernobyl accident, because at the moment of the first AZ-5 button pressing (01 h 23 min 39 sec) there did not exist the control rods and the reactor core already.
3. The reason for the first AZ-5 button pressing was the first explosion of the Unit-4 reactor, which happened in the period from 01 h 23 min 20 sec to 01 h 23 min 30 sec and destroyed the reactor core.
4. The second AZ-5 button pressing happened at 01 h 23 min 41 sec and essentially coincided with the second, more intensive explosion of air-hydrogen blend, which destroyed the Unit-4 reactor division building.
5. The official chronology of the Chernobyl accident, based on printout of DREG, describes the accident process inadequately after 01 h 23 min 40 sec. The VNIIAES specialists were the first men who paid an attention to it in 1986. It is necessary to start the official reconsideration of the accident chronology, taking into account the new circumstances, opened during the last years.

Literatures

1. Авария на Чернобыльской АЭС и её последствия: Информация ГК АЭ СССР, подготовленная для совещания в МАГАТЭ (Вена, 25-29 августа 1986 г.).
2. Типовой технологический регламент по эксплуатации блоков АЭС с ректором РБМК-1000. НИКИЭТ. Отчёт № 33/262982 от 28.09.1982 г.
3. О причинах и обстоятельствах аварии на 4 блоке ЧАЭС 26 апреля 1986 г. Доклад ГПАН СССР, Москва, 1991.
4. Информация об аварии на Чернобыльской АЭС и её последствиях, подготовленная для МАГАТЭ. Атомная Энергия, т. 61, вып. 5, ноябрь 1986.
5. Отчёт ИРЭП. Арх. № 1236 от 27.02.97.
6. Отчёт ИРЭП. Арх. № 1235 от 27.02.97.
7. Новосельский О.Ю., Подлазов Л.Н., Черкашов Ю.М Чернобыльская авария. Исходные данные для анализа. РНЦ «КИ», ВАНТ, сер. Физики ядерных реакторов, вып. 1, 1994.
8. Медведев Т. Чернобыльская тетрадь. Новый мир, № 6, 1989.
9. Доклад Правительственной комиссии «Причины и обстоятельства аварии 26 апреля 1986 г. на блоке 4 Чернобыльской АЭС. Действия по управлению аварией и ослаблению её последствий» (Обобщение выводов и результатов работ международных и отечественных учреждений и организаций) под рук. Смышляева А. Е. Держкоматомнагляд України. Рег. № 995Б1.
10. Например, «Новая газета», № 3 (105), октябрь 1995 г.
11. Хронология процесса развития последствий аварии на 4-м блоке ЧАЭС и действия персонала по их ликвидации. Отчёт ИЯИ АН УССР, 1990 и Свидетельства очевидцев. Приложение к отчёту.
12. См., например, А. А. Abagyan, E.O. Adamov, E.V.Burlakov et. al. “Chernobyl accident causes: overview of studies over the decade”, IAEA International conferens “One decade after Chernobyl: nuclear safety aspects”, Vienna, april 1-3, 1996, IAEA-J4-TC972, , p.46-65.
13. Мак-Каллех, Милле, Теллер. Безопасность ядерных реакторов//Мат-лы Междунар. конф. по мирному использованию атомной энергии, состоявшейся 8-20 августа 1955 г. Т.13. М.: Изд-во иностр. лит., 1958
14. Интервью Б.В. Рогожкина в газете «Киевские Ведомости», 14 мая 2001 г.
15. О. Гусев «У заграві чорнобильських блискавиць», т. 4, Київ, вид. “Варта”, 1998.
16. А.С. Дятлов. Чернобыль. Как это было. ООО Издательство «Научтехлитиздат», Москва. 2000.
17. Н. Никитин «Страницы Чернобыльской трагедии». Статья в газете «Вестник Чернобыля» № 21.
18. Ю. Щербак «Чернобыль», Москва, 1987.
19. Э.М. Пазухин «Взрыв водородно-воздушной смеси как возможная причина разрушения центрального зала 4-го блока Чернобыльской АЭС во время аварии 26 апреля 1986 г.», Радиохимия, т. 39, вып. 4, 1997.
20. «Анализ текущей безопасности объекта «Укрытие» и прогнозные оценки развития ситуации». Отчёт МНТЦ «Укрытие», рег. № 3836 от 25.12.2001. Под научным руководством доктора физ.-мат. наук А.А.Борового. Чернобыль.
21. В.Н.Страхов, В.И.Старостенко, О.М.Харитонов и др. «Сейсмические явления в районе Чернобыльской АЭС». Геофизический журнал, т. 19, № 3, 1997.
22. Карпан Н.В. Хронология аварии на 4-м блоке ЧАЭС. Аналитический отчёт, Д. № 17-2001, Киев, 2001.

Nuclear Fuel in the Destroyed 4th Unit of Chernobyl NPP

Volodymyr M. PAVLOVYCH

Institute for Nuclear Research of the National Academy of Science of Ukraine,

01028, Pr.Nauki, 47, Kyiv, Ukraine, e-mail: pavlovich@kinr.kiev.ua

Abstract

The main question, which determines the nuclear safety of the 4th destroyed unit of the Chernobyl NPP, as well as the question about the amount and distribution of nuclear fuel inside the "Sarcophagus" is discussed in the paper. The methods of determination of nuclear fuel quantity inside the "Sarcophagus" and the quantity thrown out of its boundaries are considered in detail. Special attention was paid to the quantity and distribution of the fuel in the under-reactor premise 305/2, which is looked as the most nuclear dangerous. On the base of such investigation and also taking into account the results of fuel containing material sample analysis, it is possible to make some calculation of the fuel containing material criticality and scenario of self-sustaining chain reaction development in the hypothetical situation of nuclear danger. Some of the results of such calculation are also presented in the paper.

1. The general description

One of the basic problems of the destroyed 4-th unit of Chernobyl NPP (somebody began to call it as "Shelter" or "Sarcophagus") which substantially defines the nuclear and radiation safety of the object, is the problem of nuclear fuel inside the Shelter. In order to estimate the nuclear and radiation safety of various premises of the Shelter, the knowledge is necessary about the nuclear fuel amount in each premise, the degrees of its primary enrichment and burnup at the moment of accident, the physical properties of the fuel containing materials (FCM), and opportunity of water incoming into each premise of the Shelter.

It is well known (see for example [1]) that at the moment of the accident there were approximately 214,600 kg of nuclear fuel in the fourth unit of ChNPP. The basic amount (190.2 ton) of this fuel was loaded into the reactor core, the part of the spent fuel was placed in the south cooling pond (14.8 ton), at the stand in the central hall (CH) there were the assemblies of fresh fuel (5.5 ton) prepared to loading to the core, and, at last, there was 4.1 ton of fresh nuclear fuel in a room of fresh fuel preparation.

At the moment of the accident, there were 1,659 fuel assemblies in the reactor core, and each assembly contained 0.1147 ton of uranium. The fresh fuel of the reactor RBMK-1000 before the accident at Chernobyl NPP contained 2 % of uranium-235. By the moment of the accident the majority of fuel assemblies were the first fueling assembly with fuel burnup from 11 up to 15 MWt-day/kg U. There were

Table 1. Burnup distribution of fuel assembly (FA).

Group	Number of FA	Average burnup MWt·day/kg U
1	721	13.7
2	392	12.3
3	154	10.5
4	101	8.8
5	35	7.0
6	43	5.4
7	41	3.5
8	172	1.2
FA total number	1659	
Average burnup		10.9

also fresh fuels in the reactor core. The distribution of fuel assemblies by the burnup level of 8-group approximation is given in Table 1.

A rough estimation shows that the burnup of 10 MWt-day/kg U approximately corresponds to a reduction of uranium-235 concentration by 1 % and an increase of plutonium-239 concentration (at the initial stage of campaign) by 0.4 %. Thus, if assuming an average burnup of 10.5 MWt-day/kg U, there were approximately 1,900 kg of uranium-235 and 760 kg of plutonium-239 in the reactor core at the moment of the accident.

Already in 1986 first estimations [2] have shown that as a result of the accident 3 - 5 % of nuclear fuel originally concentrated in the reactor core was thrown out of the 4-th unit boundary. The researches, which have been carried out during the subsequent 15 years, have confirmed these estimations as a whole. Now it is considered [1] that more then 96 % of fuel of the core + fuel in the pool of endurance + fresh fuel of the central hall remain inside the Shelter. 4.1 ton of fresh fuel was removed in 1986 from the fresh fuel preparation room after the accident.

In order to understand the physical properties of the fuel containing materials of the Shelter it is expedient to remind the basic stages of the accident scenario. As a result of reactor runaway with prompt neutrons there was a destruction of pin claddings, and the heated fuel has entered contact to the coolant (water). The explosive formation of water vapors has caused a sharp increase of pressure inside the reactor. This first explosion has resulted that the reactor cover (scheme "E", see Fig. 1 [1]) was thrown out in the central hall at the height about 14 m, and the reactor bottom plate (scheme "OP") was lowered approximately by 4 meter into the under-reactor premise 305/2, and the southeast quadrant of the scheme "OP" was completely destroyed. During the flight of the scheme "E" there was the second explosion which has destroyed the reactor building and particularly a drum-separator premise a part of wall of which has appeared inside the reactor vault. After that explosion the reactor cover was lowered in the position shown in Fig. 1.

As a result of the explosions a part of the fuel was thrown out of the limits of the reactor building, and the residual fuel in reactor began to be heated up due to heat release of fission products and burning of graphite. This process proceeded approximately within 10 days. During this time about 14 thousand tons of various materials: lead, dolomite, marble powder, sand, zeolite sorbent, and absorbers of neutrons containing boron were dropped from helicopters to the central hall and the reactor vault.

A part of these materials which has got into the reactor vault was melted together with fuel, pin claddings, walls of technological channel pipes, and material of the scheme "OP" backfilling (serpentinite). These melted materials have penetrated into the under-reactor rooms, whence then they have spread on

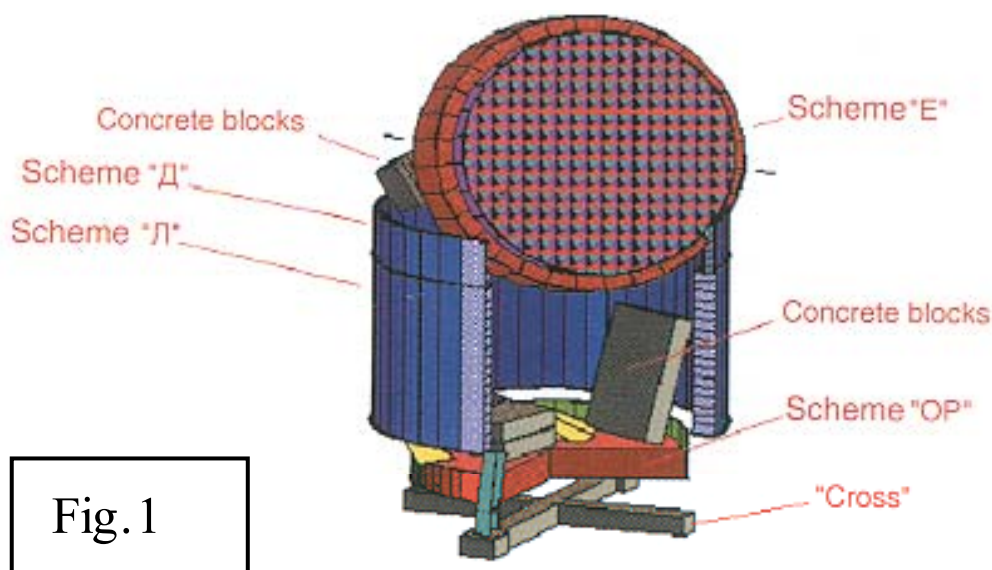

Fig. 1

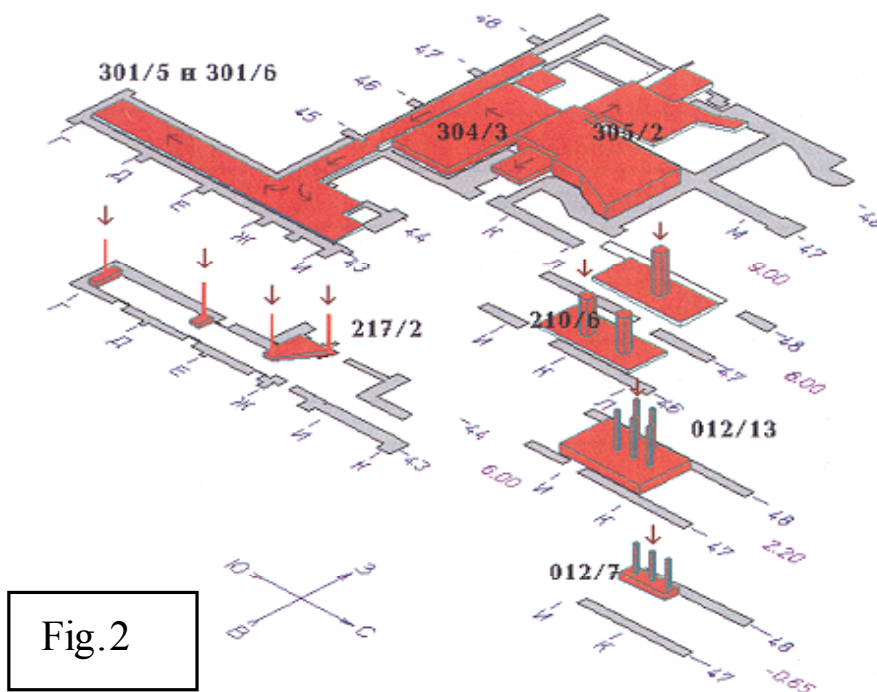

Fig. 2

numerous premises of the lower floors of the reactor building (Fig. 2 [1]). In these premises the solidified melt has formed so-called lava-like fuel containing masses (LFCM).

The lava-like FCM of the Shelter represent heterogeneous ceramics of brown or black color with inclusions of various natures. For example, only black ceramics is located in the premise 304/3, and there are both black and brown ceramics in the premise 305/2. The color of black ceramics is caused mainly by radiation defects, and after annealing it gets the bottle-green color which is the characteristics of silica-base glasses. The oxides of iron cause the color of brown ceramics, basically. The average content of different nuclides in ceramics of the premises 304/3 and 305/2 with exception of actinides is submitted in Table 2. A special attention should be given to the boron contents in LFCM. As it is known, boron is "a burning-out absorber", i.e. the quantity of an isotope B-10, which absorbs neutrons, decreases in the media with non-zero neutrons flux. In addition, boron is well-dissolved in water and can be washed away from the porous LFCM. We can not make the exact estimations of the amount of "burnt out" and moreover of the "washed up" boron. Therefore, it is necessary to make criticality calculations with content of boron taken from 10 years old LFCM sample analysis, and also without boron.

Table 2. Chemical composition of the FCM in premises 304/3 and 305/2 and concrete in wt. %.

Chemical element	Mixture		
	FCM, 304/3	FCM, 305/2	Concrete
B	0.06*	0.07*	-
O	43.4	37.1	55.26
Na	4.20	3.34	0.55
Mg	2.40	3.34	0.79
Al	4.80	2.90	2.90
Si	29.8	24.7	26.44
K	1.25	1.05	0.61
Ca	5.50	3.90	8.64
Fe	1.40	0.70	3.64
Zr	3.20	4.00	3.20
C	-	-	0.40
H	-	-	0.77

Let us consider now the LFCM macroscopic properties. According to the data of numerous investigations of samples taken from various under-reactor premises, the density of the LFCM changes over a wide range depending on porosity of the material. In this connection it is necessary to note that the LFCM are a strongly porous material with the sizes of pores and cavities of which change from microscopic dimensions up to the sizes about 1000 - 2000 cc. The LFCM are also a strongly non-uniform material whose density varies depending on the depth within the LFCM: for example, (0.9 - 1.8) g/cc in the premise 304/3 and (1.8 - 3.5) g/cc in 305/2.

At the present time the nuclear fuel in the Shelter is in several modifications. First of all, there are the kept fuel assemblies (the southern cooling pond and the central hall). The fragments of fuel pins and assemblies (core fragments) are found out also in various places. In some places of the under-reactor rooms, non-melted pellets of uranium dioxide were found out. In the LFCM, fuel exists as various inclusions in a silica-base matrix with the sizes from several up to 300 micrometers of various chemical structures [3]. Besides, uranium is also dissolved in a silicate matrix of the LFCM [4]. The concentration of uranium dissolved and included in the LFCM matrix changes from 4 % up to 10 % in various premises of the Shelter, and the mass portion of uranium-235 mainly corresponds to the burnup rate [5,6], though in some samples the portion of uranium-235 was much higher than the average [7,8].

Practically in each premise of the Shelter, the finely dispersed fuel particles (fuel dust) are observed with the sizes of particles from parts of micrometer up to hundreds of micrometers. This dust can represent the main radiation danger in conditions of hypothetical caving of the Shelter structures.

At last, it was revealed in 1990 that in water, which accumulates in some places of the bottom floors of the Shelter, salts of uranium, plutonium and americium are dissolved. The estimations show that up to 4,000 cubic meter of water per one year [7] can penetrate through the holes of the roofing of the Shelter and at the process of moisture condensation from the air. Percolating through fuel containing materials, this water dissolves some salts of uranium and transfers them to the bottom premises of the Shelter.

The nuclear safety of each premise of the Shelter is determined by the amount of fuel in this premise, the geometrical arrangement of this fuel, the opportunity of water ingress in this premise and its penetrations inside the fuel containing materials.

2. Estimation of fuel quantity in the Shelter premises and thrown out of its boundaries.

An estimation of the thrown out fuel quantity (3 ± 1.5) % offered in 1986 in the report of the Soviet delegation at IAEA meeting [2] has caused the large doubts. These doubts, which bound up basically with plentiful release of radioactive iodine-131 and caesium-137, were expressed as a rule by the nonprofessionals who did not take into account volatility of some components of the spent nuclear fuel.

It is possible basically to estimate the emission of nuclear fuel by three different ways [9]:

1. Measuring the quantity and the content of activity thrown out into the environment directly during the active stage of the accident;
2. Measuring the density of radionuclide pollution of the territory both directly adjacent to the Shelter and in the remote areas;
3. Determination of the fuel quantity in various premises of the Shelter. Then the knowledge of the total fuel load of reactor make it possible to estimate the quantity of the thrown out fuel by the difference.

It is natural that the most exact estimation of the thrown out fuel amount can be obtained combining all three methods.

The measurement of activity and contents of emission directly during the active stage of the accident was connected to the large methodical difficulties of aerosol sampling above the damaged reactor. These difficulties have resulted in the large enough errors (50 %) in determination of radioactive aerosol concentration in emission. Therefore, the first estimations of the thrown out activity were rather approached. Table 3 contains the results of researches published in work [2].

Table 3. Radioactivity ejection from the 4-th unit (in % to the activity accumulated in reactor to the moment of the accident).

Isotope	Ejection,%	Isotope	Ejection,%
¹³³ Xe	~100	¹⁴¹ Ce	2.3
^{85m} Kr	~100	¹⁴⁴ Ce	2.8
⁸⁵ Kr	~100	⁸⁹ Sr	4.0
¹³¹ I	20	⁹⁰ Sr	4.0
¹³² Te	15	²³⁹ Np	3.2
¹³⁴ Cs	10	²³⁸ Pu	3.0
¹³⁷ Cs	13	²³⁹ Pu	3.0
⁹⁹ Mo	2.3	²⁴⁰ Pu	3.0
⁹⁵ Zr	3.2	²⁴¹ Pu	3.0
¹⁰³ Ru	2.9	²⁴² Pu	3.0
¹⁰⁶ Ru	2.9	²⁴² Cm	3.0
¹⁴⁰ Ba	5.6		

The second way requires an estimation of the radioactive pollution of the large territories in the different countries and is very labour consuming. However, since the remote territories became polluted mainly by the volatile radionuclides (iodine, tellurium, caesium), and finely dispersed fuel particles containing heavy transuranium elements accumulated in the majority within the limits of a 30-kilometer zone around the Shelter, then it is possible to make an exact enough estimation of fuel emission by having carefully performed pollution investigations of the zone of alienation. In addition to this, undoubtedly, it is necessary to estimate a degree of reduction of the pollution by transuranium elements with increase of distance from a source of emission.

Such estimations were executed in 1986 by the group of researchers of Kurchatov Institute, and they were continuously became more precise during all 15 years past after the accident [10,11,12]. These estimations once again confirm a conclusion of work [1]: more than 95 % of fuel from the destroyed reactor core is concentrated in the Shelter.

3. The distribution of nuclear fuel on the Shelter rooms.

It seems that the third way of determination of the nuclear fuel amount which has been thrown out from the Shelter, i.e. the determination of the amount of fuel located in various premises of the Shelter, is exactest and accessible. However, a plenty enough of reasons exist obstructing to the detailed inspection of the Shelter. It is possible to attribute such handicaps to the followings: high radiation fields in the Shelter premises, the blockages of various materials dropped from helicopters to the central hall, the overflows of stiffened "fresh" concrete (1986) on the LFCM congestion and the large thickness of the LFCM layer in the premise 305/2, where the basic LFCM congestion is located.

The determination of the nuclear fuel quantity inside the Shelter and its distribution on premises is very important also from the point of view of nuclear safety of the Shelter and its radiation influence on the ChNPP personnel and the environment in the case of possible emergencies. Therefore below, we shall consider in detail the items of information about the distribution of nuclear fuel in the Shelter premises obtained up to the present time.

Let's begin from the central hall (CH) - one of the most complex places of the Shelter premises for an estimation of fuel quantity. Let's remind that in the CH before the accident, there were 5.5 ton of fresh fuel prepared for loading into the reactor core and 14.8 ton of the spent fuel in the southern cooling pond. The fuel pins are also in so-called "Helen hair" – the rests of technological channels which are hanging down from the scheme "E". Besides, in various places of the CH there can be fuel dispersed by the second explosion. It is possible only to use the indirect methods to estimate the quantity of the dispersed fuel, since the materials dropped from helicopters during the active stage of the accident cover the CH. The estimation of fuel quantity in "Helen hair" also can be carried out by indirect methods in connection with

high radiation fields in the CH.

Scientific groups from Khlopin Radium Institute and Kurchatov Institute carried out such estimations on the basis of measurement of radiation dose rate and localization of its sources in 1992. The estimations of such type can be only qualitative in connection with impossibility of exact localization of radiation sources. The results of calculations based on measurements of such type give that the quantity of fuel on the scheme "E" can be in limits from 10 up to 30 ton. There was found also up to 1 ton of fuel on the walls of the CH and other structures. Totally together with the spent fuel of cooling pond (the periscope inspection of which have shown the absence of water and the presence of all nondestroyed fuel assemblies) there can be from 31 up to 51 ton of fuel in the CH.

On the basis of video and periscope inspections of the reactor vault, it is possible to make a conclusion that there are no ordered structures of the former reactor in the shaft and now it is communicated with the under-reactor premise 305/2. Therefore, it is meaningful to estimate the quantity of fuel in the reactor shaft together with a premise 305/2.

Already in 1986 – 89, the first thermometric measurements of fuel quantity in the under-reactor premises were performed. These measurements were based on the fact that the integrated thermal flow outgoing from these premises completely should be determined by the thermal source power, and consequently by the complete mass of the fuel [13]. The specified estimations of 1990 [14] taking into account an error of measurements give for fuel mass in the premise 305/2 the value of 75 ± 25 ton.

It is possible also to estimate the fuel quantity in lavas of the under-reactor premises by balance of caesium and magnesium [3]. The last specified data [11,12] show that the complete emission of caesium-137 has made an activity about 2 MCi that forms about 28 % from the value of 7 MCi initially accumulated in the reactor core at the moment of the accident (compare with initial assessments of works [2], Table 3). This caesium took off only from the fuel, which has melted during the active stage of the accident and has formed the lava-like FCM.

On the other hand, the data of the numerous analyses show that no more than 40 % of caesium-137 remained in lava. It means that about 60 % of caesium-137 from its initial quantity in fuel, which has formed lava, has taken off, and these 60 % of caesium-137 have given the activity of 2 MCi. Therefore the initial activity of the caesium-137, which contained in the fuel forming a lava, is equal to $(2/0.6) = 3.3$ MCi. It makes $(3.3/7) = 47$ % from the amount originally accumulated in reactor, so 47 % of reactor fuel loading $(190.2 \times 0.47) = 89.39$ ton has come in a lava. Taking into account an error of estimations, we have 90 ± 27 ton.

The similar estimations can be made by the amount of magnesium whose average concentration in lava is equal to 3 % (compare with Table 2). The magnesium enters only into the structure of serpentinite, by which the scheme "OP" was filled up and its contents in serpentinite are 25.1 %. During the formation of lava, about 140 ton of serpentinite were melted [3]. Taking into account the percentage of magnesium in serpentinite and in the samples of a lava, it is possible to say that during the melting in the process of a lava dilution by other materials its weight has increased in $(25.1/3) = 8.5$ times and has reached approximately 1200 ton. The average content of uranium in lava samples is about 7 % [3]. Therefore the lower estimation of its weight in lava of the under-reactor premises makes about $(1200 \times 0.07) = 84$ ton. Taking into account the possible error, we have 80 ± 24 ton. All three estimations are in good coincidence among themselves.

It is necessary to note that at these estimations the presence of reactor core fragments is not taken into account, i.e. the fragments of pins and fuel assemblies and also non-melted fuel pellets which were observed in the under-reactor premises, and also can be under the melt in connection with their large densities. Therefore, and also with other reasons, it is necessary to consider the estimation of fuel quantity by the amount of caesium and magnesium to be underestimated.

Nevertheless, there was a work [15] in 1992 in which these estimations are put under doubt. The

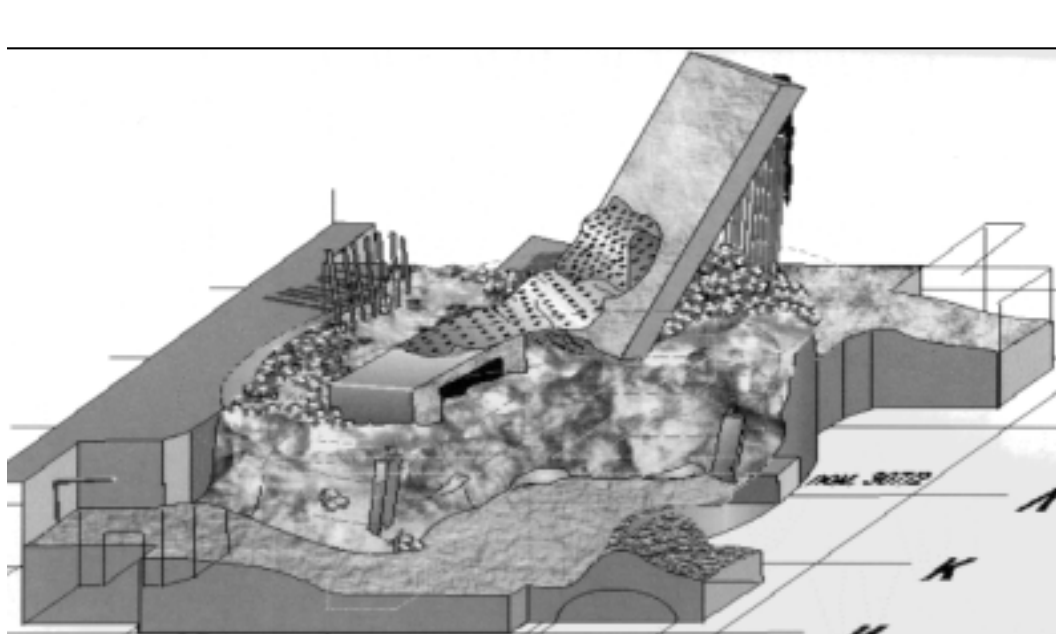

Fig.3 Computer model of the premise 305/2 and the reactor shaft.

authors of the paper [15] used for the estimations only the data of visual inspection and principle of communicated vessels. In their opinion, the under-reactor premises contain no more than 25 ± 5 ton of uranium.

This work was fairly criticized by many authors. However, it has served as a certain stimulus for new careful auditing of all data on the fuel quantity in the premise 305/2 [16]. For this auditing, the authors used the results of the analysis of more than hundred samples taken from the premise 305/2 in 1986-1997, the measurements of dose rate of γ - radiation, the results of all video- and photography of the premise 305/2 and the reactor shaft.

Then the whole space of the premise 305/2 was separated by the squares with a cross section 2×2 m. The estimation of the fuel quantity was performed in the LFCM volume over every square taking into account all data mentioned above. The square which data were absent or even partly was considered as empty that certainly underestimated the results. The computer model of the premise 305/2 and the reactor shaft was composed on the base of such detailed analysis of all materials which are located in this premise (Fig.3).

The precise consideration of all data concerning the premise 305/2 and the reactor shaft allows to make the following conclusion: there are not less than 60 ton of fuel in these premises. The LFCM passed from the premise 305/2 through the concrete wall destroyed by the explosion (or burns by the LFCM?) into the room 304/3 and then to steam distribution corridors (see Fig.2). The second flow of the heated lava passed through the steam outlet valves of different floors even to the first floor of the pool bubbler. The estimations of fuel quantity in all these premises raise no doubts. They are presented in Table 4 where the data of all measurements and estimations of fuel amount in the Shelter are summarized [1].

As we can see from this Table, the premise 305/2 and the central hall are the most “suspicious” from the point of view of nuclear safety. At the steam distribution corridors with marks 9 and 6 m, the lava layers are thin (the maximum value of 0.6 m in the premise 304/3), and in spite of sufficiently large fuel amount the probability of self sustaining chain reaction (SCR) ignition in these premises is negligible according to some evaluation.

In the southern cooling pond of the spent fuel where the water is absent at the present time the situation is safe until the pitch of the assembly suspension is conserved. The danger can arise only in the case of assembly caving to the bottom of the pond and its affluxion by water.

The water in the lowest premises of the Shelter has no nuclear danger at the present time. However,

Table 4. FCM distribution inside the Shelter.

Premises (mark)	FCM type and state	Estimated fuel in FCM (on uranium basis in metric tons)
- The central hall (35.50) - Other upper floor premises	- Core fragments (most of them are buried under materials dropped at the active stage of the accident. Under them LFCM can be found) - Fuel dust. - Fresh fuel assemblies - In the area of the scheme "E"	? 30? 5.5 10-30
- The south cooling pond (18.00-35.50)	- Fuel assemblies with the spent fuel	~14.8
- The under-reactor premises: 305/2 (9.00) + 307/2 + the "OR" system + the reactor vault	- Lava-like FCM, core fragments	75 (+25,-35) was proved to be >60 t.
- 304/3, 303/3, 301/5, 301/6, the "elephant's foot " and others	- LFCM	11±5
- Stream-distribution corridor (SDC) (6.00), including FCM in the valves.	- LFCM	25±11
- Pool bubbler, 2d floor (PB-2)	- LFCM	8±3
- Pool bubbler, 1st floor (PB-1)	- LFCM	1.5±0.7
- Lower premises of the reactor unit,	- Water with dissolved salts of uranium	~3000 m ³ of water <3 kg U

as far as the concentration of uranium salts will increase in the future the risk of the SCR ignition can also increase.

In order to estimate the nuclear safety of various premises of the Shelter two different ways exist. The first way is calculation of the neutron multiplication factor in these premises in different conditions including the most unfavorable condition of FCM water affluxion. The criticality calculation should be supplemented with calculation of SCR scenario development in the case if the criticality calculation shows a possibility of the multiplication factor exceeding of unity.

The second way consists in direct measurements of the neutron multiplication factor in the Shelter premises, and possible organization at this base of the continual monitoring of the FCM reactivity. The most expedient way is a creation of the mutual experimental and calculational method due to the absence of the full data to both precise criticality calculation and interpretation of experimental measurements.

4. The evaluation of the nuclear safety of different Shelter premises and possible scenario of SCR development.

The nuclear safety of the "Shelter", which is actually the question of criticality of the fuel-containing masses, has been considered by several groups of researchers [17-19]. Most of these calculations used the models whose properties are rather far from that of the real LFCM.

A model of the LFCM, closest to reality, was used in [18]. The LFCM in this paper were simulated by a multilayer system with variation of the LFCM density by layers in a rectangular geometry approximately corresponding to the layout of the rooms 304/3 and 305/2. The neutron reflection from concrete walls and floor was also taken into account. The nuclide composition of the LFCM and fuel concentration was chosen closest to the experimental data that were obtained during a study of the LFCM composition. The calculations show a deep subcriticality of both dry LFCM and LFCM filled by water. Nevertheless, the question of LFCM criticality remains open because in this work the existence of the core

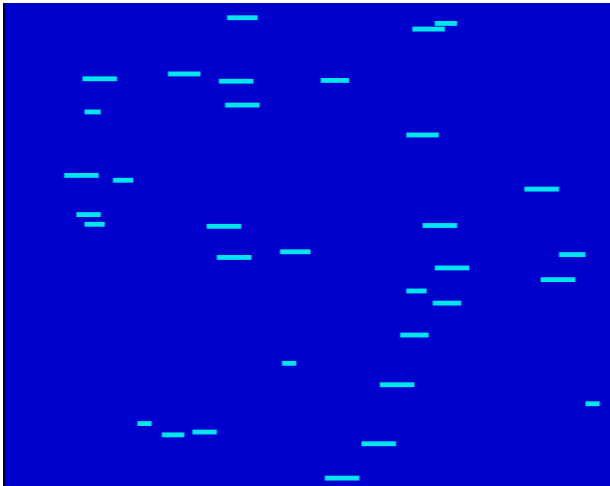

Fig. 4. Vertical cross section of rectangular parallelepiped of FCM with fuel pellets randomly distributed over its volume (model 1d).



Fig. 5. Vertical cross section of rectangular parallelepiped of FCM: three layer model of FCM, limited by a layer of concrete from below with nonmelted part of fuel in bottom sublayer as a cubic lattice of pellets (model 3b).

fragments in the premise 305/2 did not take into account.

What is it necessary to know for realization of criticality calculations?

1. Nuclide composition of the FCM and concrete, on which the FCM are located and also which covers the FCM in some places. This concrete can play a role of a reflector of neutrons.
2. Macroscopic properties of the FCM, such as density and porosity.
3. Geometrical parameters of the FCM – the size and shape of FCM accumulations.
4. Quantity and spatial distribution of fuel – this is the main question.

Nuclide composition of the FCM and concrete and also macroscopic properties of the FCM are known rather well from the results of the numerous analyses of the FCM samples. The geometrical parameters of the FCM in the under-reactor premises are known at the present time with sufficient accuracy due to investigation [16]. However, the question on quantity and spatial distribution of fuel in the FCM remains open in many details, especially in distribution of non-melted core fragment and fuel pellets, and for realization of real calculations it is required to involve the additional assumption about fuel distribution.

To determine the greatest possible value of the effective multiplication factor the various models of the FCM in the premise 305/2 were considered [20]. The schematic image of some of these models is given in Figures 4 and 5.

The enrichment of fuel was determined on the basis of the average fuel burnup of the order of 11.5 MWt·day/kgU [3]. As there was also the fresh fuel in the reactor before the accident, some models of the FCM were calculated with enrichment of fresh fuel. The total amount of fuel in the FCM was defined by both the average and the top values given by thermal measurements. The results of calculations are given at Figures 6-7 and in Table 5. All values were calculated depending on the contents of water in the FCM. In Figure 6, the neutron flux density spatial distribution is presented taking into account the presence of upper concrete reflector (ceiling). The analysis of such figures can help to determine the places of neutron detector installation in the FCM accumulations. In Figure 7, the neutron energy spectrum inside the FCM is given depending on a degree of FCM filling by water. In Table 5 the dependencies of the effective multiplication factor on a degree of FCM filling by water are given.

As it is evident from Table 5, the account of FCM heterogeneity not always results in increase of the effective multiplication factor. The effect depends on water concentration that is influencing on slowing-

down properties of the medium. The results of calculations show that the value of the effective multiplication factor weakly depends on the accepted model of an arrangement of non-melted inclusions, which allows to use for the majority of calculations the lattice models. For all models with the average amount of fuel (Model 3-5), the effective multiplication factor quickly increases from values 0.25-0.35 for dry FCM up to 0.65-0.70 at 20 % filling by water. At the further filling FCM by water, the effective multiplication factor decreases up to 0.60-0.65 for first two models of the FCM (Model 3, 4) and slowly increases up to value 0.8 for the last model of the FCM with non-melted inclusions in the bottom sublayer (Model 5). For infinite medium with a maximum quantity of fuel and the average burnup with a cubic lattice of pellets (Model 1f), the multiplication factor reaches 0.87 at 20 %-filling by water. The same model with fresh fuel (Model 1g) gives $k_{\infty} \approx 0.99$ at 20 %-filling by water, which is increased till 1.07 at 40 %-filling by water.

Thus, some models of fuel containing masses of the “Shelter” give the FCM multiplication factor exceeding unity. Our recent calculations show that there can be other models with the multiplication factor exceeding unity even with the spent fuel but with the bigger thickness of the layers. However, these values of the multiplication factor are reached only when enough quantity of water is contained in FCM volume. It means that during affluxion of the FCM by water from any external sources (rains, the condensation) the self-sustaining chain reaction of fuel nucleuses can arise inside the FCM.

The dynamics of ignition and development of SCR in FCM in various conditions of filling FCM by water and at various values of greatest possible reactivity, i.e. maximal effective multiplication factor, taking into account the Doppler-effect, is analyzed below. It is shown that, depending on the speed of FCM filling by water, the various modes of SCR development can be realized.

We shall assume that the heterogeneous composition with greatest possible effective multiplication factor exceeding unity is realized in the FCM (both the presence of such composition and an opportunity of its affluxion by water up to achievement of maximal reactivity are rather problematic), and we shall consider a qualitative picture of SCR development.

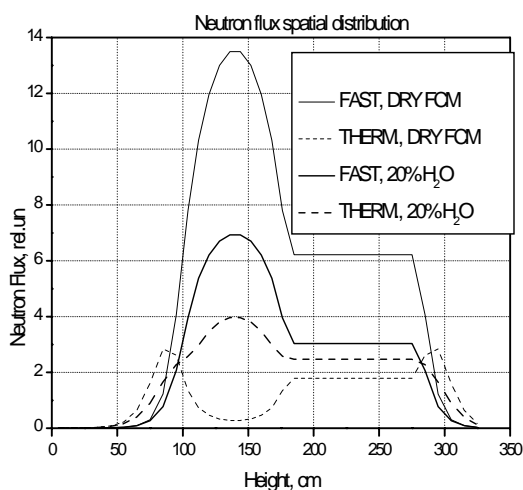

Fig. 6. A fast and thermal part of a neutron flux in a premise 305/2 in dependence on height for model 2a taking into account the presence of a concrete ceiling at height 1m from a FCM surface.

(0-100 cm – concrete, 100-180cm – FCM, 180-280 cm – air, >280cm – concrete)

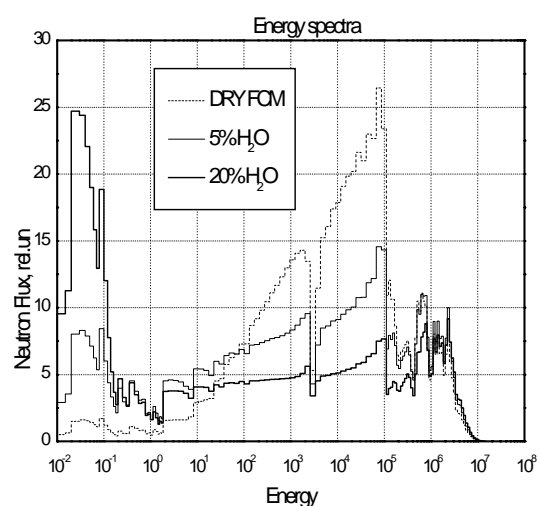

Fig. 7. A neutron energy spectrum in a premise 305/2.

Table 5. Results of the effective multiplication factor calculations for different models of the FCM in the room 305/2

Model of the FCM	Submodel	Effective multiplication factor		
		Dry FCM	FCM+ 20% H ₂ O	FCM+ 40% H ₂ O
1. Model of the FCM in the form of infinite medium	Completely homogenized fuel	0.26	0.76	0.70
	1a. cubic lattice of pellets in the uniform FCM	0.28	0.75	0.68
	1b. square lattice of pins in the uniform FCM	0.29	0.75	0.67
	1c. repeating cubes of the FCM, containing lattice of pellets	0.28	0.65	0.70
	1d. random distribution of pellets	0.28	0.65	0.70
	1e. cubic lattice of pellets in the uniform FCM – fresh fuel	0.32	0.81	0.73
1. Model of the FCM in the form of infinite medium (maximal quantity of the fuel)	Completely homogenized fuel	0.30	0.85	0.90
	1f. cubic lattice of pellets in the uniform FCM	0.32	0.87	0.96
	1g. cubic lattice of pellets in the uniform FCM –fresh fuel	0.40	0.99	1.073
2. Model of the FCM in the form of the uniform layer with vacuum boundary conditions	Completely homogenized fuel	0.11	0.64	0.64
	2a. cubic lattice of pellets in the uniform FCM	0.11	0.63	0.62
	2b. square lattice of pins in the uniform FCM	0.12	0.63	0.62
	2c. random distribution of pellets	0.11	0.63	0.61
3. Model of the FCM in the form of the uniform along height layer, located over the concrete layer	Completely homogenized fuel	0.25	0.66	0.65
	3a. cubic lattice of pellets in the uniform FCM	0.25	0.65	0.63
	3b. square lattice of pins in the uniform FCM	0.26	0.65	0.62
4. Three-layer model of the FCM with sublayer density dependence on the height, located over the concrete layer	Completely homogenized fuel of sublayers	0.25	0.66	0.66
	4b. cubic lattice of pellets in the uniform FCM of sublayers	0.26	0.65	0.63
	4c. square lattice of pins in the uniform FCM of sublayers	0.25	0.65	0.62
5. Three-layer model of the FCM, located over the concrete layer with nonmelted part of the fuel in the lower sublayer	Completely homogenized fuel of sublayers	0.32	0.73	0.78
	5b. cubic lattice of pellets in the uniform FCM of sublayers	0.33	0.67	0.76
	5c. square lattice of pins in the uniform FCM of sublayers	0.34	0.68	0.74

In order to analyze the FCM behavior in conditions of its reactivity changing due to filling FCM by water, it is necessary to solve the system of kinetic equations describing the situation. First of all, this is the equation of neutron transfer in the FCM medium, which should take into account the change in mean neutron lifetime due to the presence of delayed neutrons and dependence of reactivity on water quantity into the FCM and its temperature. The steady state calculations show that the dependence of reactivity on water quantity seems to be quadratic, which represents the moderating and absorbing properties of the water.

The second equation actually is the law of energy conservation, which takes into account fission energy release, the heating of the FCM, heat removing from the FCM surface and water evaporation. The third equation represents the law of water mass conservation, which takes into account the water incoming from the external source and its evaporation due to fission heating.

These equations in the frame of point model were investigated by qualitative stability methods and were solved by numerical methods [20]. The mentioned above different modes of SCR development depending on the parameter values were found. These modes are: the single neutron burst both in subcritical and overcritical regimes, the damped and stable neutron oscillations. The realization of one of

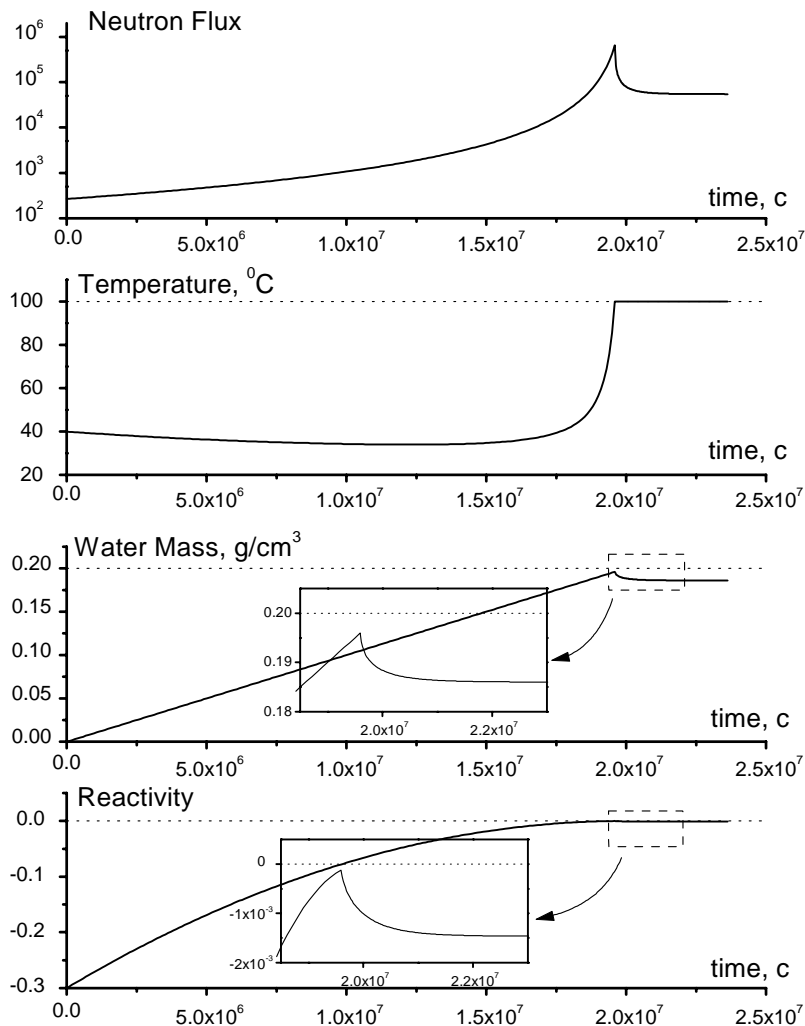

Fig. 8. Mode of an aperiodic subcritical burst.

these modes depends on the value of the neutron multiplication factor, on the velocity of FCM filling by the water, on the rate of heat removing etc. One of the most probable regimes of the subcritical neutron burst is presented in Fig. 8.

It is necessary to note that in 1990 and 1996 there were two neutron bursts registered by the neutron detectors located in the premises 304/3 and 305/2. There were a lot of discussions on the causes of these bursts, but it is evident that in both cases they occurred after the intensive rains in Chernobyl region. The pictures of burst development were very similar to that presented in Fig. 8.

5. The measurement of the FCM reactivity in the Shelter premises

Let us emphasize once more that the nuclear safety of the Shelter is defined first of all by the value of the neutron multiplication factor in the FCM of premises 305/2, 304/3, 210/6, the central hall, the reactor shaft and the southern cooling pond. Since the space distribution of the fuel in those places and the geometry of the FCM also are known inaccurately, the neutron calculation in those premises could be performed with the help of not very realistic models giving only not exact evaluations of the multiplication factor. In order to make the well-founded decision to increase the nuclear safety of the Shelter, those evaluations were inadequate. Therefore, a necessity arisen to measure the multiplication factor in those premises.

It is necessary to note that the attempts of such measurements in the Shelter were made in 1991 [21]. Those measurements were performed on the base of neutron pulse method, and authors have used the

standard geophysical equipment of neutron logging of the bores. They have no possibility to vary the frequency of neutron pulse emission, and they have small time of registration (2 ms) of the system response. Therefore, they could not detect the delayed neutrons and determine the multiplication factor with a sufficient precision.

One can conditionally divide the experimental methods of reactivity measurement on two classes: active and passive methods. The active methods assume some impact to multiplying system and subsequent measurement of the system response. One can realize the active methods both by the introduction into the system of the subsidiary reactivity (positive or negative) or with the influence by the external neutron source.

The methods connected with the introduction of additional reactivity are not suitable to measure the neutron multiplication factor in the FCM of the Shelter. This is, first of all, due to impossibility to estimate the value of injected reactivity even with known physical parameters of the injected materials. The cause of such situation is the same that leads to impossibility of exact calculation of the neutron multiplication factor. The pulse neutron method is the most widely distributed among the methods of external neutron source influence. But it is necessary to insert the pulse neutron source inside the FCM and to have a good electronic equipment in order to obtain the precise result. This method needs the boring of cavities inside the LFCM that is impossible at the present time.

Contrarily, the passive methods of reactivity determination are based on the measurement and analysis of the fluctuations of steady neutron background which is caused by the buildup of transuranium elements during the reactor operation or by the stationary external neutron source. By now in the FCM of the Shelter, the steady neutron background is determined by the spontaneous fission of some transuranics and (α, n)-reactions, and its fluctuations are due to statistical (probabilistic) nature of those processes.

By now there are several monitoring systems of the FCM neutron characteristics in operation at the Shelter («Finish», «Pilot», «KSFCM»). The current measurements of neutron flux density in the locations of neutron detectors are carried out with the help of these systems. The indications of neutron detectors are averaged over some intervals of time, considerably larger than the neutron lifetime. So there are measurements of the average on-time neutron flux density.

The indications of existing FCM monitoring systems can give the information only about the tendencies of neutron flux density changes, nothing speaking about the real value of such important characteristic of nuclear material accumulations as the effective multiplication factor k_{eff} . The knowledge of k_{eff} and keeping it at the certain level is one of the requirements of regulating bodies to organization maintaining, storing or supervising of the nuclear material accumulations.

It should be noted that the measurement of the neutron statistical characteristics can give much more information on nuclear material accumulation parameters than simple establishment of the tendency to reduction or growth of the neutron flux density. The methods of the analysis of the neutron flux density fluctuations and definition on their basis of the nuclear critical characteristics are conditionally divided into two parts: statistical discrete methods and methods of the neutron noise analysis. Both methods are basically possible to use for the subcriticality control of nuclear material congestion in the Shelter. The condition of modern electronics allows joining practically all methods in one experimental device executed on the basis of personal computer, which provides processing of the information according to algorithms determined by theoretical approaches. By now, such device is manufactured, and it is planned to use it in the near future to measure the effective multiplication factor in FCM of the Shelter.

6. Conclusion

As it is evident from the above that the Shelter at the present time is the nuclear dangerous object, it is necessary to make the significant efforts in order to define the degree of the danger and then to make the Shelter ecologically safe.

References

1. The Shelter Current Safety Analysis and Situation Development Forecasts (Updated Version). Tacis, 1998.
2. USSR State Committee on the Utilization of Atomic Energy - The Accident at the Chernobyl NPP and its Consequences, IAEA Post Accident Meeting, Vienna, 25-29 August, 1986.
3. Pazukhin E.M. Lavalike Fuel Containing Masses of the 4th Unit of the Chernobyl NPP: Topography, Physical and Chemical Properties, Scenario of Formation. Radiochemistry. 1994, v.36, No.2., p.97-142. (In Russian)
4. Zhidkov A.V. Fuel Containing Materials of the Shelter Today: Actual Physical Properties and the Possibility of Their State Forecasts. The Problems of Chernobyl. No.7, p.23-40, Chernobyl 2001.(In Russian)
5. Pazukhin E.M. The Burnup and Isotope Content of the Nuclear Fuel in the lava of the 4th Unit of Chernobyl NPP. Preprint of the ISTC "Shelter" No.00-8 Chernobyl 2001,12p. (In Russian)
6. Pazukhin E.M. Some Nuclear Physical Properties of the Fuel of the 4th Unit of Chernobyl NPP. The Problems of Chernobyl. No.7, p.149-158, Chernobyl 2001.(In Russian)
7. Bogatov S.A., Korneev A.A., Krinitsin A.P. et al. The problem of water in the Shelter Preprint of the ISTC "Shelter" No.99-5 Chernobyl 2001,27p. (In Russian).
8. Olkhovik Yu.A., Bondarenko G.N. Regional and Geochemical Evaluations of the radionuclide release of ChNPP including "Hot" Particles. In "Chernobyl Accident". Kiev, Naukova Dumka, 1995,p.203. (In Russian)
9. Borovoi A.A. Nuclear Fuel and Fission Products Release from reactor of the 4th Unit of ChNPP during the accident. The Problems of Chernobyl. No.7, p.130-140, Chernobyl 2001.(In Russian)
10. Borovoi A.A. Fission products and Transuranic Release during Chernobyl Accident. International Conference "The fission of Nuclei – 50 Years", Leningrad, 1989.
11. Sich A.R. The Chernobyl Accident Revisited, Part 3: Chernobyl Source Term Release Dynamics...// Nuclear Safety. – 1995. V.36, No2.
12. Devel I., Guntay S., Powers D.A. The Chernobyl Reactor Accident Source term. OCDE/GD(96)12.- Paris, 1996.
13. Grinchenko G.P., Ogorodnik S.S., Popov V.D. et al. Thermometric measurement at the Shelter. The Questions of the Atomic Science and Technology. Ser.Nuc.Phys.Res.1990, No.11(19), p.32-35.(In Russian)
14. Borovoi A.A., Ogorodnik S.S., Popov V.D. et al. The Evaluation of the Fuel Amount in the FCM Accumulation of Under-Reactor Premise: (Intermediate Report/ KE of Kurchatov Institute. № 11.07/26 – Chernobyl, 1990. (In Russian)
15. Kiselev A.N., Nenagliadov A.N., Surin A.I. et al. Experimental Study of the Lavalike Fuel Containing Masses (FCM) at the 4th Unit of ChNPP. M. 1992, 120 p. (Preprint of the Kurchatov IAE, №5533/3). (In Russian)
16. Borovoi A.A., Lagunencko A.S., Pazukhin E.M. Under-Apparatus Premise 305/2 of the 4th Unit of Chernobyl NPP: Its State, Fuel Quantity Evaluation. Chernobyl 1997, 12 p. (Preprint of the ISTC "Shelter" №97-7). (In Russian)
17. Nuclear and Radiation Safety during the Operations at the "Shelter": (Report)/ ISTC "Shelter" of the National Academy of Sciences of Ukraine.- Archive No. 3173 - Chornobyl, 1993. (In Russian)
18. The Elaboration of Suggestions and Recommendations on Monitoring and Diagnostics of Multiplying Properties of the LFCM of the "Shelter" of Chernobyl NPP: (Report)/ISTC "Shelter" of the National Academy of Sciences of Ukraine. Archive No. 3234 - Chernobyl, 1993. (In Russian)
19. The Technical Justification of Nuclear Safety of the "Shelter": (Report)/ I.I.Kurchatov Institute.-Moscow, 1990. (In Russian)
20. V. A. Babenko, L.L. Jenkovszky, V.N. Pavlovyh, et al, Fuel-Containing Masses of the Destroyed 4-th Unit of the Chernobyl NPP: Multiplying Properties and Neutron Characteristics. Nucl.Sc.&Eng. November 1999.
21. Lebedev G.V., Shikalov V.F. The Subcriticality Measurement of the Fuel Containing Masses of the Shelter. Moscow, 1995, 24 p. (Preprint of the Kurchatov IAE, No.5876/5)

Analysis of Radioactive Contamination in the Near Zone of Chernobyl NPP

Alexander GAYDAR and Oleg NASVIT*

Institute of Nuclear Research, NASU,

Prospekt Nauki, 47, Kyiv-28, 03680, Ukraine: gaydar@ukr.net

**Research Innovative Implementation Enterprise “Stroom”, Office “Stroom-Kyiv”*

28A, Artema St., Kyiv, 04053, Ukraine: nasvit@public.icyb.kiev.ua

Abstract

As a result of the Chernobyl accident a large amount of radionuclides have been turned out to the environment and spread over a large territory. The largest part of radioactive depositions is located on the territories adjacent to Chernobyl NPP.

The paper presents a brief review of the history and the current state of investigation of the Chernobyl accident deposition around the territories adjacent to Chernobyl NPP where a massive amount of reliable data have been accumulated about contamination levels and radionuclide compositions by using improved techniques for sampling and measurements. A geostatistical analysis of the obtained data provided a possibility to reveal the regional tendencies for levels and composition of the contamination, and to compile detailed maps of the contamination levels on the investigated territory for radionuclides such as ^{137}Cs , ^{90}Sr , ^{241}Am and plutonium isotopes. The contributions to the transuranium contamination due to Chernobyl were estimated by separating the contributions due to global depositions, and a prognostic map of ^{241}Am contamination was developed.

New geoinformation technologies elaborated by the authors are shown to provide a possibility to reveal the influence of landscape factors upon the contamination structure formation. An explanation of peculiarities of the shape and location of highly contaminated areas is proposed on the bases of landscape approach.

Introduction

Radioactive contamination of the environment in global scale was formed as a result of nuclear weapon tests in the atmosphere. The most part of residual radioactive products of nuclear explosions penetrated into the stratosphere (up to 40-50 km) and then slowly (during months and years) deposited on the earth surface and formed more or less uniform contamination with the maximum in the middle-attitudes of northern hemisphere [1]. As a result of the major accidents at nuclear and radioactive wastes processing and storage installations (Windscale, UK in 1957, the industrial complex “Mayak”, USSR in 1957 and 1967) the areas with high levels of radioactive contamination were formed [2].

On April 26, 1986, at about 1.24 a.m. two successive explosions that followed the reactor runaway at the Unit IV of Chernobyl NPP destroyed the reactor active zone and the unit building [3]. As a result of the accident various materials of the active zone (dispersed fuel, bits of fuel rods and graphite stack) were ejected from the reactor well and turned out into the environment. The initial release of radioactive materials to the atmosphere was so large and energetic that it resulted in penetrating of fission products to the atmospheric layer up to some kilometers [3, 4]. The exposed reactor core with burning graphite stack was a source of continued release of radioactive material to the atmosphere [4,5,6].

During ten days (April 26 – May 5, 1986) a large amount of radioactive materials released into the atmosphere (Fig. 1) were transported to a large distance in different directions depending on the change of wind directions [7, 8].

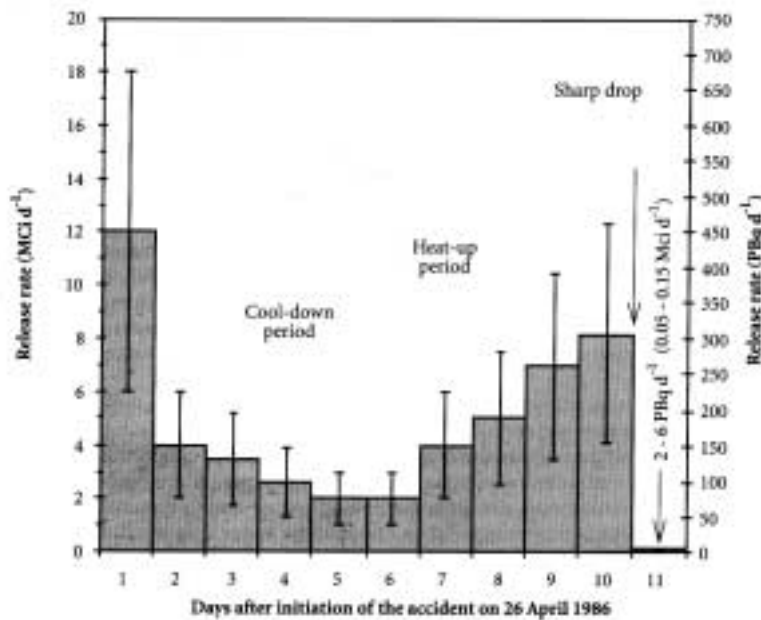

Fig. 1. Daily release rate of radioactive material into the atmosphere by the Chernobyl accident [1].

The highest levels of radionuclides deposition were formed on the territories of Ukraine and Belarus adjacent to Chernobyl NPP [7], while Chernobyl depositions were found in most of countries within the Europe [1]. With regard to its radioecological consequences the Chernobyl accident is recognized as the worst nuclear accident in the history of peaceful use of nuclear energy.

Radiation levels around Chernobyl NPP after the accident

From the first days after the accident extraordinary efforts to determine the contamination levels were undertaken to prevent the unwarrantable overirradiation of people. For the most contaminated area (up to 100 km around the Chernobyl NPP) the first map of radiation levels was made as early as May 1, 1986, [4] (at that time the formation of the Southern trace was being continued). By May 10, 1986, the map of exposure dose rates of gamma radiation was made. The first governmental decrees on people evacuation and other protective measures were decided on the basis of these maps.

However, the study of the detailed structure of contamination fields, comprehension of fallout characteristics and their time variation required significant efforts and could not be done right after the accident because of the large scale of contamination areas and specific features of the Chernobyl accident release.

Due to the lack of reliable objective data on the accident releases, contamination parameters and dose rate dynamics have been obtained by calculations which were based on the analysis of radionuclide depositions and the corresponding synoptic maps. These estimations have been corrected as new more detailed information has become available or new approaches have been developed.

On the basis of data on caesium isotopes deposition on the territory of the former Soviet Union the total release of ¹³⁷Cs has been estimated as $37 \cdot 10^{15}$ Bq or 13% of its activity in the reactor core [5]. Later an analysis of data on precipitation in the Northern Hemisphere resulted in correction of the corresponding values up to $70 - 85 \cdot 10^{15}$ Bq or near 33% [9]. This estimation is in a good agreement with the results obtained from the analysis of quantity and radionuclide composition of the fuel remaining in the “Shelter” object [6].

The release into the environment of significant quantity of radioactive iodine is considered as one of peculiarities of the Chernobyl accident. The radioiodine effect on thyroid is one of principal consequences of the Chernobyl accident. However, there is uncertainty in the assessments of the total release of

radioiodine from the Unit VI of Chernobyl NPP. The report [5] has given the value of $(0.62 \pm 0.3) \cdot 10^{18}$ Bq or 20% of activity in the core (re-calculation for May 6, 1986). Later a more pessimistic evaluation was made up to 50-60% [9]. On the basis of the investigation of ^{129}I content in the fuel remaining in the "Shelter" object [6] the value near 60% is considered as more reliable.

Comprehensive investigation of the distribution and specific features of the contamination around Chernobyl NPP provides necessary information for more correct assessments of absorbed radiation doses to population as well as for verification of hypothesis (models) of the processes and conditions in the destroyed reactor core.

History of investigation of spatial distribution of Chernobyl deposition

Among specific features of the Chernobyl accident contamination, it is necessary to note the following:

- extreme mosaic structure of contamination of large affected areas [1,4,7,10,11,12];
- complicated radionuclide composition of radioactive fallout [13,14,15];
- wide range of types and physical-chemical properties of radioactive precipitations [16,17];
- diversity of landscape and meteorological conditions, and their influence upon the processes of deposition, redistribution and migration of radionuclides in ecosystems [18].

A simple application of previous experience without taking into account above-mentioned specific features could lead and, unfortunately, did result in some slips, especially at the first post accident period. The radiological data with gridding to nearest settlements have permitted to estimate the average values of contamination levels for certain settlements but were unusable to provide information for the detailed investigations of spatial distribution of contamination. Due to the strong inhomogeneous distribution of hot particles the radiochemical determination of the content of certain radionuclides from different sample aliquots led to significant errors in radionuclides composition determination.

It should be mentioned also that in the former Soviet Union practically all investigations connected with nuclear energy and industry were unreasonably secret and centralized. By this reason a significant part of radioecological data for the first days and months after the disaster were accumulated in the secret departments of central offices and have been practically lost.

The most detailed information on the contamination structure has been obtained with airborne-gamma-spectrum survey (AGS). Such investigations were carried out from the very first days after the accident. But, due to complicated character of gamma-spectra, the first reliable and detailed maps of ^{137}Cs contamination were obtained only by 1988-89 [4]. Unfortunately, these results are available (in Ukraine) only on paper.

At present, there are some regular digital sets of ^{137}Cs contamination levels for the territories adjacent to Chernobyl NPP. One of the first digital maps of ^{137}Cs contamination was compiled on the basis of data obtained with the AGS survey carried out by the Institute of Radiology UAAS and STC "Prypiat" in 1992-1993 [19]. This map covered, however, only the 30-km zone and the scale of mapping was not sufficient enough for detailed analysis of the contamination structure.

During the ensuing years enterprise "Pivnichukrgeologiya" carried out AGS for the adjacent territories to Chernobyl NPP as well as for the most contaminated part of Ukraine. The map compiled on the basis of these data [20] provided more detailed information on the contamination structure, but later investigations found certain discrepancy in a number of cases about the ^{137}Cs contamination level between AGS and measurements of soil samples [21].

At present ^{137}Cs dominates the radioecological situation on the major part of the contaminated territories in Ukraine. For the territories adjacent to ChNPP, however, the study of spatial distribution and properties of ^{90}Sr and transuraniums contamination will remain the task of great importance for a long

time.

In 1987-88 for the purpose of detailed and systematic investigation of contamination properties and their dynamics, a special observation network was established on the territories adjacent to ChNPP [4,7]. By this network the sampling and determination of contamination levels have been performed for wide range of radionuclides including ^{241}Am , ^{144}Ce , ^{137}Cs , ^{90}Sr and $^{238,239+240}\text{Pu}$. On the basis of obtained data the corresponding maps have been made as well as necessary evaluations of the radioecological situation. But, the very inhomogeneous spatial distribution of contamination and the formalism of establishing of the network (nomination of observation points) didn't permit to obtain the detailed information about spatial distribution of contamination (especially at the periphery and outside of the 30-km zone). For example, the "narrow west trace", which was most contaminated by fuel component, appeared to be situated between two sets of observation points and was practically lost under the map compiling [7].

Modern approach to investigation of spatial distribution of Chernobyl deposition

In order to obtain more detailed information about the contamination structure a group of scientists of the Institute for Nuclear Research of NASU (KINR) has been carrying out sampling and measurements since 1992 based on a more regular network established in the frame of national programs. Using improved techniques investigation is being carried out on the spatial distribution and the radionuclide composition of radioactive contamination on the territories adjacent to Chernobyl NPP [21,22,23] as well as on the remote regions of Ukraine.

The latest developments in Geographical Information Systems (GIS) for compiling of contamination maps provides a possibility to formulate the basic protocols of the new approach, which include requirements for data analysis as well as for soil sampling and radionuclides measurements, as follows:

- sampling location is selected after analysing the existing data and the information about the contamination structure of the territory being considered;
- sampling plot within the selected location is determined on the basis of careful radiological inspection of the location so as to provide the most representative position;
- exact gridding of sampling plots by using GPS and topographic maps of the corresponding scale;
- determination of sampling depth on the basis of preliminary study of the ^{137}Cs depth profiles;
- sampling of not less than 5 soil cores for each sampling plot;
- using of the same sample for measurements of all radionuclides;
- careful verification of the obtained data and establishing of the most reliable values for the location;
- geostatistical analysis of the obtained data (spatial distribution of the absolute values as well as regional peculiarities of the radionuclides ratios);
- determination of the regional regularities and invariants of the spatial distributions of radionuclides (including their ratios);
- taking into account landscape features of the locations and territory;
- selection of the most appropriate methods for map compiling according to the established regularities.

By now the data on the contamination levels were obtained for more than 1,500 locations on the territories adjacent to Chernobyl NPP. For example, a map indicating sample location (the Voronoi-Thiessen polygons) is shown in Fig. 2, together with ^{137}Cs contamination levels obtained by AGS survey. The density and the shapes of polygons characterize the quality of new observation (the center of each polygon coincides with the sampling points). For each sampling location the levels of contamination by long-lived radionuclides, including ^{137}Cs , ^{90}Sr , $^{238,239+240}\text{Pu}$, ^{241}Am have been determined.

Due to high gradient of contamination levels on the investigated territory the representativeness of the observed locations takes on special significance. The exact locating of sampling plots has permitted to make a precise comparison of the data obtained for locations (soil samples) with the average data for the

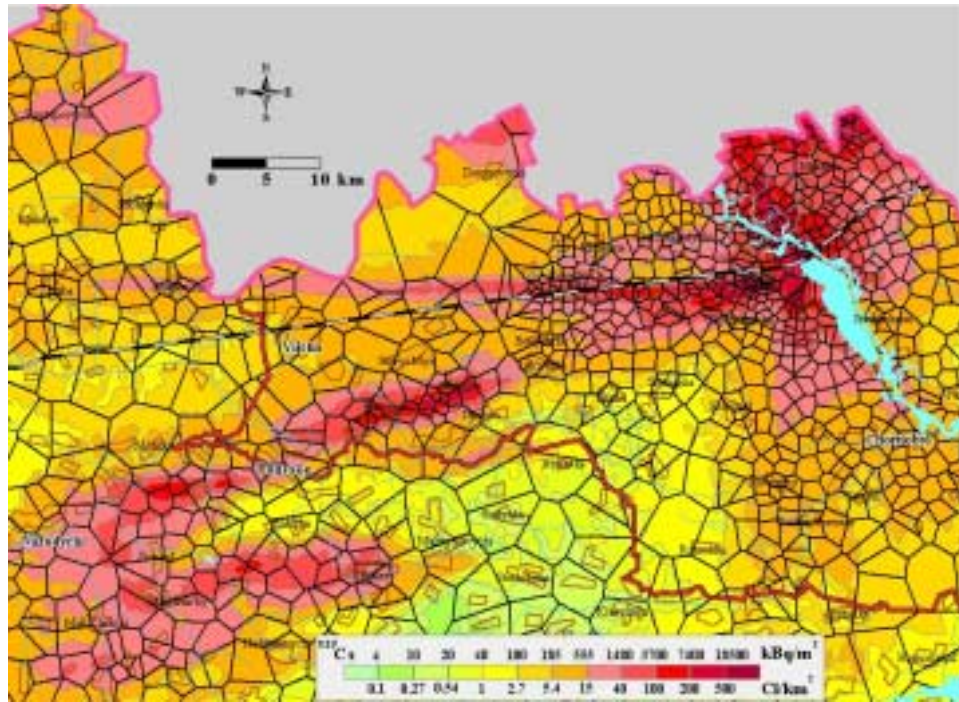

Fig. 2. Map of the locations studied on the adjacent territory to Chernobyl NPP (Ukrainian part) overlapping the AGS: ^{137}Cs contamination.

nearest grid points of AGS (Fig. 3).

Grouping of data points near the bisecting line testifies a high level of the agreement for data obtained by different techniques and the representativeness of the observed plots. As a result of spatial analysis for the corresponding data, it has been established that at locations with high levels of contamination the data of AGS must be slightly corrected accordingly to the data of soil samples measurements. The improved map compiled by new approaches about ^{137}Cs contamination on the adjacent territory to Chernobyl NPP is shown in Fig. 4.

The used techniques of sampling and measurements permitted to carry out comprehensive analysis of regional tendencies for the values of ratios between different radionuclides. For example, the trends of the

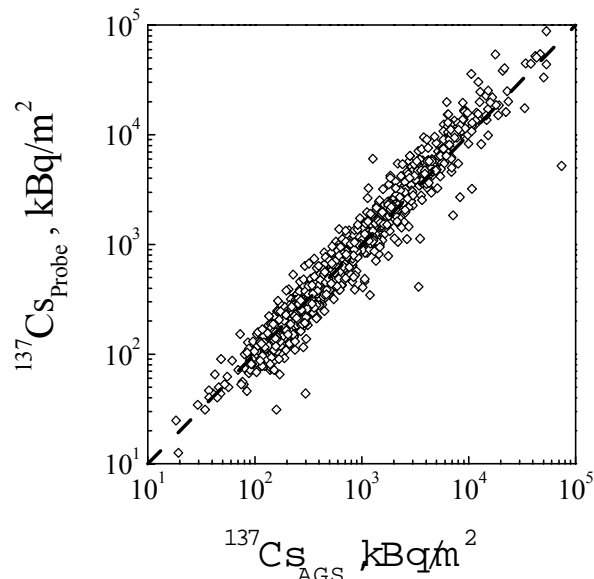

Fig. 3. The regression of data obtained by the probe sampling measurements and by AGS.

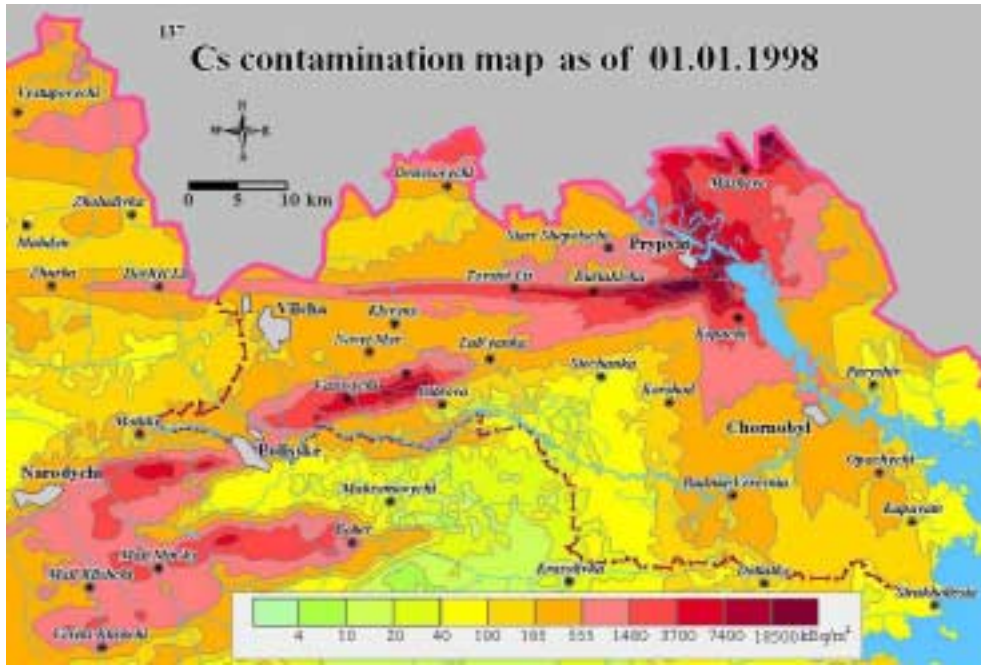

Fig. 4. ^{137}Cs contamination map of the adjacent territory to Chernobyl NPP (Ukrainian part).

$^{137}\text{Cs}/^{239+240}\text{Pu}$ values for the various radioactive traces are presented in Fig. 5.

As it can be seen in Fig. 5, the ratio of $^{137}\text{Cs}/^{239+240}\text{Pu}$ for all directions is practically constant up to 10 km (for the south trace up to 30 km), and similar to that of the Unit IV fuel. As the distance increases, the regional peculiarities become apparent. For example, for the north trace the ratio begins increasing at about 10 km and exceeds 350 at distance 20 km, while for the western trace the corresponding values remain less than 300 up to 100 km.

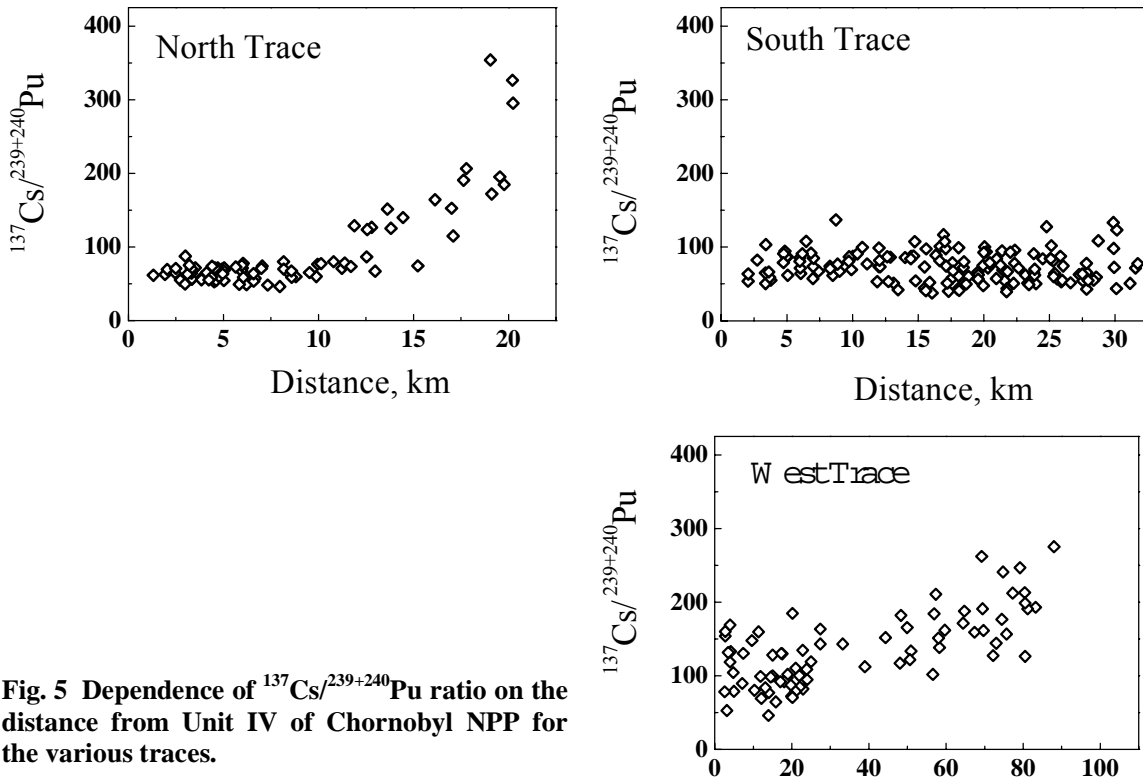

Fig. 5 Dependence of $^{137}\text{Cs}/^{239+240}\text{Pu}$ ratio on the distance from Unit IV of Chernobyl NPP for the various traces.

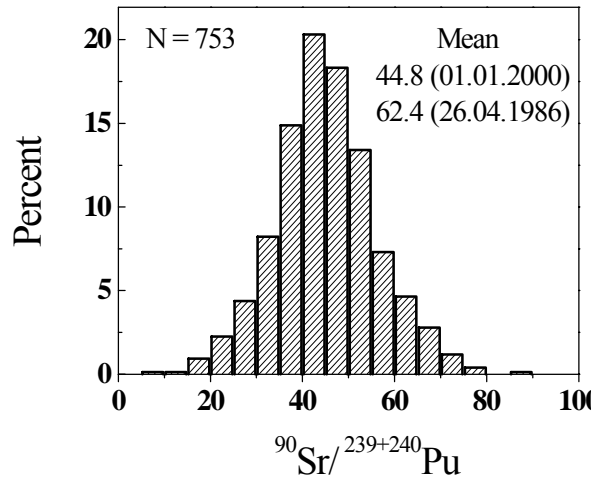

Fig. 6. Frequency distribution of $^{90}\text{Sr}/^{239+240}\text{Pu}$ ratio in soil samples within the 30-km zone of Chernobyl NPP.

A more stable behavior within the 30 km zone of Chernobyl NPP is observed for $^{90}\text{Sr}/^{239+240}\text{Pu}$ ratio. Fig. 6 presents the frequency distribution of it within the territory being considered.

Taking into account the steady character of $^{90}\text{Sr}/^{239+240}\text{Pu}$ ratio, it was proposed to use a constant $^{90}\text{Sr}/^{239+240}\text{Pu}$ ratio, by combining a more numerous array of ^{90}Sr contamination data, in order to reconstruct the transuraniums contamination levels on the 30 km zone of the Chernobyl NPP as well as on more remote regions.

However, the results obtained during further investigations testify that such approach can lead to considerable errors. Practically on the boundary of the 30 km zone of ChNPP in the direction of the south-west trace, a significant abnormality was established for values of $^{90}\text{Sr}/^{239+240}\text{Pu}$ ratio (Fig. 7), compared

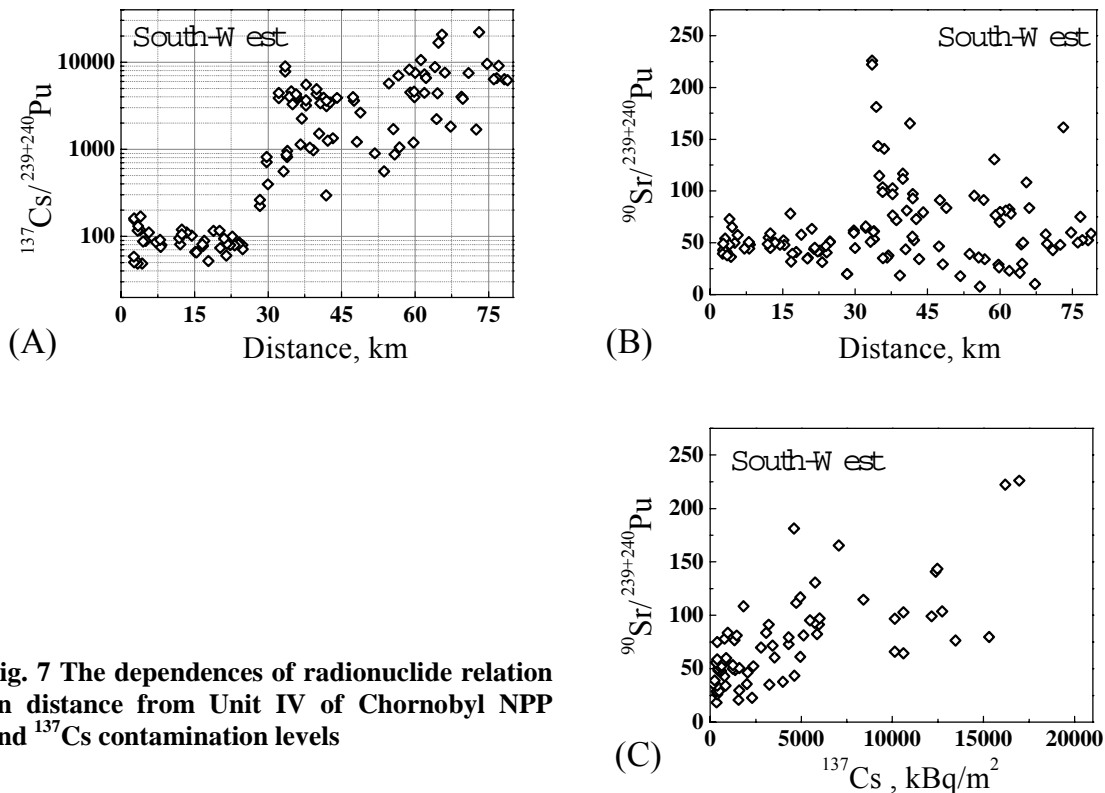

Fig. 7 The dependences of radionuclide relation on distance from Unit IV of Chernobyl NPP and ^{137}Cs contamination levels

with the corresponding values in Fig. 6. Analysis of the dependency of $^{90}\text{Sr}/^{239+240}\text{Pu}$ values on the ^{137}Cs contamination levels (Fig 7C) indicates a similar behavior of ^{90}Sr to that of ^{137}Cs , which permits to suppose that the vaporized-condensed component was significant in the formation of ^{90}Sr contamination on this region. More distinctly this contribution is observed on the territory of more remote regions along the south and the north-east traces [15, 23].

As it was mentioned above, the drastically inhomogeneous spatial distribution of radionuclide depositions on the adjacent territory to Chornobyl NPP does not permit to make quantitative and detailed contamination maps based just on the data of soil samples measurements, even under high density of investigated plots [21]. Thereafter, taking into consideration local tendencies of radionuclide composition and their regularities, new technique has been developed for mapping of contamination by transuraniums and ^{90}Sr [23]. This technique includes:

- unification and preliminary verification of all available data;
- compilation of the regular data grid for the most detailed studied long-lived radionuclide (^{137}Cs);
- investigations of radionuclide composition and local peculiarities of contamination;
- compilation of the regular grid data for the less studied radionuclide (^{90}Sr or transuraniums) on the base of the established local regularities of their ratios to the most studied radionuclide (^{137}Cs).

Using the new proposed technique, the narrow-shaped west trace of the ^{90}Sr and $^{238+239+240}\text{Pu}$ contaminations have been clearly reconstructed on the maps (Fig. 8). The high levels of ^{90}Sr and transuraniums contamination are observed on the wide south areas of the adjacent territory to ChNPP, where the contamination is dominated by fuel component. At the same time, on the territory of the south-west trace (outside the 30 km zone), the condensation character of ^{137}Cs contaminations resulted in the essential distinctions in the high levels of ^{137}Cs compared with transuraniums contamination. On this territory the levels of ^{137}Cs can exceed $15 \text{ Ci}/\text{km}^2$ ($555 \text{ kBq}/\text{m}^2$), while the corresponding levels of transuraniums practically tend to be global one.

The analysis of $^{238}\text{Pu}/^{239+240}\text{Pu}$ ratios permitted to evaluate the contribution of Chornobyl depositions of transuranium elements on the background by global ones. It should be noted that the global levels of transuraniums on the territory of Ukraine are known only roughly: the corresponding $^{239+240}\text{Pu}$ values are within $0.04\text{-}0.12 \text{ kBq}/\text{m}^2$. The values of $^{238}\text{Pu}/^{239+240}\text{Pu}$ ratio for global fallouts are more fixed and are

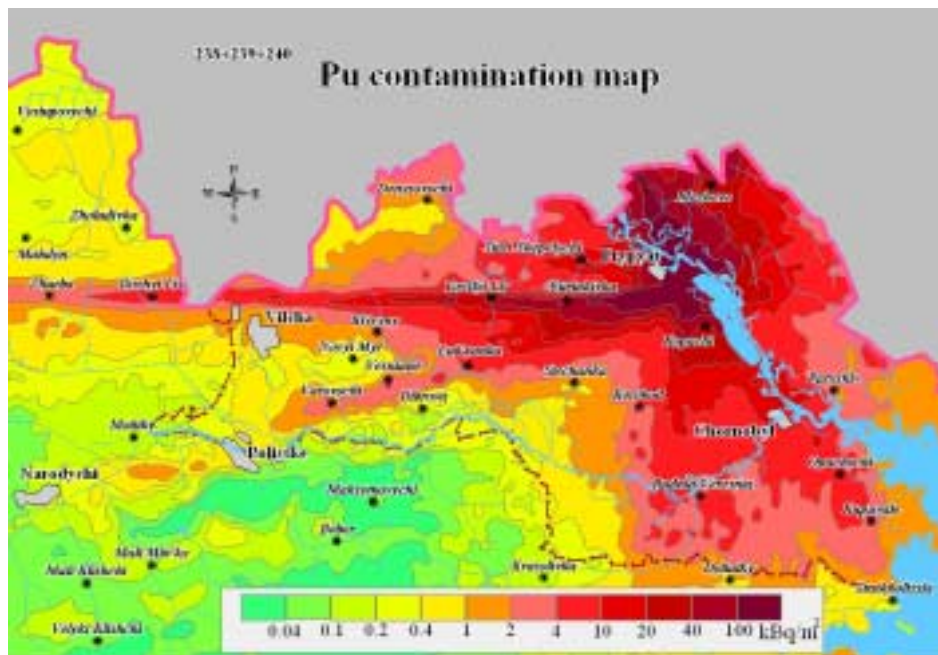

Fig. 8. $^{238+239+240}\text{Pu}$ contamination map of the adjacent territory to Chornobyl NPP (Ukrainian part).

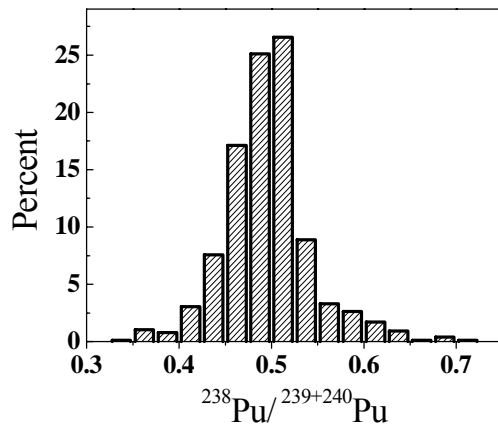

Fig. 9. Distribution of values for $^{238}\text{Pu}/^{239}\text{Pu}$ obtained within 30-km Chernobyl NPP.

within the range of 0.02-0.04 [24,25]. In general, the values of $^{238}\text{Pu}/^{239+240}\text{Pu}$ in Chernobyl depositions can vary due to the different fuel burnup in different parts of the core [16,17]. However, the numerous data obtained on the nearest Chernobyl NPP zone indicate that the corresponding values are practically within the range of 0.4-0.6 (Fig. 9). Thus, the sharp distinction in the ratio of $^{238}\text{Pu}/^{239+240}\text{Pu}$ between for global and for Chernobyl depositions permits to evaluate the contribution from different origins.

The Chernobyl part in the contamination of transuraniums has practical significance for forecasting of the radioecological situation on the contaminated territories.

The dynamics of the radioecological situation is determined mainly by radioactive decay and vertical migration of radionuclides [26]. The only exception is ^{241}Am (half-life 433 yr). The main part of ^{241}Am in Chernobyl depositions is formed as a result of beta-decay of ^{241}Pu parent nuclei (half-life 14.35 yr). By this reason the ^{241}Am contamination levels are increasing at present and will reach maximum about 2060. By that time the alpha-activity of ^{241}Am will be practically twice as the gross activity of alpha-emitting plutonium isotopes (for the area where contamination is determined by Chernobyl fallouts) (Fig.10). This fact should be kept in mind when forecasting the radioecological situation in the adjacent territory to

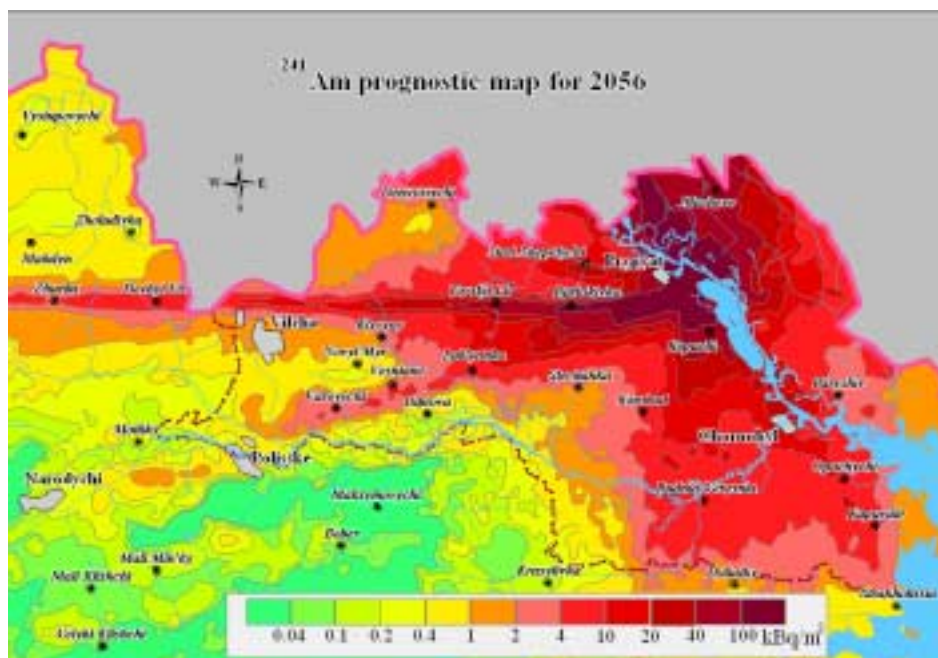

Fig. 10. ^{241}Am prognostic map of exclusion zone and adjacent territory for 2056 Ukrainian part).

ChNPP.

Landscape factors and their influence on the formation of contamination structure

As described above, more detailed and accurate contamination maps than ever have been elaborated by new techniques. New techniques, in addition, have brought to light on some questions about the Chernobyl depositions: strange shapes of traces and spots, and the peculiarities of the radionuclide composition of depositions (often for the neighbouring regions).

At present there are numerous model calculations to explain the spatial distribution of Chernobyl fallouts based on the synoptic maps in the scale of European part of the former USSR or the European continent. Due to the lack of information about releases parameters and meteorological data, the uncertainty in the input parameters for calculations led to discrepancy in the results obtained by different authors [8,27,28]. Furthermore, practically all of them could not explain the detailed shape of the contamination spots under local-scale mapping [29]. It must be noted that the complicated character of the interaction between the air streams and the underlying surface was considered in these models only partially [30].

Therefore, it was interesting to perform comprehensive analysis of the improved radioecological data and the landscape factors to determine a role of the latter on the shaping of a primary contamination. Modern GIS techniques provide an opportunity to link and analyse simultaneously several layers of information (contamination level isolines, surface geometry, location of forestry, rivers, settlements etc.) [31]. Results of such analysis can be presented as three- or multi-dimensional drawings .

The interaction between the ground surface and the atmosphere depends significantly upon meteorological condition [30]. During the active stage of the accident releases these conditions were essentially changing [4, 7, 8 , 28].

During April 25-26, 1986, the Chernobyl NPP region was situated in the low gradient barometric field of the anti-cyclone periphery part. Such condition determined the considerable changes of wind direction under weak speed of it (up to 2-3 m/s). At night, the air stream directions at the ground surface might be different from the wind direction at height 1.5-2.5 km up to 45-50°. At the near surface layer the dominating directions of the contaminated air mass flow were west and south-west but, while at the layer

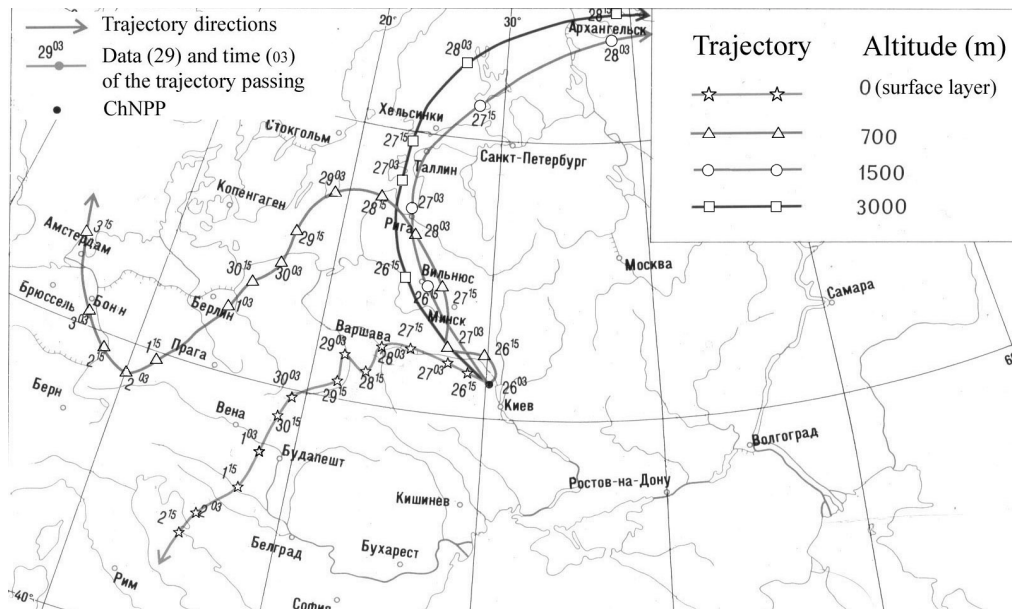

Fig. 11. Trajectories of radioactivity transport that started on 26 April, 1986 at 3:00 from Unit-IV of Chernobyl NPP by atmosphere layers in different height.

of 1.5-2.0 km high the corresponding directions might be west or north-west (Fig. 11) [7]. The stable conditions in the boundary layer were observed during the night. As a result of weak atmosphere perturbation, the narrow-shaped “explosion” west trace was formed (Chornobyl NPP-Vilcha-Pershotravneve). At the same time, the air stream at height more than 1 km, which was enriched in volatile radionuclides, started to move in the north-west direction. During April 27 the speed and the direction of the air mass transport remained without considerable changes. During April 28-30 the directions of transport considerably changed and practically made rotation on 360°, while the wind speed remained weak.

During May 1-6 a considerable increase of wind speed was observed (on May 2-3 gale-force wind). The contaminated air masses were being transported predominantly in the south direction (south-east on May 4 and south-west on May 5). This period is characterised by a more uniform distribution of the wind speed and the direction along the atmosphere layers at different heights. Also must be noted the increasing of the boundary layer height and the intensity of diffusion processes. During this period the wide south trace was formed.

Thus, the contamination fields on the territory of Ukraine in the west (north-west, south-west) and south directions were formed under different meteorological conditions. It is reasonable to expect (because of more quiet atmospheric conditions) the most noticeable influence of landscape factors on the formation of the contamination fields in west and south-west direction from Unit IV of Chornobyl NPP [30]. Multi-dimensional topographic maps of the corresponding territories were constructed on the basis of improved digital techniques. This gave a possibility to analyse the radiological data in the form of the superposed colour isolines together with the landscape features of the area.

As a result of multi-dimensional view visual analysis the followings were found:

- correlation between the location of highly contaminated areas and the elevation of forestland locations;
- under the condition of low-gradient barometric fields the river flood-planes became the guiding lines for contaminated air streams, especially in west and south-west directions;
- influence of the chain of hills and the mountain-valley wind on the streamline of air mass propagation.

In the light of above-mentioned findings the strange shape of Narodychi “horseshoe” (near 70 km south-west from Chornobyl NPP, Fig. 12) can be explained by the interaction of forestlands with passing air currents above them. The radioactively polluted air masses, which had overcome the Chystohalivka ridge, passed the low laying area without noticeable deposition on it (Figs. 12 and 13).

Strong perturbations of air currents at the region of the forest-covered hills caused considerable increasing of fallout depositions. It must be noted that fallouts in this case were originated from atmosphere layers up to 1.5-2.5 km. Experimental data obtained for radionuclide composition on the corresponding territory can be considered as an evidence of the proposed model. As it was mentioned earlier, the domination of ^{137}Cs and considerable ^{90}Sr contamination were found on this area. Such peculiarities of contamination (radionuclide composition) are also observed for more remote regions where depositions were caused by fallout from the top atmosphere layers, while Narodychi “horseshoe” situated not far than 70 km from Unit-IV of Chornobyl NPP.

The suggested landscape approach was also fruitful for explanation of a number of phenomena. The minor change of the direction of the narrow “explosion” west trace was caused by the influence of the Chystohalivka chain of hills (about 6 km south-west from Chornobyl NPP). The perturbation of the air-flow at this area resulted in significant increasing of fallouts at the northern slopes of the Chystohalivka chain of hills due to depletion of passing air currents. Though the height of the Chystohalivka chain of hills does not exceed 200 m, the formation of low contaminated wedge-shaped region in the south-west part of the exclusion zone can be explained by its influence. The depleted air current passed over the comparatively low altitude area (village Stechanka in Fig. 4) and then went onto the higher one (Narodychi-Bober), forming the observed shape of the contamination field.

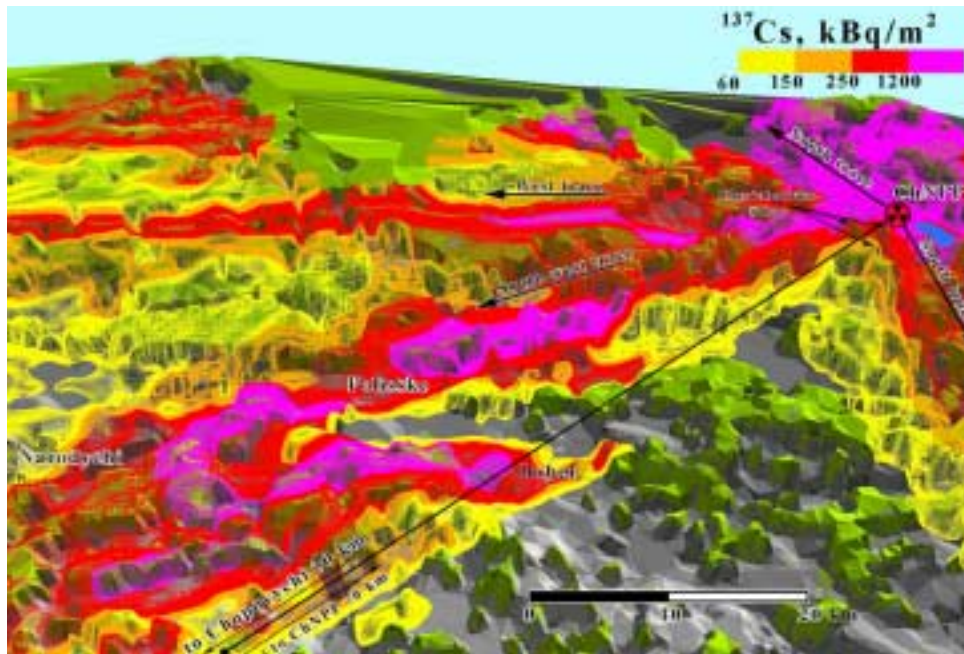

Fig. 12. The view of territory of Narodychi “horseshoe” with isolines of ^{137}Cs contamination levels.

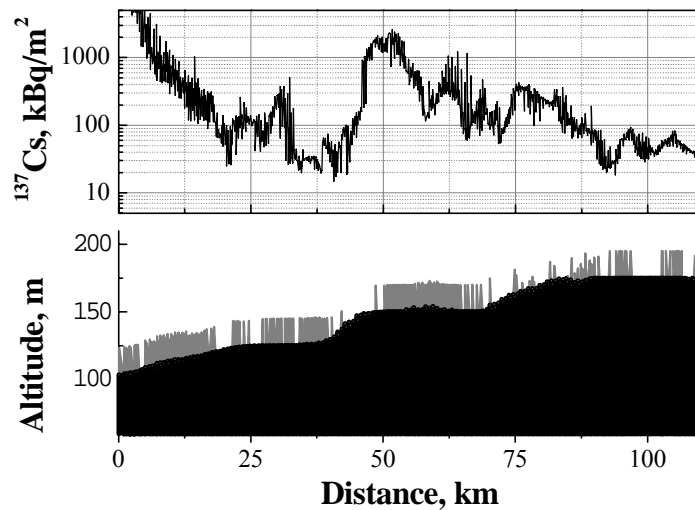

Fig. 13. The dependence of ^{137}Cs contamination levels on distance from Unit IV of Chernobyl NPP (along line Chernobyl NPP - Chopovychi) and relief cross-section (solid black colour) with marked forestry location (grey colour).

Luhyny “horseshoe” (about 100 km west from Chernobyl NPP) was formed as a result of the air current dividing into two streams by natural “stem cutting bar” (to north–east from village Ihnatpil, at the left-bottom part in Fig. 14). The forestry on the path of these streams resulted in strong air distortion and significant increasing of fallout depositions.

A very specific character of the narrow-shaped “explosion” west trace, radionuclide composition of which is featured by a large fraction of fuel component, was studied taking into account the influence of landscape factors on the propagation of contaminated air masses on the territory. As a result of the strong perturbations of air currents on the north-east slope of the Ovruch ridge, the narrow shape of the “explosion” west trace was significantly widened (in the right-bottom part in Fig. 14).

Considerable decreasing of the contamination levels at this area can be interpreted as the ending of the trace. However, the analysis of multi-dimensional views for this area provided a reason to suppose that

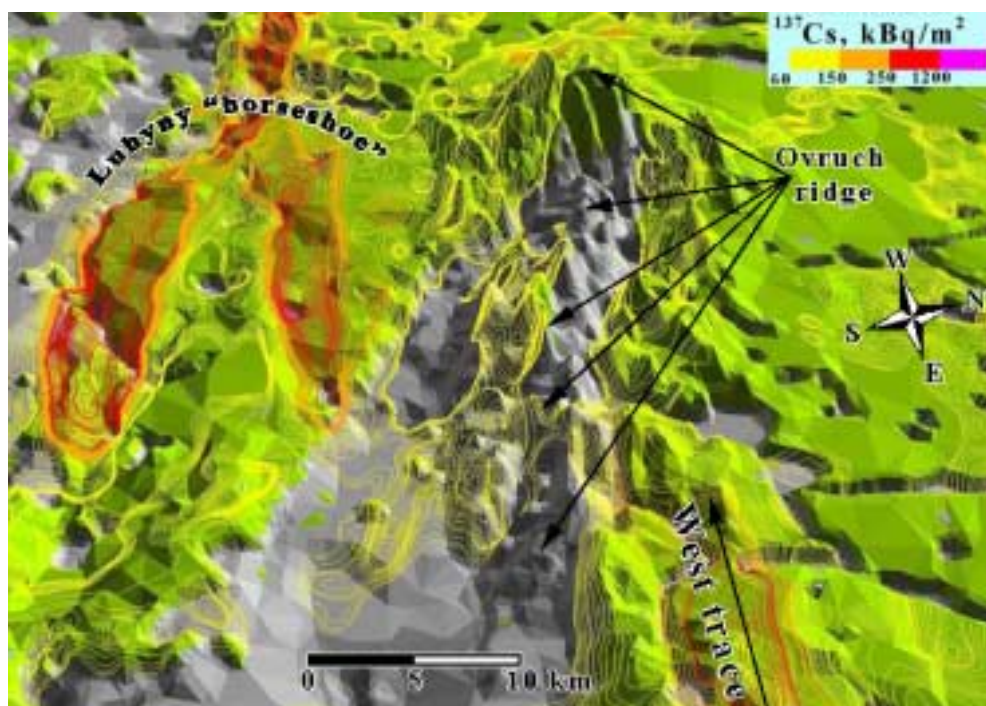

Fig. 14. The view of region of Luhyny “horseshoe” (in west direction) with isolines of ^{137}Cs contamination levels.

the “explosion” west trace after dividing into several streams surmounted the ridge. In order to check this assumption a special investigation on the north and north-west slopes of the Ovruch ridge and Luhyny “horseshoe” was carried out in 2001. Then, it was found that on the north slopes of the Ovruch ridge contamination levels of $^{238+239+240}\text{Pu}$ were more than 0.5 kBq/m^2 and the fuel component in contamination was evaluated as 20 percent. The similar radionuclide composition was found also on the north-west slopes of the Ovruch ridge, while the density of contamination was lower. At the same time, on the territory of Luhyny “horseshoe” contamination levels of $^{238+239+240}\text{Pu}$ did not exceed 0.2 kBq/m^2 and the contribution of fuel component was less than 3 percent. So, it is evident that the contaminations of Luhyny “horseshoe” and the north-west slopes of the Ovruch ridge, despite of being neighbouring, were formed by different processes in different air streams.

Thus the integrated study of the various information layers provided the possibility to evaluate the contribution of various factors to the processes of formation of the contamination structure. The obtained results testify to the necessity of more careful investigation of the interaction processes between the ground surface and the radioactive air currents.

Conclusions

- Investigations of the Chernobyl contamination of the adjacent territory to ChNPP carried out in 1986-1989 provided necessary basic information for radiological protection of population but were unable to reveal regional tendencies and specific features of contamination, and consequently to explain the observed picture of contamination.
- Further investigations of Chernobyl contamination using GIS-oriented advanced modern techniques, which include special procedures for sampling, measurements of radionuclide specific activity in soils and data analysis, provided the possibility to obtain reliable set of experimental data and to compile improved detailed maps of ^{137}Cs , ^{90}Sr , ^{241}Am and plutonium isotopes contamination of the adjacent territory to Chernobyl NPP.
- The detailed data obtained for the structure of the Chernobyl deposition permitted to verify the existing

models of propagation and deposition of radioactive releases.

- Landscape factors significantly influenced the processes of the air currents propagation from Chernobyl NPP and shaping of contamination areas especially on condition of the low gradient barometric field that continued during the first two days of the accident.
- Landscape approach together with meteorological modelling seems to be the most fruitful method for explanation of the shapes and the radionuclide composition of radioactive traces on the local scale mappings.

References

1. Atlas on Caesium Deposition on Europe after the Chernobyl Accident. London, Lovell Jons Ltd., 1998, 175 p.
2. Izrael Yu.A. Radioactive Pollution after nuclear explosions and accidents – integral approach. // Proceedings of international conference "Radioactivity after nuclear explosions and accidents", Moskow, 2000, Sankt-Peterburg, Hydrometeoizdat, 2000 (in Russ.)
3. Kiselev A.N., Checherov K.P. The model of destruction process of the unit-4 thr Chernobyl NPP. *Atomnaya Energiya*, 2001, v. 91, N6, p. 425-434 (in Russ.)
4. "Chernobyl: Contamination in the Environment. Edited by Y.A.Izrael. Leningrad. Gidrometeoizdat. 1990 (in Russ.)
5. "Information to IAEA about the Chernobyl NPP Accident". *Atomnaya Energiya*, 1986, v. 61, N5, p. 301-320 (in Russ.)
6. Borovoy A.A., Gegerinsky A.Yu. Release of radioactivity from destroyed unit of the Chernobyl NPP. *Atomnaya energia*. 2001, v.90, N2, p. 137-145 (in Russ.)
7. Atlas of radioactive contamination of European Russia, Belarus and Ukraine. /Elaborated at Institute of Global Climate and Ecology under Roshydromet and Russian Academy of Science under scientific supervision of Ac. Izrael Yu.A. Moscow. Federal Service of Geodesy and Cartography of Russia. 1998. 143 p. (in Russ.)
8. Borzilov V.F., Klepikova N.V., Kostrikov A.A. at al. Meteorological conditions of long-range transport of ChNPP radioactivity. *Meteorologia i gidrologiya*, 1989, N1, p.5-11 (in Russ.)
9. Devel L., Guntay S., Powers D. The Chernobyl reactor accident sours term. OCDE/GD 1996, (12), Paris. 29 p.
10. Fifteen years of Chornobyl catastrophe. experience of overcoming// National Report of Ukraine, Kyiv,2001 (in Ukr.)
11. Belarus and Chernobyl: The second decade// Ed. by H.E. Minister I.A. Kenik - Minsk: Ministry of Emergencies of the Republic of Belarus, 1998, - 92 p.
12. Chernobyl catastrophe. Results and the problems of overcoming its consequences in Russia 1986-2001// National Report of Russia, Moscow, 2001
13. Results of investigations of radioactive contamination of 60-km radius zone around Chernobyl NPP using airborne-gamma-spectrum survey and plane-table set.// Proceedings of international conference "Radioactivity after nuclear explosions and accidents", Moskow, April 24-26, 2000, Sankt-Peterburg, Hydrometeoizdat, 2000 (in Russ.)
14. Kvasnikova E.V., Pegoev A.N., Stukin E.D. Modern radionuclide contain of the Chernobyl deposition on the different distance from the location of the accident. // Proceedings of international conference "Radioactivity after nuclear explosions and accidents", Moskow, April 24-26, 2000, Sankt-Peterburg, Hydrometeoizdat, 2000 (in Russ.)
15. Arutunjan R.V., Bolshov L.A., Vasilieva S.K. at al. Spatial regularity of radionuclide contamination caused by accident on ChNPP. *Atomnaya Energiya*, v.61, N6, 1993, p.453-457 (in Russ.)
16. Bogatov S.A., Borovoy A.A., Dubasov Yu.V. et al. Form and characteristics of fuel particles from ChNPP accident release. *Atomnaya Energiya*, v.69, N.1, 1990, c.36-40 (in Russ.)
17. Loshilov N.A., Kashparov V.A., Polyakov V.D. at al. Nuclear-physical characteristics of hot particles caused by ChNPP accident. *Radiochimiya*, N4, 1992, p.113-119 (in Russ.)
18. Davydechuk V.S., Zarudnaya R.F., Mikheli S.V. Landscapes of the Chernobyl zone and their assessment by the condition of radionuclides migration. Kyiv, Naukova Dumka, 1994 (in Ukr.)
19. Buletен ekologichnogo stanu zoni vidchudgennya ta zoni bezumovnogo (obov'yaskovogo) vidselenya, N5, 1995, p.20-21 (in Ukr.)

20. Gricenko N.N., Nechaeva N.S., Malachov et al. The radioactive contamination of exclusion zone of Zhitomir and Kyiv regions. Buletен ekologichnogo stanu zoni vidchudgennya ta zoni bezumovnogo (obov'yaskovogo) vidselenya, N11, 1995, p.15-17 (in Ukr.)
21. Ageev V.A., Virichek S.L., Gaydar A.V. et al. The contamination of the Chernobyl exclusion zone by long-lived radionuclides. The object "Shelter" – 10 years, the basic results of scientific researches. Chernobyl, 1996, p.140-147(in Russ.)
22. Lyovshin E.B., Ageev V.A., Gaydar A.V. et al. Transuranium elements in the exclusion zone. Buletен ekologichnogo stanu zoni vidchudgennya ta zoni bezumovnogo (obov'yaskovogo) vidselenya, N13, 1999, p.57-59 (in Ukr.)
23. Vishnevsky I.N., Gaydar A.V., Lyovshin E.B. et al. The compiling of the deposition maps of long lived radionuclides on the territory of Ukraine. // Proceedings of international conference "Radioactivity after nuclear explosions and accidents", Moskow, 2000, Sankt-Peterburg, Hydrometeoizdat, 2000 (in Russ.)
24. Belyaev B.N., Gavrilov V.M., Domkin B.D. et al. Plutonium isotope content in soil and possibilities of contamination source identification. Atomnaya Energia, v.83, N4, 1997, p. 298-303 (in Russ.)
25. Bunzl K., Forster H., Kracke W. et al. Residence times off Fallout $^{239+240}\text{Pu}$, ^{238}Pu , ^{241}Am and ^{137}Cs in the upper horizons of an undisturbed grassland soil. J. Environ. Radioactivity, 1994, v.22, N.1, p.11-27
26. Izrael Yu.A., Imshennik E.V., Kvashnikova E.V. et al. Long-range forecast of changes of radioactive contamination on territory of Russia by ^{137}Cs after accident in Chernobyl NPP. Meteorologia i gidrologiya, 1998, N4, p.5-17 (in Russ.)
27. Izrael Yu.A., Petrov V.N., Severov D.A. Regional model of transport and radionuclide fallout due to ChNPP catastrophe. Meteorologia i gidrologiya, 1989, N6, p. 5-13 (in Russ.)
28. Buikov M.V., Garger E.K., Talerko N.N. Study of spotty structure of radioactive fallout by means of Lagrangian-Euler model. Meteorologia i gidrologiya. 1992, N12, p.33-45 (in Russ.)
29. Izrael Yu.A., Petrov V.N., Severov D.A. Radioactive fallout modelling for the nearest Chernobyl NPP zone. Meteorologia i gidrologiya. 1987, N7, p. 5-11 (in Russ.)
30. Meteorology and nuclear energy. /Edited by Bizova N.I. and Machonko K.P. Leningrad, Gidrometeoizdat, 1971, 648 p. (in Russ.)
31. Gaidar A.V., Tabachny L.Ya., Foursat A.D. Chornomorets N.F. Effect of landscape on the formation of the contamination structure on adjacent to ChNPP territory. Buletен ekologichnogo stanu zoni vidchudgennya ta zoni bezumovnogo (obov'yaskovogo) vidselenya, 2000, N15, p. 58-61 (in Ukr.)
32. Beschasnov S.P., Naydenov A.V. Diffusion models of gas-aerosol current for local system of radiation monitoring. Atomnaya Energia, v.88, N6, 2000, p. 464-470 (in Russ.)

Radioecological Situation in the Cooling Pond of Chernobyl NPP

Oleg NASVIT

Research Innovative Implementation Enterprise “Stroom”, Office “Stroom-Kyiv”
28A, Artema St., Kyiv, 04053, Ukraine: nasvit@public.icyb.kiev.ua

Abstract

Analysis of the monitoring data on the radionuclides specific activity in water of the Cooling Pond of Chernobyl NPP revealed the regular seasonal cycling of the ^{137}Cs concentration but did not reveal this for ^{90}Sr . It is strongly supposed that this phenomenon is caused by the microbial-controlled seasonal dependant flux of ^{137}Cs from the bottom sediments to the water. Analysis of the ^{137}Cs profiles in deep water sediment (silt) provides additional forcible argument in favour of this supposition.

The data obtained during radioecological survey carried out in August 2001 proved that on the eve of its decommissioning the Cooling Pond of Chernobyl NPP entered the stage of stabilisation of radioecological situation. The amounts of major radionuclides accumulated in the bottom sediments of the Cooling Pond are estimated to be 4,400, 650 and 18 Ci for ^{137}Cs , ^{90}Sr and ^{241}Am , respectively. About 70% of ^{137}Cs , 50% of ^{90}Sr and 80% of ^{241}Am that are present in the Cooling Pond will remain under the water after the water level will have been dropped down to the natural elevation. The data on the concentration of ^{137}Cs and ^{90}Sr in different fish and water plant species as well as in bivale mollusc *Dreissena* are also presented.

1. Introduction

The Cooling Pond of the Chernobyl Nuclear Power Plant, which is situated in the northern part of Ukraine, is an artificial reservoir, created on the right-bank flood plain of Prypiat river for cooling of four reactor units of NPP. Banks of the Cooling Pond are formed by both an above-land terracing of the river and a protecting dike of 25 km in length. The diked-off area includes river bed, old arms and lakes. The water surface area of the Cooling Pond is about 22 km², volume – about 0.15 km³, length – 11 km, and width – 2 km. The mean depth of the Cooling Pond is 6.6 m, maximum depth – about 18 m, and water elevation 5-7 m over the Prypiat river level. To compensate water losses due to leakage and evaporation, water is permanently pumped from Prypiat river to the Cooling Pond.

After a devastating accident happened at Chernobyl NPP on 26 April 1986, a large amount of radioactive materials released from the completely destroyed Unit #4 caused radioactive contamination of the environment, especially severe in the vicinity of NPP.

The Cooling Pond on the bank of which Chernobyl NPP is situated was contaminated by radioactive fallout, mainly dispersed fuel particles that fell directly on the water surface. In addition, 5,000 m³ of heavily contaminated water from the reactor basement was released to the Cooling Pond, and during the decontamination activities a massive amount of soil removed from the nearby sites with high level of

Table 1. ^{137}Cs and ^{90}Sr in components of Cooling Pond ecosystem in Summer 1986, kBq/kg f.w., kBq/l [2].

Component	^{137}Cs	^{90}Sr
Water, up to	1.7	0.05
Bottom sediments	10-380	1-100
Aquatic plants	50-180	15-45
Molluscs	18-35	35-60
Fish (carp)	100-260	2-3

radiation was also placed in the Cooling Pond [1]. According to various estimates, the Cooling Pond in total received from 2,200 to 13,000 TBq (60 to 360 thousands Ci) of radionuclides [1, 2, 3]. Specific gross-beta activity of water in the beginning of May, 1986 was about 10^5 Bq/l, mainly due to ^{131}I and other short-living radionuclides. Radioecological investigations performed in Summer, 1986, showed high levels of ^{137}Cs and ^{90}Sr specific activity in all components of the Cooling Pond ecosystem (Table 1).

During 1986 due to physical decay short-living radionuclides gradually eliminated from the spectrum of radioactive contamination of the Cooling Pond ecosystem, and about 95-98% of remaining radioactivity, including long-living nuclides such as ^{137}Cs , ^{90}Sr , $^{238, 239, 240, 241}\text{Pu}$ and ^{241}Am settled to the bottom due to processes of sedimentation. After survey of bottom sediments had been carried out in 1989 and 1991, the estimates was done of the inventory of long-living radionuclides in the Cooling Pond. According to these estimates the Cooling Pond contains about 170 TBq (4,600 Ci) of ^{137}Cs , 35 TBq (950 Ci) of ^{90}Sr and 0.8 TBq (22 Ci) of $^{239, 240}\text{Pu}$ [1].

In December 2000, the Unit #3, the last operating one at Chernobyl Nuclear Power Plant was shut down. In some years Chernobyl NPP will not need the Cooling Pond anymore. Considering the future fate of the Cooling Pond and respective necessary actions, one should take into account the followings: from one hand, keeping the existing water level is rather expensive and, from the other hand, leaving the Cooling Pond without pumping of water from the river would drain a large part of bottom and may cause radiological problems for personnel of the industrial site due to wind resuspension of dried sediments containing transuranics.

The problem of possible resuspension of bottom sediments is being studied now in a number of projects. But another side of the problem, i.e. what will happen to water bodies, which will remain on the place of the Cooling Pond after it will have been drained, is still without proper attention of radioecologists. Assessment of the future state of the Cooling Pond is possible only on the basis of comprehensive description of the existing situation and using of validated models of radionuclides migration which take into account specificity of biological processes during the transition period.

The objectives of this work are to summarise the existing information on the levels of radioactive contamination of the components of the Cooling Pond ecosystem, to reveal probable processes governing these levels of radioactive contamination, and to provide the information to forecast the future radioecological situation in this water-body.

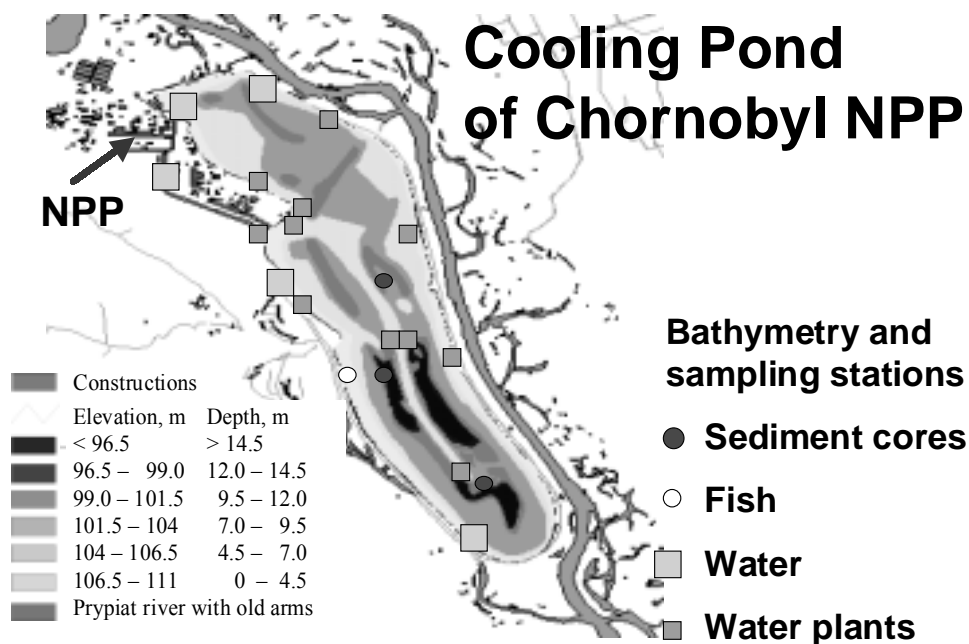

Fig. 1. Scheme of the Cooling Pond of Chernobyl NPP with bathymetry and sampling stations location.

2. Materials and Methods

2.1. Water samples

Water samples from the Cooling Pond were taken at the regular intervals since the beginning of 1987 within the program of radioecological monitoring of the exclusion zone. During 1987 samples were taken 4 – 6 times per month, in 1988 – 2 times per month, since 1989 and up to now – monthly. The number of sample sites varied from 5 to 10. During 1987 – 1992 from 1 to 10 litres were sampled for total (without separation for suspended and dissolved fractions) ^{137}Cs and ^{90}Sr activity determination. In 1987 – 1988 direct gamma-spectrometric measurements of water samples were performed. In 1989 – 1992 ^{137}Cs was collected by sorption on FEZHEL (potassium-iron ferrocyanide) at natural pH without prior filtration of the water.

Since 1993 surface water samples are taken at 5 sites shown in Fig. 1. On each site a sample of 20 l is taken. In the laboratory sample is filtered through paper filter (blue band), and dissolved ^{137}Cs is collected by sorption on FEZHEL at natural pH. Filter and sorbent are measured separately for determination of associated with suspended matter and dissolved ^{137}Cs .

Since 1997 the radiochemical isolation of ^{90}Sr from water by the sulphate method [4], which was used since the beginning of regular observations, was modified and collection by sorption (complexation) on VS-15M1 (synthetic selective sorption fibre material with grafted macro cycles groups) at natural pH was introduced at the first stage [5].

2.2. Bottom sediments samples

Samples of bottom sediments were collected in July and August 2001 with ДТШ-3 (DETESHA-3) corer at water depths 0 – 6 m, and a weighted gravity coring rig with 70 cm transparent cylindrical nozzle was used at water depths more than 6 m. For investigation of the depth distribution as well as the total inventory of ^{137}Cs in deep-water sediments, cores (5.8 cm diameter and up to 70 cm long) were cut on site into slices as a rule 5 cm thick, but in a number of cases the slice thickness was adjusted to observed natural boundaries of core material with different properties.

Cores of shallow sediments (water depth less than 6 m), represented by sands, silted sands and transformed primary soils were cut into three layers: 1 cm top, 1 cm bottom, the rest. All sediment samples were analysed for bulk density, content of water and radionuclides.

2.3. Biotic samples

Biotic samples were taken in August, 2001 during radioecological survey of the Cooling Pond.

Fish was sampled by fishing net. All fishes were caught at the same site shown in Fig. 1. Each fish was weighted and measured in length. About 100 g of fresh muscle tissue was dissected from each fish and packed into plastic vials for ^{137}Cs measurements. Selected samples were taken for ^{90}Sr analysis. Scales were taken from each fish for determination of age.

Dreissena molluscs were collected from concrete hydrotechnical constructions with scraper or from bottom (3-7 m depth) with dredger together with sediments sampling, and ground for analysis.

Plants were collected in the littoral zone at 11 sites around the Cooling Pond. The above-sediment parts of plants were sampled. Plant tissues were rinsed, air-dried and ground for analysis. The fresh and dry weight was determined.

Seston samples were collected with phytoplankton net (gauze Nr. 76) in pileup of planktonic algae, mainly blue-green. Samples were air-dried, weighted and ground for analysis.

Samples of invertebrates, plants and seston were measured for ^{137}Cs . Selected samples were taken for ^{90}Sr analysis.

2.3. Radioactivity measurements.

Gamma-spectrometry was performed using Ge(Li) detector and MCA. Beta-measurements were performed using beta-spectrometer AKC-1 and low-background counting devices UMF-1500M.

3. Results and discussion

3.1. Water

Annually averaged specific activities of total ^{137}Cs and ^{90}Sr in water of the Cooling Pond are presented in Fig. 2. In general this data is in good agreement with the results presented earlier for 1986 – 1995 [2, 6]. It is well known that ^{137}Cs and ^{90}Sr content in water is influenced by several main processes. Among them the interaction in a system “water-suspended matter-bottom sediments” is of major importance for water-bodies with medium and high level of biological productivity and/or high level of suspended particles concentration. During the first year after the accident the observed fast declining of ^{137}Cs and ^{90}Sr specific activity in water was caused by their trapping with suspended matter and settling to the bottom. Slowing down of declining for ^{137}Cs and even increasing of concentrations of ^{90}Sr observed in

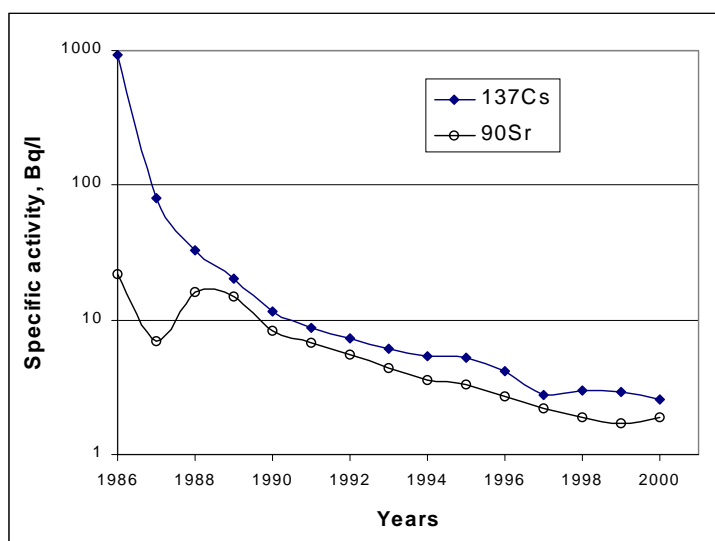

Fig. 2. Total ^{137}Cs and ^{90}Sr in water of the Cooling Pond, annually averaged.

the third and fourth years were caused, probably, by the additional release of these radionuclides to water from the fuel particles due to their destruction. From 1990 to 1997 almost equal declining of both radionuclides was observed and since 1997 both radionuclides tend to have about stable concentration. Some minor discrepancies in figures and declining rates between ^{137}Cs and ^{90}Sr specific activities for 1992-1995 presented in publications [2, 6] and in Fig. 2 could be explained by the fact that the latter was provided on the basis of more regular observations.

Monthly averaged specific activities of total ^{137}Cs and ^{90}Sr in water of the Cooling Pond are presented in Fig. 3. As it could be seen from Fig. 3 regular observations of ^{137}Cs in the Cooling Pond water providing the possibility of the analysis on monthly basis were started in late 1986 (actually in December) and of ^{90}Sr – in spring 1988, although this analysis has never been done before. It was just noticed that higher specific activities of ^{137}Cs in water of the Cooling Pond were observed usually in summer and during the year the variations with a factor of 2-3 were observed. If one get a look of plots presenting monthly averaged specific activities of total ^{137}Cs and ^{90}Sr in water of the Cooling Pond on the background of grid-lines marking the beginning of the year (Fig. 3), he could assume the presence of regular seasonal changes of at least ^{137}Cs concentrations.

To reveal the seasonal regularities the period of 1993 – 2000 was taken as less influenced by general processes of radionuclide concentration reduction. For this period the detailed analysis of seasonal

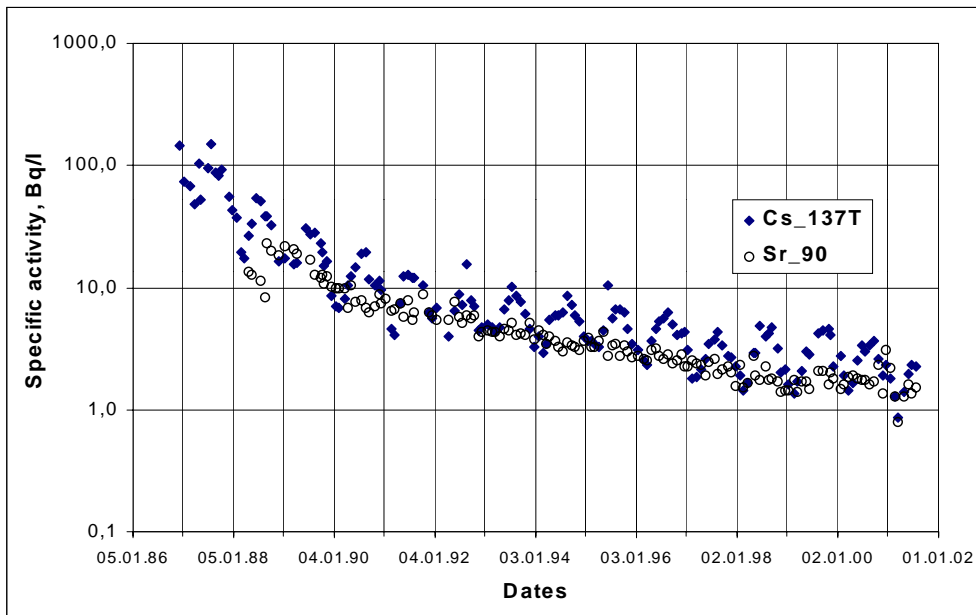

Fig. 3. Total ¹³⁷Cs and ⁹⁰Sr in water of the Cooling Pond, monthly averaged.

behaviour of the total ¹³⁷Cs and ⁹⁰Sr specific activity in water was performed and the general trends were found (Fig. 4). Using the regression lines in Fig. 4, the seasonal component of specific activity changes was extracted (Fig. 5). The relative units in chart represent the ratios of the actual monthly data to the respective calculated values (regression lines) and the confidence intervals represent the standard deviation values.

As it could be seen from Fig. 5, ⁹⁰Sr does not tend to show the seasonal changes. To the contrary, ¹³⁷Cs strongly tends to show the regular seasonal changes with minimum values in February-March and maximum – in June-September with August values exceeding that of February by a factor of 2.5.

There are two main ideas of explanation of the revealed phenomenon. The first is the presence of seasonally dependant flux of ¹³⁷Cs to water from the bottom sediments. The second is the seasonal development of plankton organisms that would influence the total ¹³⁷Cs specific activity in water. To check the possible influence of the seasonal plankton development the seasonal behaviour of a ratio of suspended to total ¹³⁷Cs in water was studied. It was found that the highest contribution of suspended ¹³⁷Cs

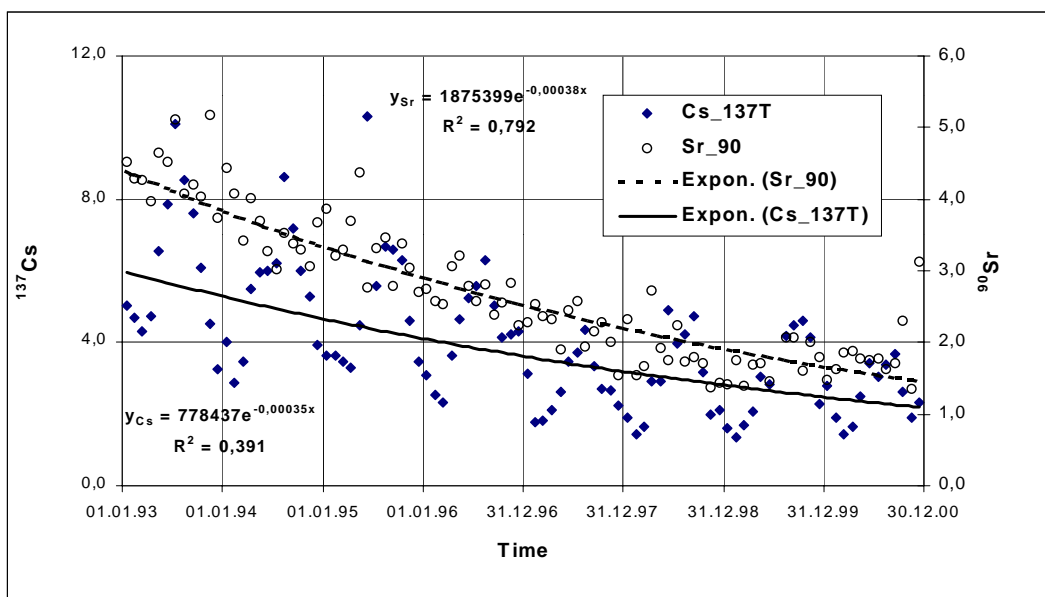

Fig. 4. Total ¹³⁷Cs and ⁹⁰Sr in water of the Cooling Pond in 1993 - 2000, monthly averaged, Bq/l.

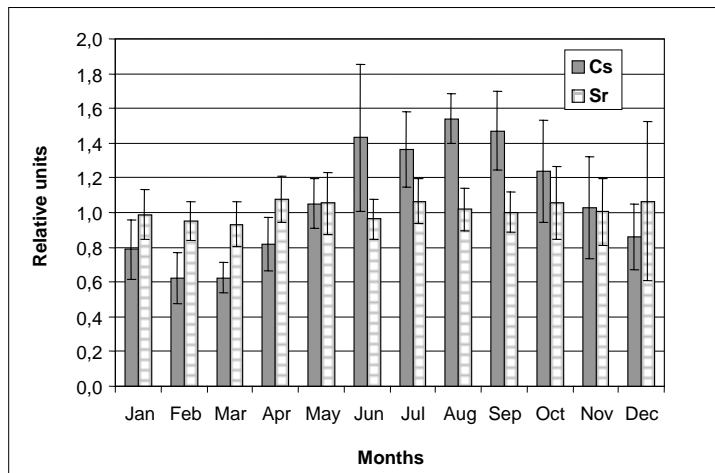

Fig. 5. Seasonal behaviour of total ¹³⁷Cs and ⁹⁰Sr in water of the Cooling Pond.

is observed in May and comprise about 25% of total ¹³⁷Cs in water with mean seasonal value less than 15% (Fig. 6). So, the ¹³⁷Cs fraction associated with seston, being the composition of plankton organisms, organic detritus and mineral particles, does not exceed 25% of total ¹³⁷Cs in water and could not provide seasonal deviations with a factor of 2.5. That is why the presence of seasonally dependant flux of ¹³⁷Cs from the bottom sediments is strongly supposed.

Meanwhile, the seasonal cycling of ¹³⁷Cs concentrations in water peaking in winter or summer has been reported to take place in several lakes [7-11]. In each study this phenomenon was attributed to dissolution of ¹³⁷Cs from the bottom sediments by ion exchange with ammonium ions whose elevated concentrations are observed under anoxic conditions. It was proved by field measurements and laboratory experiments that microbially produced NH₄⁺ is the most important in release of ¹³⁷Cs from sediments into lake water. Nowadays the linkage between Cs and nitrogen transfer, which is mediated by microorganisms, is considered to be a rather general phenomenon in freshwater systems rich in organic matter [11]. In order to clarify the real mechanism about the ¹³⁷Cs seasonal cycling in water of the Cooling Pond, the experiments should be planed to check the distribution of ammonium ion concentrations in water column and sediment cores.

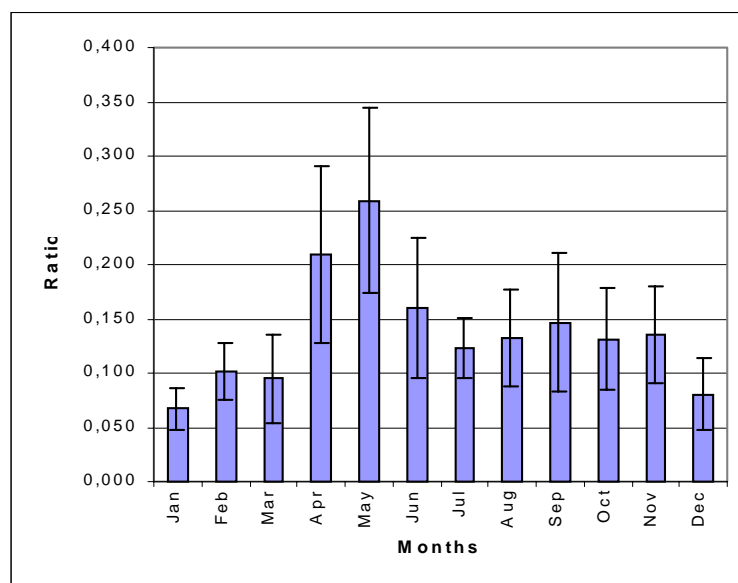

Fig. 6. Seasonal behaviour of ratio of suspended to total ¹³⁷Cs in water of the Cooling Pond.

3.2. Bottom sediments

Before the accident the last comprehensive hydrological survey of the Cooling Pond bottom sediments was performed in 1985 by the Institute of Hydrobiology [12]. Primary soils (sand loam and loam) of different stage of transformation were found to meet at water depths of 3 to 8 m and to be dominant at depths of 4-7 m. Sands of different extent of silting were met to the water depths of 12 m, and were found to be dominant at depths of less than 5 m and 6-10 m (Fig. 7). Bottom areas with depths more than 10 m were occupied by silts.

It was also found that two parts of the Cooling Pond that were sequentially turned into operation in 1976 and 1982, and were 9 and 3 years old in 1985, respectively, had different dependencies of silt layer thickness and annual sedimentation rate upon the water depth to the bottom (Fig. 8). The younger part had 1.5 times less average thickness of the silts layer and 2-3 times more sedimentation rate, being maximal of about 12 cm/year (the thickness of last-year layer of sediments) [13]. The last finding was very important for understanding of the distribution of radionuclides over bottom sediments of the Cooling Pond after the accident.

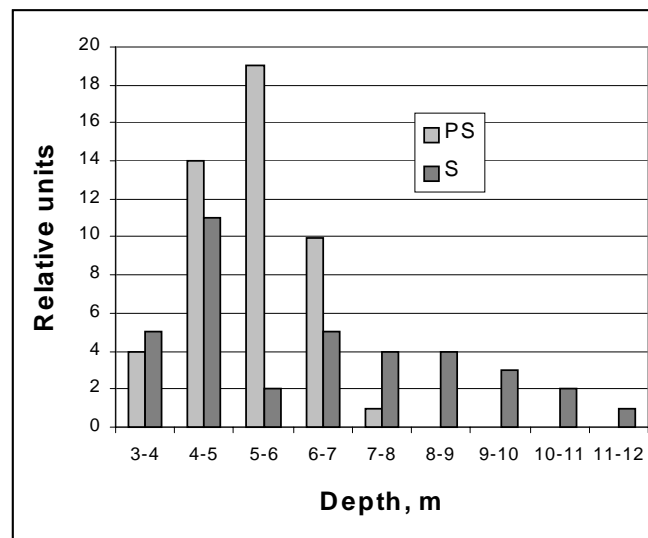

Fig. 7. Depth distribution of primary soils (PS) and sands (S) at the bottom of Cooling Pond, 1985.

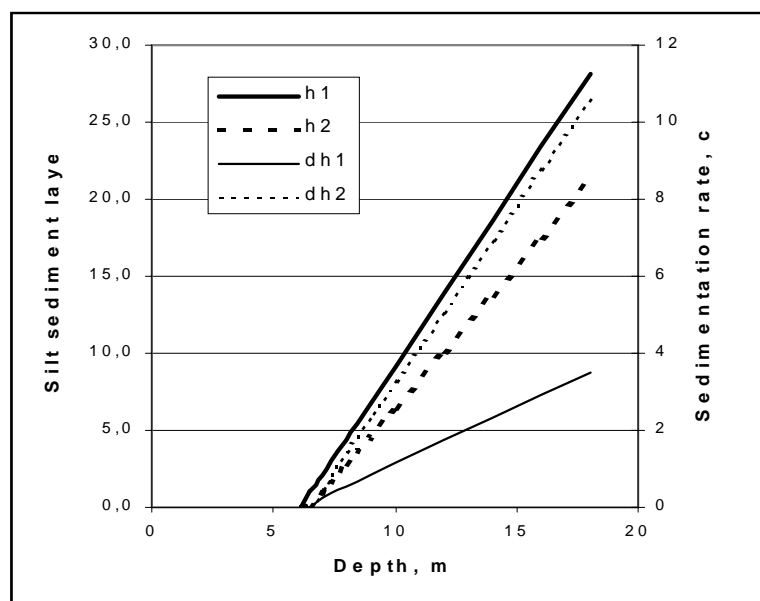

Fig. 8. Average silt sediment layer (h) and annual sedimentation rate (dh) at different depths of the first (1) and second (2) parts of the Cooling Pond [13].

Table 2. Specific activity of the top layer of deep-water sediments, kBq/kg d.w.

	^{137}Cs	^{90}Sr	$^{239,240}\text{Pu}$	^{238}Pu	^{241}Am
Average	470	41	1.4	0.67	2.0
Maximal	580	110	2.4	1.2	4.1

The bottom sediments surveys carried out in 1989, 1991, 1999 were concentrated mostly on the radiological issues and did not contribute a lot to the understanding of development of different soils distribution over the bottom of the Cooling Pond with respect to different depths.

Investigations carried out in 2001 revealed that primary soils did not degrade completely and still could be recognised by the presence of roots remains. In most cases, however, being different from the situation in 1985, wide areas of primary soils are covered by layer of silt (as a rule thin 1 – 1.5 cm, and sometimes up to 6 cm), in many cases mixed with *Dreissena* bivalve shells. Stable silt accumulation is observed at depth more than 10 m on the older part of the Cooling Pond, and at more than 11 m on the younger part.

Deep-water silt sediments present the highest specific activity of radionuclides. In the top layer of this sediment represented by recently settled materials the specific activity of all radionuclides other than ^{90}Sr varies insignificantly over the whole area (Table 2). For ^{90}Sr the difference was observed with a factor of 10.

In the areas of stable silt accumulation the density of radioactive contamination was generally found to correlate with the thickness of accumulated silt. That is why it is not surprising that the highest densities of ^{137}Cs contamination, up to 4,000 Ci/km² or 150 MBq/m², were found in the younger southern part of the Cooling Pond where higher annual sedimentation rates were observed in 1985. The most active samples of silt with ^{137}Cs specific activity of about 1.4 MBq/kg d.w. were taken also in the southern part. At water depths of 11-14 m the most contaminated layer of 1986 is covered with several tens centimeters of more recent silt sediments (Fig. 9). The most recent top layer within 5-6 cm has more contamination than the next deeper one (Fig.9) that is against the general tendency of decreasing with time of contamination level of the settling material. Taking into account the seasonal variations of ^{137}Cs concentrations in water and our considerations on the possible reasons of that, the observed picture might be explained by the presence of flux of ^{137}Cs from deeper layers of sediment to upper and then to water. In upper layers of sediment the flux of cesium meets different conditions (less anoxic, less ammonium concentrations in the interstitial water) and is being trapped by the sediment particles. These assumptions should be checked in future

**Fig. 9. ^{137}Cs specific activity in bottom sediments (silts), MBq/kg d.w.**

Table 3. Inventory of radionuclides in the bottom sediments of the Cooling Pond, after [14].

Radionuclides	Total content in the bottom sediments, Ci	Total content in the bottom sediments in a part which will remain under water, Ci
^{137}Cs	4,400	about 3,000
^{90}Sr	650	313
$^{239, 240}\text{Pu}$	14	11
^{238}Pu	7	n.e.*
^{241}Am	18	n.e.*

* - n.e. means not estimated.

investigations.

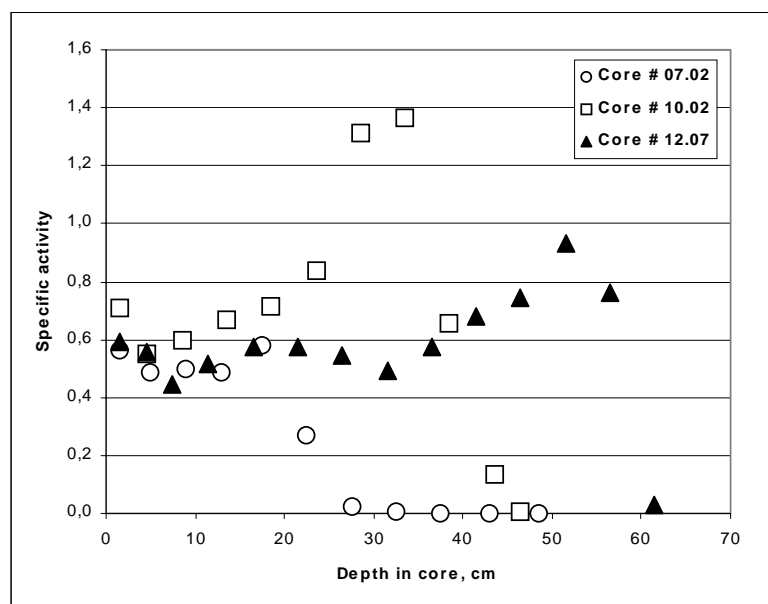
On the basis of investigations carried out in 2001 the whole inventory of radionuclides in the Cooling Pond was estimated as well as the part of area which would remain under water after the water level would had been dropped down [14]. This gave us the possibility to assess the minimal activity of radionuclides (without taking into account transsedimentation processes) that will remain under water, (Table 3).

So, after the water level in the Cooling Pond will have been dropped down to the natural elevation, about 70% of ^{137}Cs , 50% of ^{90}Sr and 80% of $^{239, 240}\text{Pu}$ will remain under water and will form the new radioecological situation in a number of water-bodies on that territory.

3.3. Biota

Fish: Average ^{137}Cs and ^{90}Sr specific activity in fish muscles is presented in Table 4. As it is seen from Table 4, the highest specific activity of caesium is observed for typical predatory species, perch and pike-perch. Some less activity is observed for omnivorous sabre carp and freshwater catfish that tend to feed also on other fish. Typical omnivorous species goldfish and lake catfish (the last being facultative predator, but in the Cooling Pond feeding upon periphyton and detritus [15]) are the next in this downward row. The lowest concentrations are found in silver bream, rudd, roach and bream which feed upon benthos and plankton organisms and vegetation. Some more concentration observed in chub, being omnivorous and facultative predator, and silver carp, which feeds upon plankton.

Almost the same row (sequence of species) was reported for ^{137}Cs specific activity in fish of the Cooling Pond in 1999 [15], the only exclusion was the highest concentration observed in freshwater catfish. It should be noticed that not only the sequence of species but also the absolute values of caesium concentrations were about the same in respective species.

On the contrary to caesium, concentration of ^{90}Sr in fish muscles is rather low, being minimal in lake

Table 4. Average ^{137}Cs and ^{90}Sr specific activity in fish muscles, August 2001, Bq/kg f.w.

Fish species	^{137}Cs	^{90}Sr
Silver bream	2,400	6.6
Rudd	2,750	10.9
Roach	3,100	4.3
Bream	3,100	-
Chub	3,850	-
Silver carp	3,900	9.5
Lake Catfish	5,100	1.7
Goldfish	5,800	5.3
Sabre carp	6,300	15.3
Freshwater Catfish	8,100	-
Pike-perch	11,800	2.3
Perch	18,100	2.7

catfish and predatory species and maximal in mainly planktotrophic species (Table 4).

Molluscs: Periphyton and benthos bivalve molluscs *Dreissena* were studied. Average ^{137}Cs concentration was about 2,600 Bq/kg f.w. with the range from 270 to 9,100 Bq/kg f.w., being the highest at the end of directing dyke, i.e. the most southern part of the habitat. Average ^{90}Sr concentration in *Dreissena* was about 760 Bq/kg f.w. with the narrower range from 610 to 1,140 Bq/kg f.w.

Plants: Macrophytes of the Cooling Pond have rather wide ranges of ^{137}Cs and ^{90}Sr contamination. For each species the ratio of maximal to minimal observed concentration was usually of about 5 to 10 and in some cases up to 80. The narrowest range and respectively the most definite values of ^{137}Cs and ^{90}Sr specific activity were observed for filamentous algae and *Potamogeton pectinatus*. The highest concentration of ^{137}Cs was observed in *Ceratophyllum demersum* - 86.6 kBq/kg d.w. and of ^{90}Sr in *Phragmites communis* - 3.9 kBq/kg (Table 5).

Submerged plants, that are filamentous algae, *Miriophyllum spicatum*, *Potamogeton pectinatus*, *Ceratophyllum demersum*, have higher levels of ^{137}Cs and ^{90}Sr contamination than semi-water ones (*Phragmites communis*).

Table 5. ^{137}Cs and ^{90}Sr in macrophytes of the Cooling Pond, August 2001, Bq/kg d.w.

Plant species	^{137}Cs		^{90}Sr	
	Range	Mean	Range	Mean
Filamentous algae	7,900 – 12,700	10,800	300 – 1,460	720
<i>Miriophyllum spicatum</i>	2,200 – 23,200	8,700	440 – 3,300	1,080
<i>Potamogeton pectinatus</i>	5,030 – 22,600	12,200	640 – 1,160	960
<i>Ceratophyllum demersum</i>	2,100 – 86,600	20,600	320 – 3,260	1,120
<i>Phragmites communis</i>	530 – 6,200	2,340	51 – 3,900	560

Seston: Seston was collected at three stations and measured for ^{137}Cs and ^{90}Sr concentrations (Table 6) and was represented mainly by phytoplankton.

Table 6. Specific activity of ^{137}Cs and ^{90}Sr in seston, August 2001, Bq/kg d.w.

Station	^{137}Cs	^{90}Sr
MOG	10,300	705
PK39	7,685	460
TPD	12,430	1,362

3.4. Dynamics of the ^{137}Cs and ^{90}Sr in the components of Cooling Pond ecosystem

The results obtained together with the previous data [6, 15] gave us the possibility to compile a table for comparison of specific activity of ^{137}Cs and ^{90}Sr in components of the Cooling Pond (Table 7). In comparison to 1995 ^{137}Cs concentration in seston in 2001 dropped down by about a factor of 10, and several times of decrease were also observed for semi-water plants and fish. Real water plants and

Table 7. Specific activity of ^{137}Cs and ^{90}Sr in components of the Cooling Pond, seston and water plants in kBq/kg d.w., molluscs and fish in kBq/kg f.w.

Ecosystem components	1991		1995		2001	
	^{137}Cs	^{90}Sr	^{137}Cs	^{90}Sr	^{137}Cs	^{90}Sr
Seston	300 – 1,000	60 - 270	20 - 140	0.1 - 1.5	7.7 - 12.4	0.7 - 1.3
Water plants	15 - 200	30 - 200				
Semi-water			3 - 25	0.1 - 0.8	0.5 - 6.2	0.05 - 3.9
Real water			8 - 93	1 - 23	2.1 - 87	0.3 - 3.3
Molluscs	1.2 - 6	10 - 25	1.2 - 3.3	2.0 - 6.5	0.3 - 9.1	0.6 - 1.1
Fish			1 - 45	-	2.4 - 18	0.0017 - 0.015

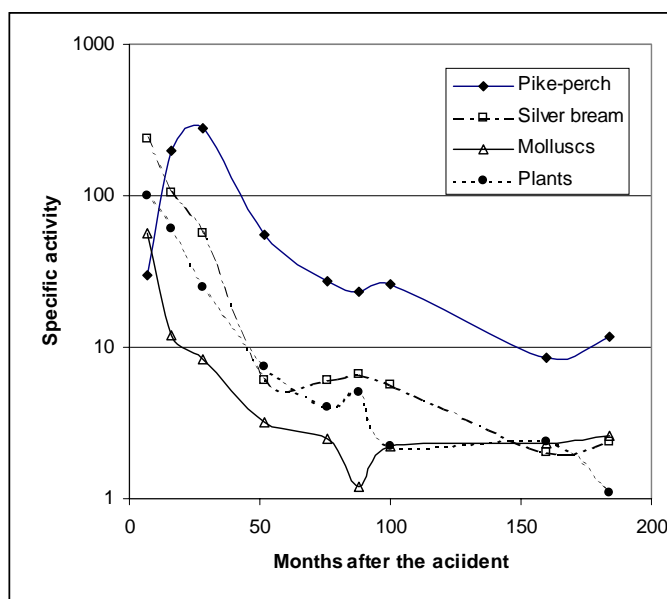

Fig. 10. The dynamics of ¹³⁷Cs specific activity in the components of Cooling Pond ecosystem, kBq/kg f.w.

molluscs demonstrated the same levels of concentrations as in 1995. As to ⁹⁰Sr, almost the same as in 1995 or higher concentrations are observed in semi-water plants and seston in 2001. Real water plants and molluscs demonstrate decreasing of ⁹⁰Sr concentration.

As it could be seen from the Fig.10, during the last 5 years contamination level of molluscs and plants remained almost the same and during the last two years the stabilisation of fish contamination is also seems to have taken place.

4. Conclusions

On the eve of decommissioning the Cooling Pond seems to enter a period of stabilisation of the radioecological situation. General trends of radioactivity reduction are being masked by the seasonal deviations in radionuclides concentration.

It is strongly supposed that seasonal cycling of ¹³⁷Cs water concentrations are caused by the seasonal dependant flux of caesium from bottom sediments into water. This supposition to be checked in special field studies on the Cooling Pond.

About 70% of ¹³⁷Cs, 50% of ⁹⁰Sr and 80% of ²⁴¹Am that are present at the moment in the Cooling Pond will remain under water after the water level will have been dropped down to the natural elevation.

References

1. Collection and Analysis of Information and Data Related to the Contamination of the Chernobyl Cooling Pond. Final Report. CEC-Contract Number: B7-5350/99/6241/MAR/C2,.GRS mbH, September 2000. 198 p.
2. Modelling and study of the mechanisms of the transfer of radioactive material from terrestrial ecosystems to and in water bodies around Chernobyl. Experimental collaboration project No 3 (ECP3). Final report. EC. Luxembourg: Office for Official publications of the European Communities, 1996 – VIII, 184 pp. EUR 16529.
3. Yegorov Yu.A., Kazakov S.V., Leonov S.V., Staurin N.V. //Radiation state of the Cooling Pond of ChNPP in May 1986. //Chernobyl'88. Reports of the 1st All-Union Scientific-Technical Conference on Overall Results of Elimination of the Consequences of Chernobyl NPP Accident. :Chernobyl, 1989. Vol. 6, P. 76-84. (Rus).
4. Rovinsky F., Iokhelson S., Yushkan E. Methods of the analysis of the environment. Moscow. Atomizdat, 1978. – P. 105-115 (Rus).
5. Ermakov A.I., Malinovskiy S.V., Kashirin I.A., Tichomirov V.A., Sobolev A.I., Rybalka V.B., Serbinovich V.V / Radiostromium Measurements in Environmental Samples with Using Sorption Materials VS-15-type and Spectrometer on Basis Low-Background Liquid Scintillation Counter / Conference on Low Radioactivity

- Measurement Techniques, 18-22nd October 1999, SCK CEN, Mol, Belgium, p.70.
6. Nasvit O., Klenus V., Fomovsky M. The radionuclides content in the hydrobionts of the water-bodies of the exclusion zone. In: Radioecology of water objects of the zone of the Chernobyl NPP accident influence. V. 1. Monitoring of radioactive contamination of the natural waters of Ukraine (review of the studies, performed in 1986-1996), Chernobylinterinform. Kyiv, 1997. P. 215-222 (Rus).
 7. Linder G., Greiner I., Grom R., Kaminski S., Kleiner J., Kulikov A., Pfeiffer W., Robbins J.A., Seewald O., Smirnova O., Wilhelm Ch., 1992. Transport of Chernobyl radionuclides in freshwater lakes. Proc. Eighth World Congress of the International Radiation Protection Association, Montreal, pp. 1693-1696.
 8. Linder G., Kaminski S., Greiner I., Wunderer M., Behrschmidt J., Schroder G., Kres S., 1993. Interaction of dissolved radionuclides with organic matter in prealpine freshwater lakes. Verh. Internat. Verein. Limnol.,25: 238-241.
 9. Evans D.W., Alberts J.J., Clark R.A., 1983 Reversible ion-exchange fixation of cesium-137 leading to mobilization from reservoir sediments. Geochim. Cosmochim. Acta, 47: 1041-1049.
 10. Comans R.N.J., Middelburg J.J., Zonderhuis J., Woittiez J.R.W., De Lange G., Das H.A., Van der Weijden C.H., 1989. Mobilization of radiocesium in pore water of lake sediments. Nature, 339: 367-369.
 11. Kaminski S., Richter T., Walser M., Linder G., Schink B., 1997. Microbially mediated redissolution of cesium radionuclides from the sediment of a shallow eutrophic lake // Freshwater and estuarine radioecology. Proceedings of an International Seminar, Lisbon, Portugal, 21-25 March 1994. Elsevier, 1997. P. 141-150.
 12. Study of the radiosensitivity and role of the hydrobionts in distribution and migration of radionuclides in the Cooling Pond of Chernobyl NPP and Kiev reservoir.: Final report IHB ASci.UkrSSR on research project № 34. V.1. Kiev, 1985 (Rus.).
 13. Hydrobiology of the cooling ponds of thermal and nuclear power plants of Ukraine / Protasov A.A., Sergeeva O.A., Kosheleva S.I. and others; Ac. Sci. UkrSSR. Institute of Hydrobiology.- Kyiv: Naukova dumka, 1991.- 192 p. (Rus).
 14. Experimental studies and assessment of the present state of Chernobyl Cooling Pond bottom topography and bottom sediment radioactive contamination. Final report. Task 1. Contract C647/D0426 of 01.02.2001. Center for Monitoring Studies and Environmental Technologies "ECOMONITOR" Ltd., Kyiv 2002, 48 p.
 15. Zarubin O.L., Shatrova N.E., Zalisskiy O.O., Derevets V.V., Nazarov A.B. Present radioecological state of the Cooling Pond of ChNPP. / Collection of Scientific Papers of the Institute of Nuclear Researches, #2 (4), 2001.- P. 133-138 (Rus).

Iodine-131 Contamination, Thyroid Doses and Thyroid Cancer in the Contaminated Areas of Russia

Valery F. STEPANENKO, Evgeny M. PARSHKOV, Viktor A. SOKOLOV, Mark Yu. ORLOV, Alexander I. IVANNKOV, Valery G. SKVORTSOV, Elena K. IASKOVA, Timofey V. KOLIZHENKOV, Irina G. KRYUKOVA, Anatoly F. TSYB

Medical Radiological Research Center, Russian Academy of Medical Sciences, Korolev Str., 4, 249020, Obninsk, Russia: valeri@obninsk.com

Abstract

About 1,800 PBq of I-131 was deposited in the environment as a result of the Chernobyl accident. The most contaminated territories in Russia are located in Bryansk, Tula, Orel and Kaluga regions. About 80% of total I-131 deposition was formed during the first week after the accident. Direct measurements of deposition densities of I-131 were very limited as far as this radionuclide decayed very fast (with half time about 8 days). In contrast, Cs-137, which is long-lived radionuclide, was investigated much more extensive. As a result all available information about the ratio of I-131 to Cs-137 has been used to estimate deposition densities of I-131 for the purpose of thyroid dose estimation. The results of direct measurements of radioactive iodine content in human thyroid gland together with the available data on I-131 and caesium-137 contamination of the soil were used for development of semi-empirical model for reconstruction of thyroid absorbed doses in cases when the measurements were not performed in 1986.

According to the estimations, which are based on the results of direct measurements of I-131 activity in thyroid (Kaluga and Bryansk regions), the median of individual thyroid dose values in Kaluga region (7 districts) varies from 30 mGy for children to 8 mGy for adults. In Bryansk region (5 districts) the median dose values for adults are in the range from 140 mGy to 30 mGy. Collective thyroid doses over the territories where the density of Cs-137 soil contamination exceeded 3.7 kBq/m² (0.1 Ci/km²) in the most contaminated 4 regions were estimated to be 72,600, 16,900, 13,400 and 3,400 person-Gy for Bryansk, Orel, Tula and Kaluga regions, respectively.

The data on annual thyroid cancer morbidity over 1986-2000 years in residents of the most affected Bryansk region, aged 0-50 years at the moment of the accident, is also presented. During the first five years after the accident (1986-1990) annual thyroid cancer morbidity in different age groups (0-4 years, 5-9, 10-14, etc.) remained at quite stable levels. Since 1991 a stable increase of the number of thyroid cancer in all age groups of the studied population has started. The semi-empirical model was applied to reconstruct individual thyroid dose for 26 thyroid cancer cases (0 - 18 years old at the moment of the accident) in the most contaminated 4 districts of Bryansk region. The tendency of dose dependence of thyroid cancer incidence was found.

IODINE-131 CONTAMINATION

In total about 1,800 PBq of I-131 was deposited in the environment as a result of the Chernobyl accident [1]. The most contaminated territories in Russia are located in Bryansk, Tula, Orel and Kaluga regions [2] (see Table 1).

Data on the radionuclide composition of fallout and atmospheric aerosol samples have been obtained by the Institute of Experimental Meteorology (SPA "TYPHOON" now, Obninsk, Russia) [2]. The first soil samples near the Chernobyl NPP were collected on 30.04.86. The fallout and atmospheric aerosol samples have been taken beginning on 27.04.86. The principal measurements of the isotopic composition of environmental samples have been performed after 10.05.86. The basic body of soil samples, for which

Table 1. Population residing in the contaminated regions following the Chernobyl accident (Russia, 1991.01.01).

N	Regions	Cs-137 soil contamination: 37-185 kBq/m ² (1-5 Ci/km ²)		Cs-137 soil contamination: 185-555 kBq/m ² (5-15 Ci/km ²)		Cs-137 soil contamination: >555 kBq/m ² (>15 Ci/km ²)		Subtotal	
		No of settlem.	Popu-lation	No of settlem.	Popu-lation	No of settlem.	Popu-lation	No of settlem	Popu-lation
1	Belgorod	56	1940					56	1940
2	Bryansk	829	227220	288	147361	275	93100	1392	467681
3	Voronezh	35	11940					35	11940
4	Kaluga	289	78078	135	15492			424	93570
5	Kursk	230	134189					230	134189
6	Orel	1987	326581	64	17648			2051	344229
7	St.-Petersburg	44	19591					44	19591
8	Lipetsk	149	38882					149	38882
9	Ryasan	646	182000					646	182000
10	Tambov	22	3569					22	3569
11	Tula	1736	768773	311	166776			2047	935549
12	Ul'yanovsk		9000						9000
13	Penza		51000						51000
14	Smolensk		10000						10000
15	Mordoviya		20000						20000
	Total		1882763	798	347277	275	93100	7096	2323140

the isotopic composition is known, was collected and measured in the second half of 1986 and during 1987, i.e. when iodine-131 activity was already negligible. As a result, direct measurements of environmental iodine-131 are very scarce now.

To get detailed information on soil and atmospheric contamination by I-131 in the first period after the Chernobyl accident, all available data were used on the isotopic composition of soil (43 points), fallout (14 points) and atmospheric aerosol samples (7 points) [3]. To verify the validity of estimating the isotopic composition of soil, fallout and aerosol samples, the ¹³⁴Cs/¹³⁷Cs activity ratios were determined simultaneously with ¹³¹I/¹³⁷Cs activity ratios. The accuracy of the ratios for soil samples was estimated as 15-25%, for the fallout - as 20-30% and for aerosol - 30-50%. The ¹³⁴Cs/¹³⁷Cs ratio averaged for the reactor core during the Chernobyl accident is known to be 0.53 with a high accuracy of SD=0.02.

From the very beginning when plotting the fields of soil I-131 contamination, it was attempted to connect this contamination with the density of soil contamination by Cs-137 (having a relatively long half-life, T_{1/2} = 30.2 years) for which the measurement data are maximum available. However, such a description may be accepted only for rough estimates of I-131 activity. In fact, there were notable differences in the radionuclide composition of contamination due to the peculiarities of transfer of radioactivity and to the variations of transfer directions in the atmosphere: the I-131 to Cs-137 activity ratios did not exceed a value of 15 in Russia (from 4.4 to 15, at 1st of May 1986), whereas in some territories of Belarussia these ratios were remarkable greater – from 5 to 42 on 1 of May 1986 [1,2]. Therefore, even if Cs-137 contamination levels were equal, the values of iodine radioisotopes intake could be different for various regions.

To reconstruct the trajectories of radionuclide transfer in the first period after the accident, the data were collected on wind velocity and direction at various heights above the sea level for the European territory of the former USSR (ETU) and also precipitation data were collected between 23^o-38^o E and 46^o-56^o N from the end of April to late May 1986 [3].

Using the trajectories analyses, the time of particle arrival to a given site, district or region for each height level was estimated [2]: the earliest time of arrival and the latest time of leaving of air particles were determined for a given site or region (Tables 2-4) This time was considered as a probable period during which a given territory was radioactively contaminated.

Table 2. Data on air particles transfer trajectories in Bryansk region (Russia).

N	Settlements	Trajectory departure from Chernobyl - 27 - 29 April 1986									
		1		2		3	4	5		6	7
1	Bryansk	-	-	-	-	-	-	17/28	19/28	06/27	22.7
2	Dubrovka	-	-	-	-	-	-	21/28	00/29	03/27	no *
3	Dyatkovko	-	-	-	-	-	-	00/29	03/29	06/27	no *
4	Zhukovka	-	-	-	-	-	-	20/28	21/28	06/27	no
5	Kletnya	-	-	-	-	-	-	18/28	19/28	06/27	-
6	Zhiryatino	-	-	-	-	-	-	17/28	19/28	07/27	-
7	Karachev	-	-	-	-	-	-	17/28	19/28	09/27	1.3
8	Trubchevsk	-	-	-	-	-	-	23/29	01/30	03/27	4.0
9	Navlya	-	-	-	-	-	-	14/28	16/28	09/27	no
10	Pochep	-	-	-	-	-	-	20/29	22/29	03/27	no
		-	-	-	-	-	-	12/28	14/28	09/27	5.7
11	Fokino	-	-	-	-	-	-	19/28	21/28	07/27	22.7
12	Komarichi	14/28	0.2	16/29	0.7	08/27	-	14/28	15/28	08/27	-
		04/29	0.7	06/29	0.7	08/28	-	-	-	-	-
13	Suzemka	11/29	0.7	13/29	0.7	03/29	-	-	-	-	-
		05/29	0.7	07/29	0.7	21/28	-	-	-	-	-
		-	-	-	-	-	-	10/29	11/29	00/29	-
14	Klintsy	-	-	-	-	-	-	12/28	13/28	09/27	no *
15	Starodub	-	-	-	-	-	-	11/28	13/28	09/27	no
16	Krasnaya Gora	-	-	-	-	-	-	14/28	15/28	07/27	no
17	Mglin	-	-	-	-	-	-	17/29	21/29	03/27	no *
18	Sevsk	12/29	0.7	13/29	0.7	10/27	no	-	-	-	-
		04/29	0.7	05/29	0.7	18/28	no	-	-	-	-
		11/29	0.7	16/29	0.2	03/29	0.5	12/29	16/29	00/29	0.5
19	Lokot	-	-	-	-	-	-	14/28	15/28	11/27	-
20	Surazh	-	-	-	-	-	-	16/29	20/29	03/27	no
21	Unecha	-	-	-	-	-	-	14/28	15/28	08/27	no
		-	-	-	-	-	-	18/28	21/29	03/28	no
22	Vigonichi	-	-	-	-	-	-	16/28	17/28	08/27	-

Explanation for columns 1-7:

- 1 - earliest date of the trajectory arrival, hour/day (hh/dd) and trajectory height above the sea level, km;
- 2 - latest date of the trajectory departure, hour/day (hh/dd) and trajectory height above the sea level, km;
- 3 - date of the air particles trajectory departure from the Chernobyl reactor, hour/day (hh/dd);
- 4 - precipitation, mm/day (no - no precipitation, * - data related to the nearest settlement);
- 5 - earliest date of the trajectory arrival at the height 0.45 km above the sea level, hour/day (hh/dd) and latest date of this trajectory departure, hour/day (hh/dd);
- 6 - date of the 0.45 km air particles trajectory departure from the Chernobyl reactor, hour/day (hh/dd);
- 7 - precipitation, mm/day (no - no precipitation, * - data related to the nearest settlement);

Table 3. Data on air particles transfer trajectories in Tula region (Russia).

N	Settlements	Trajectory departure from Chernobyl - 27 - 28 April 1986									
		1		2		3	4	5		6	7
1	Efremov	-	-	-	-	-	-	01/29	02/29	19/27	no
2	Novomoskovsk	-	-	-	-	-	-	06/29	09/29	08/27	1.7 *
3	Uzlovaya	-	-	-	-	-	-	03/29	05/29	09/27	1.7
4	Bogoroditsk	-	-	-	-	-	-	02/29	04/29	10/27	no
5	Klimovsk	-	-	-	-	-	-	05/29	07/29	06/27	1.7 *
6	Kurkino	02/29	0.2	11/29	0.7	18/27	no *	02/29	04/29	18/27	no *
	Kurkino	17/29	0.2	17/29	0.2	18/28	no *	-	-	-	-
7	Epifan	05/29	0.2	10/29	0.7	12/27	-	-	-	-	-
	Epifan	08/29	0.7	10/29	0.7	00/28	-	-	-	-	-
8	Volovo	01/29	0.2	09/29	0.7	15/27	no	01/29	02/29	15/27	no
	Volovo	08/29	0.2	09/29	0.7	15/28	no	-	-	-	-
9	Chern	-	-	-	-	-	-	22/28	23/28	12/27	1.6
10	Plavsk	-	-	-	-	-	-	01/29	03/29	09/27	0.3
11	Schekino	-	-	-	-	-	-	07/29	08/29	06/27	no *
12	Kireevsk	-	-	-	-	-	-	03/29	06/29	09/27	no *
13	Arkhangelskoye	23/28	0.2	14/29	0.7	18/27	-	23/28	01/29	18/27	-
	Arkhangelskoye	13/29	0.7	14/29	0.7	18/29	-	-	-	-	-

Explanations for columns 1-7 are shown in Table 2.

Table 4. Data on air particles transfer trajectories in Kaluga region (Russia).

N	Settlements	Trajectory departure from Chernobyl - 27- 28 April 1986						
		1	2	3	4	5	6	7
1	Lyudinovo	-	-	-	-	02/29 04/29	06/27	no*
2	Zhizdra	-	-	-	-	23/28 01/29	06/27	no
3	Duminichi	-	-	-	-	23/28 01/29	06/27	no*
4	Khvastovichi	-	-	-	-	20/28 22/28	06/27	0.7*
5	Ul'yanovo	-	-	-	-	03/29 06/29	06/27	no*

Explanations for columns 1-7 are shown in Table 2.

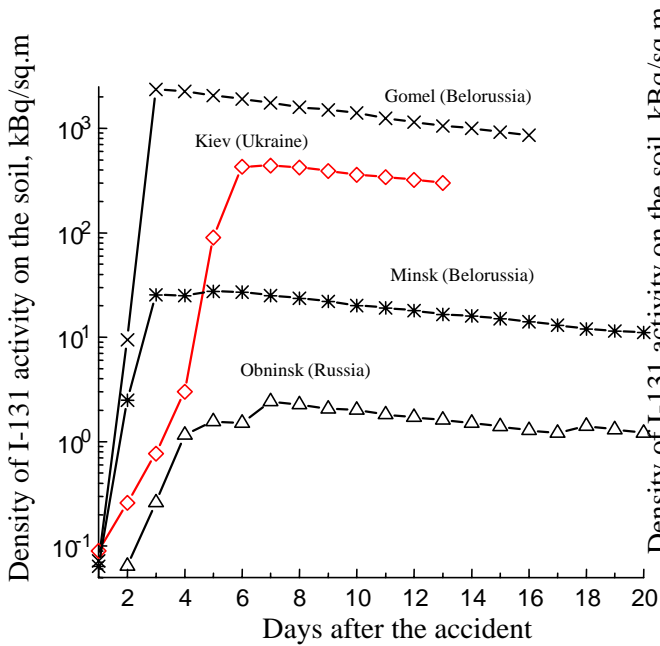

Fig. 1. Accumulation of I-131 activity in soil.

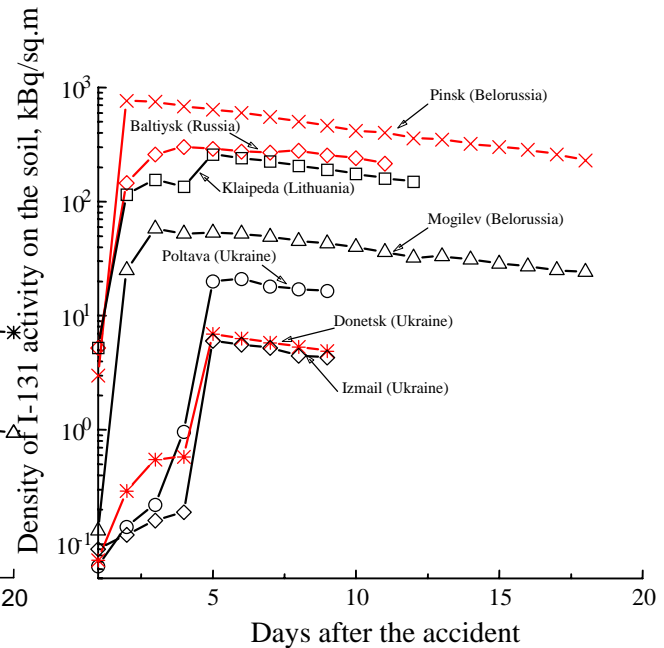

Fig. 2. Accumulation of I-131 activity in soil.

As noted above, the data on the results of direct measurements of radioactive iodine isotopes in the environment after the Chernobyl accident are scarce: for example the time dependences of I-131 fallout are known only for a few location over all territory of FSU [2-5]. The time integration of such kind of dependencies show that a major part (more than 80-90 %) of I-131 contamination was accumulated in studied territories by the moment D + 5 days (Fig.1,2). These data are confirmed by analyzing the dose rate dependence on time at some settlements. For example, in Novozybkov (Bryansk region, Russia) as well as in Chernobyl (Ukraine), Pinsk (Belorussia) and Semenovka (Ukraine), the dose rate trend on time shows that a dose rate had increased only during the radioactive cloud passage, i.e. prior to D+5[2,4]. After the cloud passage the dose rate had rapidly decreased.

Despite the shortage of the available data with the results of I-131 measurements, this information is very valuable because the knowledge of I-131/Cs-137 ratios and time parameters of fallout are very important for thyroid dose estimations.

THYROID DOSES

Intake of radioactive iodine isotopes, mainly I-131 in milk, was the main source of thyroid irradiation of population in contaminated settlements. The results of direct measurements of radioactive iodine content in human thyroid gland in Byelorussia together with available data on I-131 and Cs-137 contamination of the soil were used for development of semi-empirical model for reconstruction of thyroid absorbed doses in cases when the measurements were not performed in 1986 [2]. For validation and tuning of this model in Russian territories about 30,000 direct measurements of radioactive iodine content

in human thyroid gland in Kaluga and Bryansk regions (Russia) [6] and all available data on I-131 and Cs-137 contamination of the soil [4,5] were used.

Dose estimation by semi-empirical model

Mean dose values in exposed population of each contaminated settlement over Russia where the density of Cs-137 soil contamination exceeded 3.7 kBq/m^2 (0.1 Ci/km^2) were evaluated using the model. Collective doses for contaminated “spots” in 4 most contaminated Russian regions were estimated as the following [2]: 72,600 person-Gy for Bryansk region (in population of 1,137,100 persons), 16,900 person-Gy for Orel region (in population of 448,000 persons), 13,400 person-Gy for Tula region (in population of 1,310,000 persons) and 3,400 person-Gy in Kaluga region (in population of 213,500 persons) (see Table 5 and Table 6).

Dose estimation based on direct measurement data

According to the estimations (Table 7), which are based on the results of direct measurements of I-131 activity in thyroid gland in the inhabitants of the contaminated district in Kaluga and Bryansk regions [6], the median of individual thyroid dose values in Kaluga region (7 districts) varies from 30 mGy for children to 8 mGy for adults (geometric standard deviation of about 2.6). As seen in Table 8, in Bryansk region (5 districts) the median dose values for adults are in the range from 140 mGy to 30 mGy (geometric standard deviation of about 2.7).

THYROID CANCER

Annual thyroid cancer morbidity over 1986-2000 years in residents of the most affected Bryansk region, aged 0-50 years at the moment of the accident, is presented in Table 9-11.

All thyroid cancer cases (in total 1201 cases) in patients aged 0–50 years at the period of iodine radionuclides action (May-June 1986), which were registered in the Bryansk Regional oncological registry, were taken as the basic material for analysis. Age limit in 50 years is explained mainly by low life span of Russian population (around 70 years for females and 60 for males). We believe, that the used age period (0–50 years at the moment of the accident and correspondingly 0–65 years at the moment of diagnosis) is large enough for elucidation of the general features of the post-Chernobyl thyroid cancer situation. Annual thyroid cancer morbidity was followed up in this cohort of population since 1986 to 2000 and summarized over 5-year periods (1986-1990, 1991-1995, 1996-2000) in different age groups (0-4 years, 5-9, 10-14, etc.). Such division permitted to form comparable subgroups for both sex and age over all period of surveillance.

Average number of Bryansk region population in the age cohort 0-50 years at the moment of the accident (and correspondingly in the next 5-year periods) comprised approximately 1 million and in each age group around 100,000 (Table 9). Only in the age group 40-44 year (period 1986-1990), which corresponds to 45-49 year (period 1991-1995) and 50-54 year (period 1996-2000), there is a demographic fall as a consequence of the World War II. It should be noted that the number of the total examined cohort as well as the numbers of population in individual subgroups did not markedly change during the analyzing period. This permitted to carry out a correct analysis of thyroid cancer morbidity in age groups.

Table 10 demonstrates annual distribution of thyroid cancer cases in patients aged 0-50 at the moment of the accident (Bryansk cohort, 0-64 years old at diagnosis, both sexes). Table 11 presents thyroid cancer incidence rate in the same cohort averaged over five years periods after the accident.

Table 10 and Table 11 demonstrate that during the first five years after the accident (1986-1990) annual thyroid cancer morbidity in different age groups (0-4 years, 5-9, 10-14, etc.) remained at quite stable levels. Since 1991 a stable increase of the number of thyroid cancers in all age groups of the studied population has started. It seems to be that the minimal duration of the latent period of radiogenic thyroid

Table 5. Thyroid doses : Bryansk and Tula regions, Russia.

Cs-137 soil contaminat. density, kBq/m ²	Population, (×10 ³ pers.)	Average Cs-137 soil contaminat. density, kBq/m ²	Average thyroid dose in population, mGy *	Collective dose in population, (×10 ³ person-Gy) *
BRYANSK				
3.7- 37	670	12.6	9.5	6.39
37 - 185	227	86.6	58.9	13.4
185 - 555	147	336	176	25.9
>555	93.1	918	289	26.9
Total	1137.1		64	72.6
TULA				
3.7- 37	370	24.4	4.43	1.64
37 - 185	770	112	11.2	8.64
185 - 555	170	281	18.3	3.11
Total	1310		10.2	13.39

* - Taking into account the real beginning of the pasture period.

Table 6. Thyroid doses: Kaluga and Orel regions, Russia.

Cs-137 soil contaminat. density, kBq/m ²	Population, (×10 ³ pers.)	Average Cs-137 soil contaminat. density, kBq/m ²	Average thyroid dose in population, mGy *)	Collective dose in population, (×10 ³ person-Gy) *
KALUGA				
3.7- 37	120	20.3	9.50	1.14
37 - 185	78	98.4	21.9	1.71
185 - 555	15.5	263	35.5	0.55
Total	213.5		15.9	3.40
OREL				
3.7- 37	100	23.3	17.3	1.73
37 - 185	330	90.3	42.0	13.85
185 - 555	18	220	72.7	1.31
Total	448		37.7	16.9

* - Taking into account the real beginning of the pasture period.

Table 7. Estimated parameters of individual thyroid dose distribution (7 investigated districts of Kaluga region).

Items ^a	Groups by age at the time of the accident ^b					
	-1	1-2	2-7	7-12	12-17	17-
N	1075	989	7491	6440	4997	5732
MID(mGy)	550	530	460	320	250	250
DA (mGy)	52	43	23	15	14	13
SD (mGy)	58	52	29	17	17	15
DM (mGy)	31	26	14	10	8.3	8.1
GSD	2.7	2.7	2.6	2.4	2.7	2.7

^a: N=number of persons with the results of direct measurements in given age range; MID=maximum individual dose; DA=arithmetic mean dose; SD=standard deviation; DM=median dose; GSD=geometric standard deviation.

^b:Include the left end while exclude the right end.

Table 8. Estimated parameters of individual thyroid dose distribution (five investigated districts of Bryansk region).

District	Arithmetic mean dose (mGy)	Median dose (mGy) ^a	Number of adults
Gordevskiy	120	74	75
Klimovskiy	48	31	9
Klintsovskiy	62	41	10
Krasnogorskiy	223	143	93
Novozybkovskiy	46	30	83

^aGeometric standard deviation is 2.7.

Table 9. Average size of cohort and number of persons in different age groups in 5-year periods.

(Bryansk cohort, 0-50 years old at the moment of the accident, both sexes)

Years	Number of population in different age groups (persons)												
	Total number of population in cohort	0 – 4	5 – 9	10 – 14	15 – 19	20 – 24	25 – 29	30 – 34	35 – 39	40 – 44	45 – 49	50-54	55-59
1986-1990	988315.4	110431.8	103914.4	100992.8	95863.8	94283.0	114403.4	115018.0	102798.2	64859.2	85750.8	+	+
1991-1995	974626.8	-	111004.4	104406.8	98640.4	88211.2	95248.8	116310.2	113623.8	100113.4	59952.8	87115.0	+
1996-2000	982553.7	-	-	114588.0	104153.3	96770.0	89934.3	102560.0	121572.0	111663.7	96125.0	51610.3	93577.0

Notes: 1. Sign (-) means the shift-out of cohort after 5-year periods.

2. Sign (+) means that age groups 0-49 analyzed in period 1986-1990 entered in the age groups 5-54 in period 1991-1995 and the age groups 10-59 in period 1996-2000.

Table 11. Thyroid cancer incidence rate at diagnosis in persons aged 0–50 years at the moment of the Chernobyl accident averaged over 5 years periods after the accident. (Bryansk cohort, both sexes, per 100 000 of population)

Year of diagnosis	Number of thyroid cancer cases in different age groups												
	0-4	5-9	10-14	15-19	20-24	25-29	30-34	35-39	40-44	45-49	50-54	55-59	60-64
1986-1990	0	0	1.9	2.1	6.4	15.7	26.1	35.0	37.0	29.2	27.3	+	+
1991-1995	-	6.5	14.6	17.5	21.9	27.7	35.4	58.2	70.3	74.1	57.2	49.7	+
1996-2000	-	-	19.2	30.6	28.1	35.6	37.5	70.6	87.8	133.3	116.8	74.7	63.0

Notes:

Sign (-) means the absence of patients in the corresponding age groups owing to their natural shift in elder age groups.

Sign (+) means the absence of patients in the corresponding age groups owing to restriction of the analyzing cohort by the of age 50 years old at the moment of the accident.

Table 10. Annual distribution of thyroid cancer cases in patients aged 0-50 at the moment of accident.

(Bryansk cohort, 0-64 years old at the moment of diagnosis, both sexes)

Year of diagnosis	Number of thyroid cancer cases in different age groups															
	0-4	5-9	10-14	15-19	20-24	Sub total 0-24	25-29	30-34	35-39	40-44	45-49	Sub total 25-49	50-54	55-59	60-64	Total 0-64
1986	0	0	0	0	1	1	4	5	4	1	2	16	4	+	+	21
1987	0	0	1	1	1	3	4	5	6	5	7	27	2	+	+	32
1988	0	0	0	0	1	1	5	5	10	5	4	29	7	+	+	37
1989	0	0	0	0	3	3	3	10	7	6	6	32	6	+	+	41
1990	0	0	1	1	0	2	2	5	9	7	6	29	7	+	+	38
Sub total 1986-1990	0	0	2	2	6	10	18	30	36	24	25	133	26	+	+	169
1991	-	1	0	2	1	4	8	6	8	7	5	34	13	+	+	51
1992	-	3	0	0	4	7	3	8	7	16	6	40	12	3	+	62
1993	-	1	0	5	3	9	6	10	15	11	11	53	8	13	+	83
1994	-	2	7	7	5	21	4	7	18	7	16	52	12	10	+	95
1995	-	-	8	3	7	18	8	10	15	17	16	66	6	14	+	104
Sub total 1991-1995	-	7	15	17	20	59	29	41	63	58	54	245	51	40	+	395
1996	-	-	3	3	2	8	5	5	6	14	14	44	7	16	3	78
1997	-	-	7	3	6	16	5	8	17	15	18	63	8	10	12	109
1998	-	-	7	5	2	14	4	4	17	13	17	55	9	11	8	97
1999	-	-	2	10	8	20	9	13	14	22	29	87	28	20	15	170
2000	-	-	2	10	8	20	10	11	29	29	26	105	29	8	21	183
Sub total 1996-2000	-	-	21	31	26	78	33	41	83	93	104	354	81	65	59	637
Total 1986-2000	0	7	38	50	52	147	80	112	182	175	183	732	158	105	59	1201

Notes:

1. In shaded lines and columns the summarized data over time intervals and age groups are presented.
2. Sign (-) means the absence of patients in the corresponding age groups owing to their natural shift in elder age groups.
3. Sign (+) means the absence of patients in the corresponding age groups owing to restriction of the analyzing cohort under 50 years old at the moment of the accident.

cancer is equal about 5 years. After that we can see the rise of thyroid cancer morbidity in all age groups due to possible influence of the Chernobyl accident.

One of the key questions regarding the radiogenic nature of thyroid cancer following the Chernobyl accident was focused on its dose dependence of the thyroid cancer incidence. There was an attempt to investigate this question using the available individual data for 26 thyroid cancer cases in Bryansk region.

The retrospective individual dose estimations were performed for 26 thyroid cancer cases (17 female and 9 male cases in the age 0-18 years old at the moment of accident) [7] which had been registered before the end of 1997 in Novozybkovsky, Krasnogorsky, Klintsovsky and Klimovsky districts – the four of the most contaminated territories of Bryansk region. The verification of diagnosis in 18 cases was performed by a group of experts at an international level: Prof. D. Williams (Cambridge, UK), Prof. E. Lushnikov (Obninsk, Russia), Prof. G. Frank (Moscow), Dr A. Abrosimov (Obninsk). Other cases were diagnosed and operated in Children Oncology Research Institute of Oncological Scientific Centre (Moscow).

A special questionnaire was used to gather data for individual thyroid dose reconstruction, including information about milk consumption, leafy vegetable consumption, and use of thyroid blocking agents. Individual doses were retrospectively estimated using semi-empirical model [2]. In Table 12 the reconstructed individual thyroid doses are presented for different dose ranges: < 0.25 Gy, $0.25 \text{ Gy} \leq 0.5$ Gy, $0.5 \text{ Gy} \leq 0.75$ Gy, $0.75 \text{ Gy} \leq 1.0$ Gy and ≥ 1.0 Gy.

The results of analysis of available individual dose estimates based on thyroid counting to determine I-131 content in May-June 1986 were applied in order to estimate the numbers of young population related to various individual dose ranges [6]. Then, the numbers of thyroid cancer cases corresponding to the different individual dose ranges were referred to the young population of the same dose ranges (Table 12).

The “background” level of thyroid cancers for the investigated population during 11.7 years after the accident was taken into account. For calculation of the background level the statistical data of [8] were used. The results of dose dependence estimation are presented in Table 12 and in Figure 3.

CONCLUSIONS

- The most contaminated territories in Russia following the Chernobyl accident are located in Bryansk, Tula, Orel and Kaluga regions. According to the trajectory analysis of the radioactive plumes from Chernobyl, the main part (more than 80-90 %) of I-131 contamination in these regions was formed by the five days after the accident. There were notable differences in the radionuclide composition of contamination due to the peculiarities of transfer of radioactivity and to the variations transfer directions in atmosphere: the I-131 to Cs-137 activity ratios did not exceed value of 15 in Russia, whereas in the some territories of Byelorussia these ratios were remarkable greater than 15.

Table 12. Estimation of thyroid cancer incidence dose dependence for population in four contaminated districts of Bryansk region (age group < 18 years old at the moment of accident); see Figure 3 as well.

Range of individual thyroid doses, Gy	Population in the dose range, persons	Number of thyroid cancer cases in the dose range	“Background” level of thyroid cancers for the population in the dose range	Thyroid dose in cancer cases, Gy,(D)	Standard deviation of thyroid dose in cancer cases, Gy	Incidence of thyroid cancer cases in the dose range per 10^4 persons
<0.25	29316	8	1.53	0.073	0.069	2.21
$0.25 \leq 0.5$	14439	5	0.752	0.32	0.096	2.94
$0.5 \leq 0.75$	9294	6	0.484	0.67	0.043	5.93
$0.75 \leq 1.0$	2654	3	0.138	0.87	0.095	10.1
≥ 1.0	2960	4	0.154	1.25	0.27	13.0

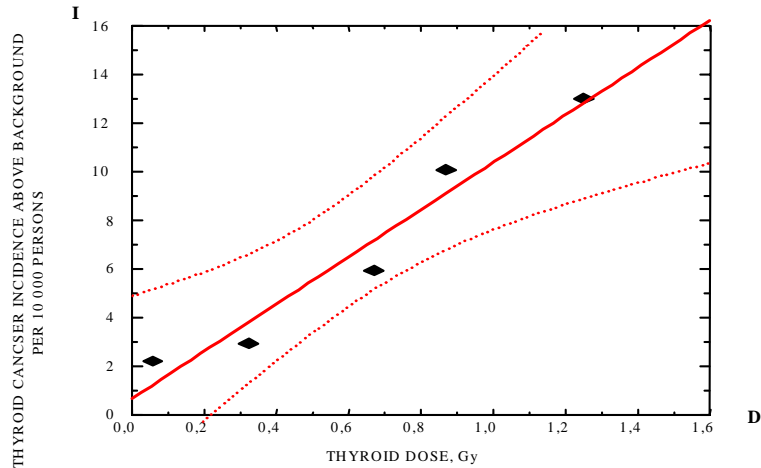

Fig. 3. THYROID CANCER INCIDENCE VS INDIVIDUAL THYROID DOSES
 four districts of Bryansk region: 26 cases from 04.1986 till 12.1997).
 Only persons of 18 years old by 04 - 05.1986.
 Upper and lower curves are 95% confidence bands.
 See Table 3 and relationship (1), (2) as well.

- The results of direct measurements of radioactive iodine content in human thyroid gland in Byelorussia as well as the available data on iodine-131 and Cs-137 contamination of the soil were used for development of semi-empirical model to reconstruct thyroid absorbed doses. For validation and tuning of this model in Russian territories about 30,000 direct measurements of radioactive iodine content in human thyroid gland in Kaluga and Bryansk regions (Russia) and all available data on I-131 and Cs-137 contamination of the soil were used.

- By using semi-empirical model mean thyroid dose values in exposed population of each contaminated settlement over Russia where the density of Cs-137 soil contamination exceeded 3.7 kBq/m^2 (0.1 Ci/km^2) were evaluated. Collective doses for contaminated “spots” in the most contaminated 4 regions were estimated as the following: 72,600 person-Gy for Bryansk region (in population of 1,137,100 persons), 16,900 person-Gy for Orel region (in population of 448,000 persons), 13,400 person-Gy for Tula region (in population of 1,310,000 persons) and 3,400 person-Gy in Kaluga region (in population of 213,500 persons).

- According to the estimations, which are based on the results of direct measurements of I-131 activity in thyroid (Kaluga and Bryansk regions), the median of individual thyroid dose values in Kaluga region (7 districts) varies from 30 mGy for children to 8 mGy for adults (geometric standard deviation of about 2.6). In Bryansk region (5 districts) the median dose values for adults are in the range from 140 mGy to 30 mGy (geometric standard deviation of about 2.7).

- The data on annual thyroid cancer morbidity over 1986-2000 years in residents of the most affected Bryansk region is presented in different age groups. During the first five years after the accident (1986-1990) annual thyroid cancer morbidity remained at quite stable levels. Since 1991 a stable increase of the number of thyroid cancers in all age groups of the studied population has started as a possible result of radiogenic influence of the accidental release of I-131 from the Chernobyl NPP.

- The semi-empirical model was applied to reconstruct individual thyroid doses for 26 thyroid cancer cases (0 - 18 years old at the moment of accident) in the most contaminated 4 districts of Bryansk region. A special questionnaire was used to gather data for individual thyroid dose reconstruction, including information about milk consumption, leafy vegetable consumption, and use of thyroid blocking agents. The incidence rate of thyroid cancer cases corresponding to the different individual dose ranges were calculated by referring the number of thyroid cancer case to the young population of the same dose ranges. The tendency of dose dependence of thyroid cancer incidence was found.

Acknowledgements

This work was supported in part by Russian Ministry of Health and by Russian Academy of Medical Sciences. This work has been supported in part by Grant N N00014-94-1-0049 issued to Georgetown University from the Office of Naval Research in support of the International Consortium for Research on the Health Effects of Radiation. The contents are solely the responsibility of the authors and do not necessarily reflect the views of the Office of Naval Research or Georgetown University. A part of this work was supported by Hiroshima University, Japan (special gratitude to Prof. M. Hoshi). Special gratitude to the Ministry of Education (Japan) and to Dr. T. Imanaka (Research Reactor Institute of Kyoto University, Japan) for the possibility to publish this paper. Authors are very grateful to Dr. P. Voilleque, MJP Risk Assessment, USA, for very useful discussion and comments to the materials and data of this paper.

References.

1. UNSCEAR 2000 Report to the General Assembly. Annex J: Exposed and Effects of the Chernobyl Accident. In: International Journal of Radiation Medicine. Special Issue. Vol. 2-4 (6-8). 2000. Kiev. P. 3-109.
2. Stepanenko V.F., Tsyb A.F., Parshkov E.M. et al. Retrospective thyroid absorbed doses estimation in Russia following the Chernobyl accident: progress and application to dosimetrical evaluation of childhood thyroid cancer morbidity. In: "Effects of low-level radiation for residents near Semipalatinsk nuclear test site". Proc. of the Second Hiroshima International Symposium, Hiroshima, July 23-25, 1996 (Edited by M. Hoshi, J. Takada, R. Kim, Y. Nitta). Hiroshima University, 1996, p. 31-84.
3. Environmental Radioactive contamination after Chernobyl NPP Accident. IEM SPA "Typhoon". Obninsk. p.305, 1986 (in Russian).
4. Orlov M.Yu., Snykov V.P., Khvalensky Yu.A. et. al. Radioactive contamination of Belorussia and Russia territories after the Chernobyl accident. *Atomnaya Energiya*. 72:4. p. 371-376, 1992 (in Russian).
5. Makhonko K.P., Kozlova E.G., Volokitin A.A. Radioiodine accumulation on soil and reconstruction of doses from iodine exposure on the territory contaminated after the Chernobyl accident. In: Radiation and risk, Bulletin of the National Radiation and Epidemiological Registry. English translation of Russian issue N7. Cambridge, MA; 1997. p. 90-142.
6. Stepanenko V.F., Gavrilin Yu.I., Khrouch V.T. et al. Re-evaluation of thyroid doses in Russia after the Chernobyl Accident. In: International Congress Series. Elsevier Science. 642 ,2001 (in press).
7. Stepanenko V., Tsyb A., Skvortsov V. et al. New results of thyroid retrospective dosimetry in Russia following the Chernobyl accident. In: "Radiation and thyroid cancer". (Eds.: G. Thomas, A. Karaoglou, E.D. Williams). World Scientific Publishing Co.Pte. Ltd. Singapore-New Jersey-London-Hong-Kong. 1999, p. 333-338.
8. Dvorin VV, Axel EA, Trapesnikov NN. The statistics of malignant neoplasms in Russia and CIS. Moscow, 1995 (in Russian).

Radioactive Contamination of Food in Stepanivka Village, Zhytomyr Region, Ukraine: in 1992 and in 2001

Volodymyr TYKHYY

*Institute of Mathematical Machines and Systems, the National Academy of Science of Ukraine
42 Glushkova str., Kyiv 187, Ukraine: eeic@gluk.org*

Abstract

Two series of measurements of radioactive contamination in food samples were performed in 1992 and in 2001 in a village contaminated by the Chernobyl accident. The village, Stepanivka is located 120 km to the west of Chernobyl NPP and has a typical level of Cs-137 surface contamination around that area (3 – 5 Ci/km²). The study was performed by the Independent Environmental Laboratory in Kyiv, jointly founded by the Ukrainian NGO "Green World", Greenpeace International and the International Renaissance Foundation.

It is shown that the Cs-137 contamination in milk in 2001 became 9 times lower than in 1992, while the Cs-137 contamination in wild mushrooms and berries remained at the same level. Annual intake of Cs-137 by the people in Stepanivka through food products and water was about 3 times lower in 2001 than in 1992. On the contrary to the trend of Cs-137, activity of Sr-90 in milk and dried berries was significantly higher in 2001 than in 1992.

1. Introductory note

The idea of the study was not merely scientific, but included also a social aspect. In 1992, general public usually did not trust "official" data on radioactive contamination because the Soviet era attempts of hiding the consequences of the Chernobyl disaster were still fresh in memory. Thus the results of an independent laboratory which was run by non-governmental organizations with strong "green" reputation would have an important social value. At that time (1991-1992), as became clear from later publications, many scientific organizations were studying radioactive contamination of food, but very few results were published yet. Of course, there were no attempts to make the results of the investigations available and understandable for general public. Only later results of investigation were presented at conferences, see, for example, [1].

The first research was undertaken in spring-summer of 1992 by the Radiological Laboratory of Greenpeace Ukraine (this laboratory was a joint project by Greenpeace International, Ukrainian NGO "Zelenyi Svit (Green world)" and the Kyiv-based International Renaissance Foundation. Part of the equipment was donated to "Green world" by two German universities).

The idea of the study included "on-site" measurements of food samples. This was very important to relieve possible feeling of insecurity in local communities. On-site measurements were possible because the laboratory possessed portable gamma-radiation monitors LB200 (manufactured by Berthold, Germany) with the low limit of Cs-137 detection in 0.5-0.8 kg samples. Indeed, the attitude of the villagers was rather negative when the investigation began: "you are just another team that will fool us". Later we managed to build their trust. The people of Stepanivka and other villages nearby were informed about the results of the 1992 study through local newspaper and at various meetings.

The second research was conducted in summer of 2001, owing to a support from the grant of the Ministry of Education of Japan. The study would reveal some changes (first of all - radioactive contamination of food) that took place in Stepanivka village during almost 10 year period.

For both studies, analyses of Cs-137 and Sr-90 were performed by the Laboratory of the Radiation

Hygiene of the Ukrainian Institute of Hygiene and Medical Ecology. Cs-137 was measured using Camberra Ge spectrometer with the lower limit of detection 0.17 Bq (for 10,000 sec measurement). Sr-90 was detected by Y-90 radiochemical method.

2. General information

Village Stepanivka is located 120 km to the west of Chernobyl NPP. In 1992, there lived 369 people, including 75 children and 108 retired people. In 2001, the population slightly decreased and became older: 45 children, 145 retired. The main enterprise in the village is a collective (in 1992 - state) farm that produces milk, potato, hops and some other crops. Most officials (director of the farm, village Council Head, radiologist, agronomist) have been working in the same positions since 1992. Villagers have cows in private sector and produce potato and vegetables in their vegetable gardens for their own consumption. In 1992, many people collected and ate mushrooms (8 families out of 25 interviewed) and berries (15 out of 25) from nearby forests. They indicated that they were eating less mushrooms and berries than before the Chernobyl accident, because they knew about radioactive contamination. Several families ate fish from the small river Zherev.

Soils in the vicinity of the village are light sour turf-podzol and grey, with pH from 4.6-5.5. Soil samples were taken on plowed fields, from the upper layer 0-20 cm (same fields in 1992 and 2001). Several samples collected in 1992 by 5 cm layers showed a uniform distribution of radioactivity. In 2001, radiation levels on sites varied between 0.06 - 0.13 $\mu\text{Sv h}^{-1}$. Radioactive contamination of soil in 1992 and 2001 is summarised in Table 1.

The results of measurement of radioactive contamination of soil are close to the data provided by the local agrochemical service (surface contamination by Cs-137 between 3 - 5 Ci/km²). Thus Stepanivka could be considered as a typical village for the areas not located directly on the so-called "Western plume of Chernobyl contamination".

Dietary habits and local food consumption were investigated in 1992. Out of 100 families, 25 were interviewed (10 of them had children). Average consumption of main locally produced food products per person is summarised in Table 3. Milk products (usually - white cheese and sour cream) were re-calculated into milk (with the assumption that milk products retain all radioactivity that was in milk). The diet (milk-based) is characteristic for this region of Ukraine [2]. In 2001, the consumption patterns were the same. Bread, other cereals, fruits, soft drinks and beer are imported from different regions of Ukraine, and were not included in the study. In Table 3 we also included values of permissible levels (regulations of 1997) for Cs-137 and Sr-90 in food products included in the study [3].

Samples were collected and measured first on-site using LB200 gamma monitor (in 1992), and later in a laboratory. In 2001, on-site measurements were impossible due to low activities of samples. In 1992, milk samples were collected in two more villages of the same region.

Table 1. Soil contamination in and around Stepanivka.

Year	Cs-137		Sr-90	
	Number of samples	Activity (range), Bq/kg	Number of samples	Activity (range), Bq/kg
1992	10	530	3	34
2001	4	485 (250-825)	2	3.8 (2.0-5.5)

3. Results and discussion

Water. Two types of drinking water supply are used in the village: centralised supply from 120 m deep artesian well and private water wells 1 - 3 m deep. Some people use both pipeline water and wells. Water from artesian well was rather radioactive (total gamma-activity by LB200 monitor about 100 Bq/l - apparently radium, thorium and their daughter products - the region is known for its granite deposits). Average gamma activity of water in private wells (measured by LB200) was 59 Bq/l, ranging from 0 - 179 Bq/l. In this research, we had no opportunities for investigation of radioactivity of drinking water in details. In 1999, in the other study of villages in the same Polisse region and with similar level of radioactive contamination of soil (Cs-137 1.1 - 3.9 Ci/km²), Cs-137 activity of water in wells varied from 0.06 - 2.6 Bq/l [4]. According to this study, activity of water in 1992 was 9 times higher than in 1999.

Milk. Results of analyses of milk are presented in Table 2. Average contamination of milk with Cs-137 in 2001 was 9 times lower than in 1992. In our study, in 1992 average activity of five samples of hay was 500 Bq/kg (dry weight, measured by gamma-monitor LB200) and in 2001 activity of Cs-137 in two samples of hay were 1,125 and 711 Bq/kg. It is not possible to conclude what is the main source of radioactive contamination of milk - more detailed studies are needed.

Radioactive contamination of food samples is summarised in Table 3.

Meat, poultry, eggs and fish. Only several samples of meat, poultry, fish and eggs were available for measurements, because these food products are scarce and people plan their consumption (usually this is connected with seasonal or family celebrations, and even in these periods they are not in abundance).

Potato is very important as a food product and also as forage for pigs and chickens. All consumed potato is produced locally, and daily consumption for food is higher than the average for Ukraine (0.63 and 0.36 kg/day, respectively).

Mushrooms and berries. Fresh, canned, dried mushrooms (many different species) and berries (mainly blackberry *Vaccinium Myrtillus*) are very important food products in Stepanivka. Most people harvest them in forests and eat. People know that these products are radioactive, but they constitute very significant additives of protein (mushrooms), minerals and vitamins (berries) that are unavailable from other sources. When filling up interview sheets in 1992, we re-calculated fresh and canned berries into dry berries. In 2001, consumption of mushrooms and berries was apparently higher than in 1992, but we used the same figures for our calculations.

Calculation of intake of radionuclides. The results of calculation of intake of Cs-137 and Sr-90 from the main food items in the investigated area are presented in Table 3. The shares of Cs-137 intake from the main food products are plotted on two diagrams in Fig.1.

Table 2. Average activity of Cs-137 in milk samples, Bq/l; n - number of samples.

Village	1992				2001			
	Cs-137		Sr-90		Cs-137		Sr-90	
	n	Activity (range)	n	Activity	n	Activity (range)	n	Activity (range)
Stepanivka	51	228 (28-940)	6	0.34	10	25.5 (7.1-43.8)	4	1.00 (0.74-1.37)
Dibrova	14	71 (14-150)	-	-	-	-	-	-
Rudnia Radovelska	19	298 (45-720)	-	-	-	-	-	-

Table 3. Permissible levels of contamination (PL) and activity (Bq/l or Bq/kg) of water and food in Stepanivka, and average annual intake (Bq). Absent data are marked "na".

	Consumption (kg/pers/year)	Cs-137					Sr-90				
		PL (Bq/l, kg)	1992		2001		PL (Bq/l, kg)	1992		2001	
			Activity (Bq/l, kg)	Intake (Bq)	Activity (Bq/l, kg)	Intake (Bq)		Activity (Bq/l, kg)	Intake (Bq)	Activity (Bq/l, kg)	Intake (Bq)
Water	365	2	na		0.05	18	2	na		0.25	91
Milk	256	100	210	53,800	25.5	6,528	20	0.34	87	1.0	256
Meat, poultry	80	200	62	5,000	43.9	3,512	20	na		0.5	40
Fish	0.6	150	330	200	47	28	35	na		2.2	1.3
Eggs (pieces)	300	6	1.5	450	na		2	na		na	
Potato	230	60	12	2,800	14.9	3,427	20	na		0.5	115
Dry mushrooms	0.7	2,500	30,500	21,300	20,047	14,033	250	na		4.8	3.4
Dry berries	0.3	2,500	18,000	5,400	17,650	5,295	250	4.5	1.4	56.6	17
Total intake from local food				88,950		32,841*					523*

*Including water

**Annual intake of Cs137 with local food in 1992
(total 88 kBq)**

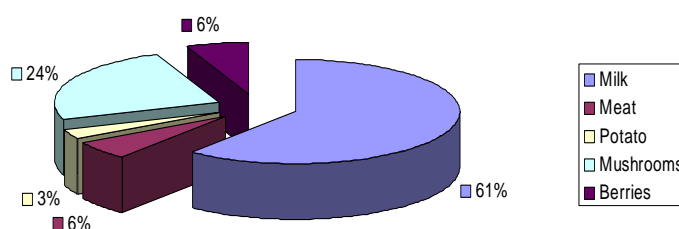

**Annual intake of Cs137 with local food in 2001
(total 33 kBq)**

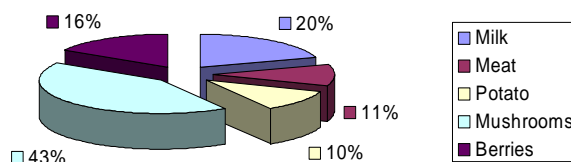

Fig.1. Intake of Cs-137 from main food sources.

Discussion

From the results of our study it is clear that average intake of Cs-137 in 2001 is almost three times lower than in 1992: 89 kBq and 33 kBq, respectively. In 1992, milk contamination accounted for 61 % of annual intake of Cs-137, and mushrooms and berries accounted for 30 % together. In 2001, the share of milk dropped to 20 % and the share of mushrooms and berries became 59 %. The content of Cs-137 in berries and mushrooms has been more or less stable in 1992-2001, as it was also shown in other studies (see, for example, [5] for the period 1991-1999).

Our results prove that Stepanivka is located in a rather "good" area, because in many other villages (even to the west of Stepanivka) radioactive contamination of milk remains significantly higher. In 1998, out of 34,233 samples of private sector milk in Ukraine, contamination of 19.7 % of them with Cs-137 was higher than permissible level 100 Bq/l [6].

It is also clear that contamination of food with Sr-90 increased significantly: almost three times for milk and 12 times for dry berries. There exist numerous investigations which show that the migration of Sr-90 in plants increases with time due to chemical transformations of deposited fuel particles. (See, for example, a paper by Yu.O.Ivanov with quite comprehensive bibliography [7]).

In 1992, we used (to make a rough estimate) the results presented by Smoliar [2] that an intake of each kBq/year of Cs-137 results in an annual dose of 0.011 mSv/year. In this case the average dose in Stepanivka (from locally produced food) was 1.2 mSv/year in 1992. This dose was lower than 1992 permissible level of 5 mSv/year.

Later, several regulations on calculation of internal doses from food and other sources were published by international organizations and in Ukraine [see, for example, 8]. But, if we use the same assumption by Smoliar for Cs-137 intake results of 2001, then the annual dose from local food would be 0.37 mSv/year,

which is lower than the permissible radiation dose for population - 1 mSv/year, stipulated by National Radiation Protection Norms. Of course, this calculation does not account for doses from incorporated strontium and alpha-emitters, as well as for inhalation and external irradiation doses. As it is shown in [3], for people living in similar environment, internal irradiation from food contamination by Chernobyl radionuclides comprises only about 40 % of the total internal dose, while 60 % of internal dose is formed by natural radionuclides such as Rn and Tn and their daughter products (results of the 1996-1997 studies; the paper provides a breakdown of the total intake of Cs-137 and Sr-90 from various food products).

It should be noted, however, that we did not investigate patterns of individual intake of radionuclides, which vary very significantly even for people living in the same village.

Acknowledgements

The paper was discussed and recommended for publishing at the Laboratory of Radiation Hygiene of the Institute of Hygiene and Medical Ecology of the Academy of Medical Science of Ukraine.

The author expresses his gratitude to Prof. Edmund Lengfelder from Munich University who organized donation of equipment to Ukrainian Ecological Association "Green World" in 1990, Dr. Lyudmila Nagovitsyna from Ukrainian Scientific Hygien Center, and Imanaka Tetsuji from Kyoto Research Reactor Institute for the support of the second stage of the study.

The author also thanks the people of Stepanivka village and Luginy district, first of all Mykola Kaminsky, the Head of the village Council and Yuri Grinevytch, teacher, and Volodymyr Prekrasny and Volodymyr Ovdienko who participated in field expeditions and measurements.

References

1. Mikhailov A.V., Los I.P., Bogdanov G.O. Results of assessment of partial input of some food products in internal doses... In: Nauka. Chernobyl-97 (*Science. Chernobyl-97*). Proceedings of the Conference 11-12 February 1997. Kiev, 1998. p.128.
2. Smoliar V.I. Ioniziruyushaya radiatsia i pitanie (*Ionizing Radiation and Nutrition*). Kiev, 1992. 173 p. (in Russian).
3. State of Environment in Ukraine. National Report. - Ministry for Environmental Protection and Nuclear Safety of Ukraine. Kyiv, 1999. p.33.
4. Bobyliova O.O. et al. Hygienic Assessment of Living Conditions of People... - In: Chernobyl. Exclusion Zone. - National Academy of Science of Ukraine. Kyiv, 2001. pp.268-277 (in Ukrainian).
5. Orlov O.O. et al. Patterns of accumulation of Cs137 by mushrooms and berries... - In: Hygiene of Settlements, Issue 36, Part 1, Ministry of Health of Ukraine, Kyiv, 2000. pp. 431-445.
6. V.I.Tsypryan, A.A.Myshkovska. Control of content of main dose-forming radionuclides... in Ukraine. In.: Higiena Naselennyh Mest (*Hygiene of populated localities*). Vol.36, Part 1. Kiev, 2000. - p.42.
7. Yu.O.Ivanov. Dynamics of Redistribution of Radionuclides in Soils and Plants. - In: Chernobyl. Exclusion Zone. - National Academy of Science of Ukraine. Kyiv, 2001. pp.47-76 (in Ukrainian).
8. International Basic Safety Standards for Protection against Ionizing Radiation... Safety Series 115-I. Vienna, 1994. - 387 p.

Content of Radionuclides of Chernobyl Origin in Food Products for the Belarusian Population

Vladimir P. MATSKO and Tetsuji IMANAKA*

*Institute of Radiobiology, Academy Sciences of Belarus
Kuprevich str. 2, 220141 Minsk, Belarus: irb@radbio.bas-net.by*

**Research Reactor Institute, Kyoto University
Kumatori-cho, Osaka, 590-0494 Japan: imanaka@rri.kyoto-u.ac.jp*

Abstract

Recent data on radionuclide contents of Chernobyl origin in food products and drinking water for the Belarusian population are reviewed. Strontium-90 and Cesium-137 are main radionuclides contributing to internal irradiation to the population. Contamination levels in food products from the social sector of agriculture (collective farms, agricultural co-operatives) are found to be generally below the current legal admissible level of RAL-99 that are defined to make internal dose of the population less than 1 mSv/yr. On the other hand, exceedings of RAL-99 are often found in food products from the private sector, especially in settlements of Gomel region where the contamination is the most serious in Belarus. Special attention should be paid to the non-farm products in the contaminated areas: mushrooms, berries, fish and meat of wild animals. For example, about 37,000 Bq/kg of ^{137}Cs in fresh mushroom was registered in a settlement of Gomel region, which corresponds to 100 times of RAL-99 values. Concerning drinking water, the situation is quite good and no exceedings have been registered for the last 10 years.

Introduction

The Chernobyl APS accident led to heavy socio-economic consequences and worsening of the environment in a large number of territories in Republic of Belarus as a result of their pollution with radioactive components including ^{90}Sr and ^{137}Cs . Presently, these two radionuclides are the principal dose-forming factors of radiation on man and the most typical radioactive contaminants of food products. As the majority of radioactive substances enter into human organisms together with food, there is a permanent necessity to develop the measures on radiation protection of population from incorporated radioisotopes ^{90}Sr and ^{137}Cs .

In order to decrease radionuclide incorporation with food, legal measures are taken in Belarus by setting admissible levels for ^{90}Sr and radiocesiums (^{137}Cs and ^{134}Cs) in food products. Current regulation of radionuclide contents in food products is carried out in correspondence with Republican Admissible Levels (RAL) adopted in 1999 (Table 1). The RAL values are defined so that annual internal dose of the population does not exceed the dose limit of 1 mSv/yr as far as the structure of their food consumption is typical in Belarus. Within the structure of food consumption by the Belarusian population, the share of potato, milk and bread constitutes more than 50%. This allows to consider them as the group of principal products.

In this paper the recent situation of radionuclide contents in food products in Belarus is overviewed.

Food products from the social sector

The majority of food products in Belarus are produced by the social sector of agriculture (collective farms, agricultural co-operatives).

^{90}Sr in principal products:

Strontium-90 activity in milk, potato, rye bread and wheat bread from the social sector in Brest, Minsk,

Table 1. Admissible levels of radionuclide content in food products and drinking water of Belarus population (RAL-99).

Product	RAL-99	
	Cesium radionuclides, Bq/kg, Bq/l	Strontium-90 Bq/kg, Bq/l
Drinking water	10	0.37
Milk and dairy products	100	3.7
Meat and meat products		
- beef, mutton products	500	-
- pork, poultry products	180	-
Potato	80	3.7
Root crops	80	-
Bread, bakery products	40	3.7
Flour, groats, sugar	60	-
Vegetable and animal fats, margarine	40	-
Vegetables	100	-
Fruits and berries	70	-
Canned vegetables, fruits and berries	74	-
Forest berries	185	-
Fresh mushrooms	370	-
Dried mushrooms	2,500	-
All species of children food ready for consumption	37	1.85
Other food products	370	-

-, RAL is not defined.

Vitebsk, Grodno and Mogilev regions registered in 2000 is shown in Table 2 [1]. The ^{90}Sr activity in milk, potato, rye and wheat bread generally does not exceed 0.25, 0.33, 0.34 and 0.33 Bq/kg, respectively.

In Gomel region where the radionuclide contamination is the most serious, some higher levels of ^{90}Sr – as compared with the mentioned – in rye and wheat bread and milk were registered (Table 3). Their averages in Gomel region were 0.89, 1.05 and 0.54 Bq/kg, respectively, and higher than on the whole in the country. The observed difference in ^{90}Sr pollution of the mentioned products in compared regions is a result of radioactive pollution of Gomel region which is higher than that of other Belarus areas.

Among the examined food products from Gomel region, the highest level of ^{90}Sr (not higher, however, than the admissible level) in rye bread was registered from Vetka, and the highest in wheat bread and milk were from Mozyr (Table 3). The content of ^{90}Sr and ^{137}Cs in home-made cottage cheese constituted, respectively, 1.12 and 16.7 Bq/kg (Tables 3, 4). Such level of radioactive pollution of cottage cheese also does not exceed the admissible level even for children food (the requirements concerning the children food are the toughest).

According to the data by [2], in 2000 the mean level in Belarus of ^{90}Sr content in milk of dairy plants and children milk kitchens constituted 0.2 Bq/l.

The data of other authors [3, 4] testify that the levels of ^{90}Sr content in the principal food products from the mostly polluted areas of Gomel region are considerably higher than adduced in [1]. In 1999, the Sanitary-Epidemiological Service of Gomel region examined 448 samples of milk, dairy products, bread and bakery products, and in 2000 - 365 samples. There were found no cases of exceeding RAL-99 (3.7 Bq/l, kg). Nevertheless, it is necessary to note that the boundary levels of ^{90}Sr content were registered in samples, being close to the limit of 3.7 Bq/l:

- in 1999, milk – 3.52 Bq/l (Zhlobin cheese dairy plant),
- dairy products – 3.44 Bq/l (Kalinkovichi dairy plant),
- rye bread – 3.12 Bq/kg (Bragin bread factory);
- in 2000, dairy products – 3.29 Bq/l (Rogachev dairy plant),
- rye bread – 3.00 Bq/kg (Korma bread factory),
- wheat bread – 3.0 Bq/kg (Narovlya bread factory).

Table 2. Levels of ^{90}Sr activity in food products from the social sector in Mogilev, Vitebsk, Brest, Minsk and Grodno regions.

Food product	Settlement	Region	Level of ^{90}Sr activity, Bq/kg
Milk	Bobrujsk	Mogilev	<0.15
	Mogilev	Mogilev	0.19±0.01
	Lepel	Vitebsk	<0.15
	Brest	Brest	<0.15
	B. Maleshevo	Brest	0.25±0.02
	Volozhin	Minsk	<0.15
	Vilejka	Minsk	<0.15
	Zhdanovichi	Minsk	<0.15
	Grodno	Grodno	<0.15
	Volkovysk	Grodno	<0.15
Potato	Bobrujsk	Mogilev	<0.15
	Slavgorod	Mogilev	0.21±0.01
	Polotsk	Vitebsk	0.33±0.03
	Novopolotsk	Vitebsk	0.33±0.04
	Logojsk	Minsk	0.26±0.03
	Volkovysk	Grodno	0.18±0.02
Rye bread	Bobrujsk	Mogilev	0.34±0.02
	Mogilev	Mogilev	<0.15
	Bykhov	Mogilev	0.18±0.02
	Novopolotsk	Vitebsk	<0.15
	Brest	Brest	0.27±0.02
	Baranovichi	Brest	<0.15
	Vilejka	Minsk	0.23±0.02
Wheat bread	Bobrujsk	Mogilev	<0.15
	Mogilev	Mogilev	<0.15
	Slavgorod	Mogilev	0.33±0.03
	Novopolotsk	Vitebsk	0.33±0.03

Table 3. The density of radioactive pollution of territory in places of sampling and the levels of ^{90}Sr activity in food products from the social sector in Gomel region.

Density of pollution with ^{90}Sr , Ci/km ²	Food product	Level of ^{90}Sr activity, Bq/kg
Svetlogorsk		
<1	Milk	0.28±0.02
<1	Wheat bread	0.70±0.04
<1	Rye bread	0.96±0.04
Gomel		
<1	Milk	0.59±0.05
<1	Wheat bread	0.50±0.04
<1	Rye bread	0.20±0.01
Mozyr		
<1	Milk	0.76±0.04
<1	Wheat bread	1.96±0.16
<1	Rye bread	0.90±0.06
<1	Cottage cheese*	1.12±0.11
Vetka		
1-2	Rye bread	1.49±0.13
In the region on the average	Milk	0.54
	Wheat bread	1.05
	Rye bread	0.89

*; Cottage cheese is not from the social sector.

Table 4. Density of radioactive pollution of territory and levels of ^{137}Cs activity in dairy products from the social sector in Gomel region.

Settlement	Density of pollution of territory with ^{137}Cs , Ci/km ²	Food product	Specific ^{137}Cs activity, Bq/kg
Svetlogorsk	<1	Milk	<3.75
Gomel	1-5	Milk	16.0±3.4
		Sour cream	13.3±2.8
Mozyr	1-5	Milk	17.0±3.5
		Cottage cheese	16.7±3.6

^{137}Cs in principal products:

The levels of ^{137}Cs activity in milk, bread and potato from the social sector of Brest, Grodno, Vitebsk, Minsk and Mogilev regions were considerably lower than the existing normative values and in the majority of cases they did not depend on the place of sampling. The results of Gomel region became exception, where the correlation was found between the level of ^{137}Cs activity in milk of local production and the density of radiocontamination of territory (Table 4). Whereas, the ^{137}Cs levels in milk and other food products from social sector in Gomel region were considerably lower than the values of admissible levels.

The Sanitary-Epidemiological Service of Gomel region examines annually potato from economies situated within the zones of radioactive pollution. In 1999–2000, exceedings of RAL-99 were found in 2 economies of Bragin district. That potato was not consumed as food product. In 2000-2001, there were no exceedings of RAL-99 found in other foods produced in the social sector, such as meat products, fish, vegetables, berries, fruits, eggs, children food [5].

On the whole, the agricultural protective measures in the social sector allowed to observe the normative values of ^{137}Cs content in milk which were valid in that period: up to 370 Bq/l in 1987, up to 185 Bq/l in 1990, up to 111 Bq/l in 1992, up to 100 Bq/l in 1999. Nearly 99% of milk samples from the social sector had specific activity of ^{137}Cs less than 20 Bq/l, whereas the normative value of RAL-99 is 100 Bq/l. However, in 1999 there were registered 1,962 tons of milk with ^{137}Cs content over 100 Bq/l. That milk was processed in dairy plants for butter.

Food products from the private sector

^{137}Cs in milk and potato:

Much more anxiety is caused by the quality of food produced in the private sector of agriculture. This may be explained by the limited possibilities in taking full-value protective measures. According to the data of Sanitary-Epidemiological Service, there were registered multiple cases of producing milk with high ^{137}Cs content in the private economies (Table 5).

While in the social sector the milk with exceeding radionuclide contents may be used as raw material for re-processing, in the private economies it is mainly used for personal consumption, being thus dangerous for the health of man, especially for children.

Table 5. Number of settlements in each region of Belarus where exceedings of RAL-96, RAL-99 were registered for ^{137}Cs content in milk from the private sector.

Region	Over 111 Bq/l (RAL-96)		Over 100 Bq/l (RAL-99)	
	1997	1998	1999	2000
Brest	97	90	73	54
Gomel	380	351	143	225
Grodno	7	2	4	4
Minsk	7	7	3	1
Mogilev	89	66	56	43
Belarus	580	516	379	327

The ^{137}Cs content in randomly selected milk samples reached the following values [6];

in Gomel region: Lelchitsy district – 979 Bq/l,

Bragin district – 637 Bq/l,

Korma district – 394 Bq/l,

in Mogilev region: Chausy district – 851 Bq/l,

Slavgorod district – 776 Bq/l,

Krasnopol'e district – 913 Bq/l,

Bykhov district – 625 Bq/l.

In 2000, the organs of state sanitary control of Gomel region examined 39,261 milk samples from the personal subsidiary economies (PSE). Exceedings were found in 4.8% of samples (1,873 samples). The maximum share of milk with RAL exceedings was registered in Lelchitsy (19.6%), Narovlya (14.9%), Vetka (13.1%), El'sk (9.0%) and Chechersk (8.3%) districts.

The maximum specific activity of radiocesium in milk samples was registered as follows:

- Khojniki district - 894 Bq/l,
- El'sk district - 889 Bq/l,
- Narovlya district - 872 Bq/l,
- Lelchitsy district - 803 Bq/l.

In 2000, in 326 settlements of Gomel region were registered cases of exceeding RAL-99 of radiocesium contents in single samples of meat, meat products, potato, beet. In 1999, the RAL exceedings were found in 259 settlements. The number of settlements with RAL exceedings was registered as follows: in Bragin (in 2000 – 30 settlements, in 1999 – 11), Vetka (26 and 30, respectively), El'sk (25 and 21), Lelchitsy (41 and 36), Narovlya (23 and 22), Chechersk (40 and 33) and Khojniki (19 and 17) districts.

In 2000, the RAL exceeding in potato was registered only in one sample from v. Dzerzhinsk of Narovlya district of Gomel region [3].

In Minsk region which was polluted much less than Gomel region, there were almost no cases of exceeding the RAL of ^{137}Cs in principal food products from the private sector (Table 5). However, the radioactive pollution of agricultural products in relatively “clean” Minsk region is tens of times as high as the pre-accidental levels [7].

^{90}Sr in milk, potato and vegetables:

The precipitations of ^{90}Sr of Chernobyl origin are registered mainly in Gomel region. In 2000, the Sanitary-Epidemiological Service of Gomel region examined the products of PSE in 282 settlements: milk was examined in 264 settlements. On the whole in 2000, 1,613 samples of food products from PSE were examined. Out of 605 milk samples examined, exceedings of strontium were found in 45 samples (7.4%), and out of 331 potato samples the exceedings were found in 5 (1.5%).

In 2000, the RAL exceedings of ^{90}Sr in milk were registered in 35 settlements, in potato – in 3 settlements. The maximum levels of ^{90}Sr content in milk were registered as follows:

- Bragin district - 13.6 Bq/l,
- Khojniki district - 8.4 Bq/l,
- Narovlya district - 7.89 Bq/l,
- Dobrush district - 4.8 Bq/l.

Taking into consideration the results of observations for 4 years (1997-2000), the RAL exceedings of ^{90}Sr in milk and potato from PSE were registered in 93 settlements of Gomel region. Constant RAL exceedings of ^{90}Sr during four and more years of observation were registered in the samples of PSE products in 14 settlements of Gomel region, including 9 settlements in Bragin, 4 in Khojniki and 1 in Narovlya districts.

The Sanitary-Epidemiological Service of Gomel region carries out the monitoring of widely consumed

Table 6. The share (%) of samples of food products from the personal subsidiary economies which do not meet the requirements of RAL-99.

Food product	2000		2001	
	Cesium-137	Strontium-90	Cesium-137	Strontium-90
Milk	5.0	5.3	4.2	8.5
Dairy products	3.0	-	2.0	-
Meat and meat products	1.2	-	0.4	-
Potato	0.03	0.7	-	-
Vegetables	0.02	-	0.02	-

PSE products for which ^{90}Sr limitations are not defined in RAL-99: root crops and vegetables. Attracts attention the fact that quite high ^{90}Sr contents are registered in the samples of beet, carrot, cabbage in the region. In 2000, the maximum levels of ^{90}Sr content in these products were as follows:

- Beet in Bragin district - 18.6-34.3 Bq/kg,
- Carrot in Khojniki district – 43.3 Bq/kg,
- Cabbage in Khojniki district – 35.8 Bq/kg, in Narovlya district – 29.3 Bq/kg.

Quite high levels of ^{90}Sr content are also registered in samples from PSE of more “well-being” districts of region [3, 4]:

- Cabbage – 11.4 Bq/kg (El'sk district),
- Carrot – 7.9 Bq/kg (Kalinkovichi district), 12.7 Bq/kg (Vetka district), 15.6 Bq/kg (Dobrush district),
- Beet – 12.7 Bq/kg (Kalinkovichi district).

In Belarus as a whole, the RAL-99 exceedings of ^{137}Cs were registered in milk and dairy produce as well as in single samples of meat and vegetables from PSE. About ^{90}Sr contents, the RAL-99 exceedings were registered only in milk from settlements of Gomel region (Table 6) [5].

Forest products

Belarus population consume also non-farm products that are not principal but – being more polluted – make sometimes very significant contribution into the dose commitments. During a number of years, in Mogilev region and especially in Gomel region the RAL exceedings are registered in 30-40 % of samples of wild berries and mushrooms (fresh and processed), and more than in 50 % of dried mushrooms prepared for personal consumption. The RAL exceedings in these foods are registered in all districts of Gomel region. In separate districts the exceedings are 70 % or more (Vetka, El'sk, Bragin, Narovlya, Korma and other districts).

Table 7 shows the ^{137}Cs contents of forest products that were randomly selected in 1994-1995 in Mogilev and Gomel regions and measured by sanitary-epidemiological services of Mogilev and Gomel regions [6]. The data in Table 7 considerably exceed the existing norms.

The maximum levels of radiocesium content in mushrooms exceed RAL up to 100 times. For example, in 1999, in a sample of fresh mushroom from El'sk district the specific activity of radiocesium constituted 36,896.5 Bq/kg, while the RAL value is 370 Bq/kg [2, 3, 8].

In 2000, the following maximum levels of ^{137}Cs content were registered in Gomel region:

- Fresh mushroom from Korma district – 25,470 Bq/kg (75 times as high as RAL of 370 Bq/g),
- Wild berries from Narovlya district – 4,742 Bq/kg (26 times as high as RAL of 185 Bq/kg),
- Dried mushrooms from Rogachev district – 99,910 Bq/kg (40 times as high as RAL of 2,500 Bq/kg),
- Dried mushrooms from Khojniki district – 90,950 Bq/kg (36 times as high as the norm).

The consumption of wild berries and mushrooms with exceedings of RAL leads to high doses of

Table 7. ^{137}Cs contents in separate samples of meat of wild animals, mushrooms and forest berries from Mogilev and Gomel regions.

Region	District	^{137}Cs content in “dirty” food products, Bq/kg (random sampling)
Meat of wild animals (boars, elks, hares and others)		
Mogilev region:	Slavgorod district	1,974
	Cherikov d.	9,620
	Bykhov d.	15,910
	Klichev d.	7,445
Gomel region:	Korma d.	18,000
	Lelchitsy d.	17,659
	Vetka d.	9,768
	Bragin d.	11,407
Mushrooms (fresh)		
Mogilev region:	Krasnopol’e d.	875
	Cherikov d.	1,079
	Bykhov d.	2,512
	Slavgorod d.	966
Gomel region:	Korma d.	793
	Lelchitsy d.	1,984
	Bragin d.	915
	Bykhov d.	769
Wild berries		
Mogilev region:	Slavgorod d.	758
	Cherikov d.	993
	Bykhov d.	1,134
Gomel region:	Korma d.	1,754
	Lelchitsy d.	1,017
	Bragin d.	795

Table 8. Share (%) of samples not meeting the requirements of RAL-99 for ^{137}Cs in 2000 and in 2001.

Region	Mushrooms		Forest berries		Meat of wild animals	
	2000	2001	2000	2001	2000	2001
Brest	15.6	25.3	40.2	23.6	-	-
Vitebsk	4	11.5	6.7	2.3	-	-
Gomel	46.9	47.8	36	32.7	54.8	66.2
Grodno	25	28.5	7.7	1.25	-	-
Minsk	19.1	19.2	9.04	4.8	1/1*	-
Mogilev	32.4	33.3	26.2	31.2	68.7	64.7
Minsk city	16.3	21.1	6.9	6.4	2/2*	-

*; (Number of dirty samples)/(Number of measured samples).

internal irradiation. In case of non-observation of existing limitations of consumption for mushrooms and wild berries, the contribution of forest products into the formation of internal irradiation dose reaches 70% in a number of settlements of the region (by the data of Gomel branch of Research Institute of Radiation Medicine and Endocrinology).

In Table 8 is adduced the share of samples of mushrooms, forest berries and meat of wild animals, which do not meet the requirements of RAL-99 in all regions of Belarus [5].

Fish

The fish of local catch makes its own contribution into the formation of internal irradiation dose of population of region. In 1999, the RAL-99 exceedings of ^{137}Cs in fish of local catch were registered in 9.7%

Table 9. Causes of exceedings of internal irradiation dose of population of Gomel region in 1998-2000.

Cause of exceeding the dose	Years					
	1998		1999		2000	
	number of cases		number of cases		number of cases	
	Total	Share (%)	Total	Share (%)	Total	Share (%)
Wild berries and mushrooms	732	57.6	308	30.4	458	53.4
Milk from PSE	232	18.3	140	13.4	72	8.4
Fish from rivers	47	3.7	303	28.8	-	-
Meat of wild animals	99	7.8	56	5.4	141	16.4
Unknown	160	12.6	240	22.0	187	21.8

(13 samples out of 134), in 2000 – in 17.4% (21 samples out of 121). The samples of fish with RAL-99 exceedings were registered in the private sector of eight districts of Gomel region: Vetka, Dobrush, Kalinkovichi, Petrikov, Narovlya, Rechitsa, Khojniki and Mozyr town. They reached 36% (Narovlya district), 50% (Rechitsa district) and 82% (Khojniki district). The maximum levels of radiocesium content in fish from reservoirs and rivers of the region were 11 times as high as RAL-99 in 1999 and 25 times – in 2000 (Vetka district, maximum level – 9,310 Bq/kg).

Drinking water

When we speak about the radiation state of food products of Belarus population, we must mention drinking water. In 2000, there were more than 3,000 samples of water from water pipes, wells, artesian wells and open reservoirs in which ^{137}Cs was measured, and near 100 samples in which ^{90}Sr was measured. There were found no water samples with exceedings of RAL-99. The samples of drinking water with exceedings of norms were not registered in Belarus during the last ten years, testifying thus to quite good situation [2].

Formation of radiation dose

Internal dose:

In case of observing RAL-99 of radionuclide contents in food products, dose values of internal irradiation are not higher than 1 mSv/year [9]. In the real situation, however, there are being registered many people whose internal dose exceeds the normative value due to the radionuclide intake through food products.

Taking into account the results of laboratory studies of food products, the contribution of various foods to the exceedings of annual internal dose limit was analyzed [3]. As seen in Table 9, the consumption of wild berries and mushrooms by population comes to the first place. In Gomel region, the exceeding of internal dose in 1498 persons (47.2% of registered number of persons) is connected with that cause. The second component of exceeding the irradiation norm is the consumption of milk from the private subsidiary economies: 444 persons (14%). 296 cases (9.3%) are connected with consumption of meat of wild animals, 350 cases (11%) – with consumption of fish from local reservoirs, in 587 persons (18.5%) the cause was not revealed.

Table 10. Annual external dose registered among the critical groups working on polluted territories in Gomel region.

Group	Annual external dose (mSv/yr)		
	1998	1999	2000
Agricultural mechanics	1.5 – 1.9	1.5 – 1.8	1.6 – 2.0
Animal breeders	1.6 – 2.9	1.5 – 1.9	1.8 – 2.2
Field workers	1.5 – 1.9	1.5 – 1.7	1.9 – 2.0
Foresters	2.0 – 2.5	2.0 – 2.4	1.8

External dose:

In the last three years, a tendency of decrease is observed in the average annual doses of external irradiation of the population living on polluted territories. Whereas, during a number of years, the cases of high indices of dosimeters have been registered in separate critical groups (field workers, animal breeders, foresters). Annual external dose of these groups is summarized in Table 10, which testifies to the exceedings of dose limit of 1 mSv/year. The analysis of seasonal trend of external dose shows that maximum values of irradiation (2 times and higher) as compared with the average annual indices in critical groups are registered in period of spring-autumn, when field works are carried out and the population is picking mushrooms and forest berries [3].

Conclusion

The content of radionuclides in food products of population of the Republic of Belarus, which have been produced in social sector of agriculture, as a rule, does not exceed the norms of Republican Admissible Levels of 1999. The products from personal economies are of worse quality, from the point of view of radiation hygiene. Considerable contribution into the dose of internal irradiation can be made by so-called “non-traditional” food products: meat of wild animals, fish from open reservoirs, wild berries and mushrooms.

Literature

1. Murokh V.I., Rogovaya E.G., Shakun M.L., Zajtsev V.A. **Study of levels of Strontium-90, Cesium-137 activity and calcium content in food products in the connection with development of issues of radiation protection of population of the Republic of Belarus**//“National Policy of Sound Alimentation in the Republic of Belarus”, Proceedings of International Conference, 26-27 Apr. 2001, Minsk. (In Russian)
2. Gaevskij I.V., Lipnitskij L.V., Sharamkov V.A. et al. **Assessment of radiation-hygienic situation**//“75 Years of Sanitary-Epidemiological Service of the Republic of Belarus”. Proceedings of Science-Practical Conference, 22-23 Nov. 2001, Minsk (In Russian)
3. Medico-Ecological Bulletin. Issue 6. 2001, Gomel. (In Russian)
4. Zinovich V.N., Klyuchenovich V.I., Sergeenko E.V., Vlasova I.K. **On the results and problems of Strontium-90 control in food products**//“Belarus and Chernobyl. 15 Difficult Years”, Proceedings of International Science-Practical Conference, v. 1, 4-6 Apr. 2001, Gomel. (In Russian)
5. Radiation Control Of Food Products. Information Bulletin. no. 12. 2001, Minsk (In Russian)
6. Instruction for Population Living on Territory Polluted with Radioactive Substances. Issue 2. 1997, Minsk (In Russian)
7. Kolosovskij B.S., Valetko I.I., Alekhnovich M.V. **Comparative hygienic assessment of Cesium-137 intake by the organism of people living in Minsk region in 1985 and 1995**//“National Policy of Sound Alimentation in the Republic of Belarus”, Proceedings of International Conference, 20-21 Nov. 1997, Minsk. (In Russian)
8. Perevolotskij A.N., Bulavik I.M., Potylkin N.A. **Dynamics of Cs-137 and Sr-90 accumulation in forest food products**//“Biochemical Technologies And Ecological Safety”. Proceedings of International Science-Practical Conference. 15-17 May 2001, Minsk (In Russian)
9. Kenigsberg Ya.Eh., Buglova E.E. **Limitation of dose of internal irradiation of Belarus population by the way of setting hygienic norms of radionuclide contents in food products**//“Belarus and Chernobyl. 15 Difficult Years”, Proceedings of International Science-Practical Conference, v. 1, 4-6 Apr. 2001, Gomel. (In Russian)

Long-Term Observation of Radioactivity Contamination in Fish around Chernobyl

Igor N. RYABOV

*A.N.Severtsov Institute of Ecology and Evolution, Russian Academy of Sciences
Leninski pr. 33, Moscow, 117071, Russia: platon@genome.eimb.relarn.ru*

Abstract

Dynamics of ^{137}Cs accumulation by marketable fishes in different kinds of water bodies (cooling pond, water reservoir, lake) polluted by radionuclides after the Chernobyl accident has been studied. The highest concentration of ^{137}Cs , reaching 500 kBq/kg w.w. (wet weight) was registered in fish inhabiting the cooling pond of ChNPP in 1986. During the last 15 years the level of radionuclides in fishes of all water bodies came down, but rates of lowering are different. Peculiarities of ^{137}Cs accumulation by fishes depending on the trophic level have been revealed. During the first months after the Chernobyl accident the concentration of ^{137}Cs in peaceable species of fishes in Kiev Reservoir was by 10 times higher than in pike. After 1987 predatory fishes have the concentration of ^{137}Cs by 2-3 times higher than peaceable fishes. Higher indices have been marked in pike and large perches. By 2001 the content of ^{137}Cs in fishes in the cooling pond did not exceed 5 kBq/kg w.w., in River Teterev – 0.09 kBq/kg w.w., in Kiev Reservoir – 0.5 kBq/kg w.w. High content of ^{137}Cs remained in the lakes of Bryansk region of Russia and in Mogilev region of Belorussia, which have low content of +K in water and stagnant water, although these lakes are situated 100 - 200 km from the place of the accident. Biological effects of fishes in morphology of body and reproductive system have been marked in all studied water bodies. The largest quantity of abnormalities in the reproductive system has been marked in predatory fishes.

Introduction

The Chernobyl accident of 1986 resulted in contamination of many bodies of water around Europe. Three branches of radioactive plume dispersed radionuclides over northern, southern and western Europe. Radioactivity from man-made nuclides increased considerably in freshwater bodies of Scandinavian countries, England and in mountain lakes in Germany [1]. Forests and water bodies, located in close proximity of Chernobyl NPP (*i.e.* within 30-km zone) appeared to be the most heavily contaminated along with Gomel' and Mogilev region of Belarus, and Bryansk region in Russia [2,3].

A Combined Radioecological Expedition of USSR Academy of Sciences attached to the A.N.Severtsov Institute of Evolutionary Animal Morphology and Ecology (now A.N.Severtsov Institute of Ecology and Evolution, Russian Academy of Sciences) started its activity in the field of radioecology of fish directly at the cooling pond of Chernobyl NPP in June, 1986. Later on, some other heavily contaminated bodies of water, such as Kiev Reservoir, River Teterev, Lake Kozhanovskoe (Russia) and Lake Svyatoo (Belarus) have been studied (Fig. 1).

The main objectives of our activity were:

- (a) To study the dynamics of radionuclide accumulation in fish after the Chernobyl accident in different ecosystems such as cooling pond, river, lake, and reservoir;
- (b) To reveal peculiar features of ^{137}Cs and ^{90}Sr accumulation in fish of different trophic level;
- (c) To evaluate doses of radiation and to find out their biological effects in fish living under the influence of chronic irradiation.

Studied bodies of water differ by their hydrology, hydrochemistry and by the distance from the site of

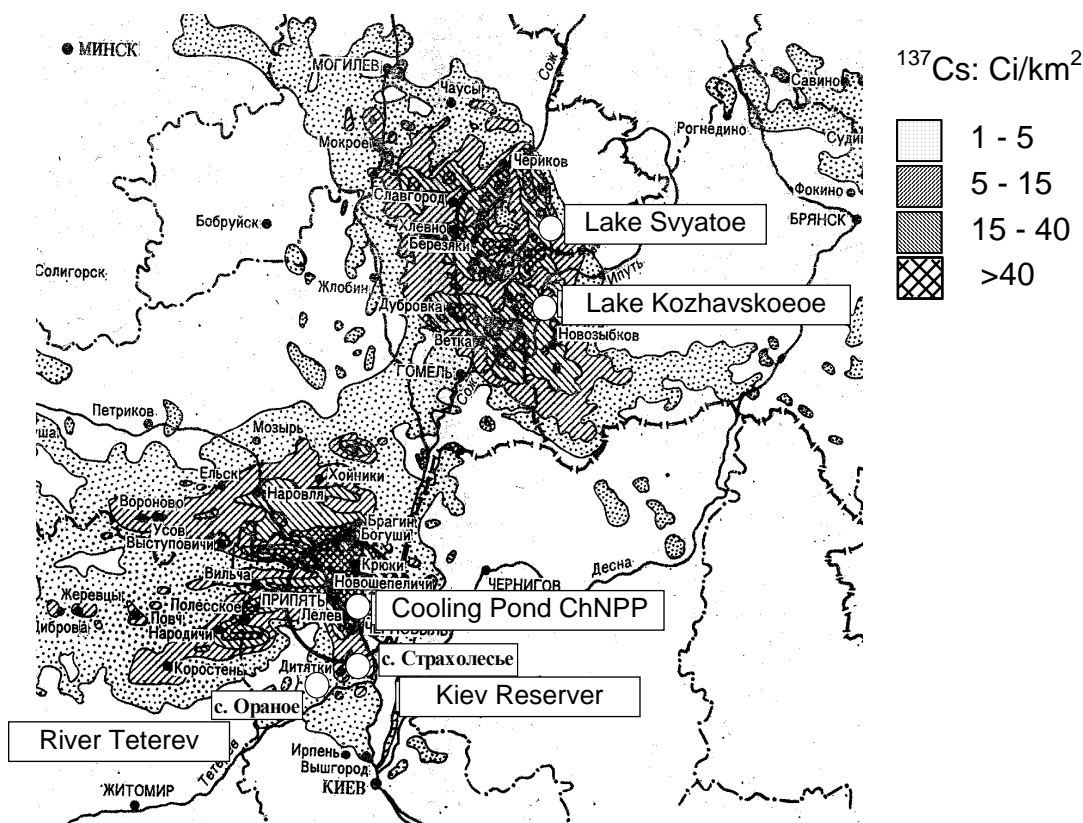

Fig.1. Regions of expedition activity at water bodies contaminated by radionuclides after the Chernobyl accident.

release (Table 1).

In all, 45 species of fish from 12 families and one species of Cyclostomata have been registered during multiple fish surveys (Table 2). The highest number of fish species was registered in River Teterev. Natural water bodies are populated by a set of species, typical of this part of Europe. Different from the natural bodies of water, the cooling pond of Chernobyl NPP was used before the accident as a raising pond for a fish farm and contained several introduced species. These were grass carp, silver carp and spotted silver carp of Chinese origin as well as North American bigmouth buffalo and bullhead. The isolated individuals of grass carp and silver carp may be found in Kiev Reservoir.

Altogether, more than six thousand individuals belonging to 46 species have been studied morphologically. More than four thousand samples have been analyzed in a laboratory of radiation spectrometry. Scintillometer RTF 20026 (made in Germany) has been used to evaluate the concentration of ^{137}Cs in different samples. Dose assessment has been done using the data on radionuclide concentration in muscles and the gut content of fish according to the method suggested by S.V.Kazakov [4], taking into account the main biological parameters, such as size and weight, of every studied individual.

Table 1. Hydrological and hydrochemical characteristics of studied bodies of water.

Water body	Area, km ²	Max. depth, m	Volume, m ³	Distance from ChNPP, km	K ⁺ , mg/l	Ca ⁺⁺ , mg/l
Cooling pond of ChNPP	22	18	150×10 ⁶	1.5	3.4-4.0	37.0-64.0
Kiev Reservoir	922	14.5	3.7×10 ⁹	60	2.9-3.4	32.4-60.0
River Teterev	-	20	-	80	3.1-3.4	35.5-40.5
Lake Kozhanovskoe	6	2.5	9×10 ⁶	210	2.6-2.7	24.6-44.3
Lake Svyatoye	0.25	5.1	7×10 ⁴	225	0.9-1.0	17.4-19.8

Table 2. List of species Cyclostomata and fishes registered during work of the Complex Radioecological expedition of A.N. Severtsov Institute of Ecology and Evolution RAS.

	Species	Cooling pond	Kiev Reservoir	River Teterev	Lake Kozharnovskoe	Lake Svyatoye	
I. Petromyzontidae	1. Ukrainian lamprey - <i>Eudontomyzon mariae</i> (Berg) x	+		+			
II. Clupeidae	2. Common kilka – <i>Clupeonella cultriventris cultriventris</i> (Nord.)	+	++				
III. Esocidae	3. Pike – <i>Esox lucius</i> L.	+	+++	+++	+++	++	
IV. Cyprinidae	4. Roach – <i>Rutilus rutilus</i> (L.)	+	+++	+++	+++	+++	
	5. Dace – <i>Leuciscus leuciscus</i> (L.)	+	+	++			
	6. Chub - <i>Leuciscus cephalus</i> (L.)	+	+	++			
	7. Orfe <i>Leuciscus idus</i> (L.)	+	+	++			
	8. Rudd – <i>Scardinius erythrophthalmus</i> (L.)	+	+++	+++		+++	
	9. Grass carp – <i>Ctenopharyngodon idella</i> (Val.) ●	+	+				
	10. Asp - <i>Aspius aspius</i> (L.)	+	+	+			
	11. Verkhovka – <i>Leucaspius delineatus</i> (Heck.)	+	+	+			
	12. Tench <i>Tinca tinca</i> (L.)	+	+++	+		+	
	13. Undermouth – <i>Chondrostoma nasus</i> (L.)	+	+	+			
	14. Stone moroco – <i>Pseudorasbora parva</i> (Temm. and Schl.) ●	+	+	+			
	15. Gudgeon - <i>Gobio gobio</i> (L.)	+	+	+++		+	
	16. White – finned gudgeon <i>Pomanogobio albipinnatus</i> (Lukasch)	+		+++			
	17. Bleak – <i>Alburnus alburnus</i> (L.)	+++	+++	+++	+		
	18. Bystranka – <i>Alburnoides bipunctatus</i> (Bloch) x			+			
	19. Silver bream - <i>Blicca bjoerkna</i> (L.)	+++	+++	+++	+		
	20. Bream – <i>Abramis brama</i> (L.)	++	+++	+++	+		
	21. White eye – <i>Abramis sapa</i> (Pall.)	+	+				
	22. Blue bream – <i>Abramis ballerus</i> (L.)	+	+	+			
	23. Vimba – <i>Vimba vimba vimba</i> (L.) x		+	+			
	24. Sabrefish - <i>Pelecus cultratus</i> (L.)	+++	++	+			
	25. Bitterlings - <i>Rhodeus sericeus amarus</i> (Bloch)	+	+	+++		++	
	26. Crucian carp – <i>Carassius carassius</i> (L.)	+	+	+	+	+	
	27. Golden carp - <i>Carassius auratus gibelio</i> (Bloch) ●	++	+++	+++	+++	+++	
	28. European carp – <i>Cyprinus carpio</i> L.	++	+	+			
	29. Silver carp – <i>Hypophthalmichthys molitrix</i> (Val.) ●	+++	+				
	30. Spotted silver carp – <i>Aristichthys nobilis</i> (Rich.) ●	+					
	V. Catostomidae	31. Bigmouth buffalo – <i>Ictiobus cyprinellus</i> (Val.)	+				
	VI. Cobitidae	32. Spiny loach – <i>Cobitis taenia</i> L.			+++	+	
		33. Loach – <i>Misgurnus fossilis</i> (L.)			+++	+	
VII. Siluridae	34. Wels - <i>Silurus glanis</i> L.	++	+	+			
VIII. Ictaluridae	35. Bullhead – <i>Ictalurus punctatus</i> (Raf.) ●	+++					
IX. Gadidae	36. Burbot - <i>Lota lota</i> (L.)	+	+	+			
X. Gasterosteidae	37. Nine spined stickleback – <i>Pungitius pungitius</i> (L.)	+	+	+			
	38. Three spined stickleback – <i>Gasterosteus aculeatus</i> L.	+	+	+			
XI. Percidae	39. Sander – <i>Stizostedion lucioperca</i> (L.)		+++	+++			
	40. Perch - <i>Perca fluviatilis</i> L.	+	+++	+++	+++	+++	
	41. Ruffe – <i>Gymnocephalus cernuus</i> (L.)		+	+	+++	+++	
	42. Don ruffe – <i>Gymnocephalus acerinus</i> (Guld.)		+	+			
XII. Gobiidae	43. Monkey goby – <i>Neogobius fluviatilis</i> (Pall.)	+++	+	+++			
	44. Tube nosed goby – <i>Proterorhinus marmoratus</i> (Pall.)	+++	+	+++			
	45. Round goby – <i>Neogobius melanostomus</i> (Pall.)	+	+	+			
XIII. Syngnathidae	46. Black striped pipefish – <i>Syngnathus nigrolineatus</i> (Eichw.)		+				

Note: + occurrence of different species +; low, ++; medium, +++; high,

●; species populated in reservoirs because of fishing measures; x; species carried in the list of rare fishes.

Cooling pond of Chernobyl NPP

Chernobyl NPP is situated in the eastern part of the natural region called Poles'e, which means “marshy woodlands”, at the bank of River Pripjat, emptying into Kiev Reservoir. The source of water supply for plant operation was the cooling pond that was made artificially along River Pripjat and located

at 1.5 km southeast from the power site.

The highest concentration of radionuclides, reaching 500 kBq/kg wet weight (w.w.) was registered in fish inhabiting the cooling pond in 1986. During the first months after the accident non-predacious fishes, feeding on zoo- and phyto-plankton, were the most contaminated, but later predacious fishes accumulated more radionuclides [5,6]. During the after-accident period the average concentration of radionuclides in silver carp decreased from 400 kBq/kg w.w. to 5 kBq/kg.

Aggregate dose for silver carp during the whole after-accident period reaches 10-12 Gy. Fish has absorbed the main part of irradiation dose, 7-8 Gy, during the first two years after the accident. In recent years internal dose was mainly obtained through intestine irradiation and amounted about 0.4 Gy per year, while internal dose for muscles averaged only 0.02 Gy per year (Fig. 2).

During special studies of reproductive organs of fish, different abnormalities in anatomy of gonads and morphology of reproductive cells have been found in silver carp. Gonad pathology included hermaphroditism, gonad asymmetry and other anatomical defect [7]. A number of fish, surviving the accident, had sterile gonads. Destruction of some amount of generative cells and contraction of generative tissue volume were registered in 48% of males. 35% of females had disturbances in oocyte morphology during vitellogenesis. In spite of various disturbances observed in generative organs, it was possible to obtain viable offspring from some fish in 1989-1990.

Silver carp, surviving the accident, could be easily bred, showing a high percentage of egg insemination and high survival rates for embryos, larvae and fry [8]. Anatomical abnormalities became apparent in the second and, especially, in the third year of life. There were curvature and length shortage of the dorsal or one of the pelvic fins, deformations of oral and gill structures, deformations of swim-bladder and epidermal neoplasia (*i.e.* tissue overgrowth) in anal region of females, forming a kind of genital papillae.

Ten individuals of silver carp, belonging to generation F₁₋₉₁, were analyzed in 1996 and only two mature carp have been found; a male and female. Unusual was the fact of their maturation at amazingly small size for this species; female was only 24 cm long, weighing 250 g, and a male was 31 cm long with a total weight of 461 g [9].

In 1991 during ichthyological survey of the cooling pond an abnormal young individual of tube-

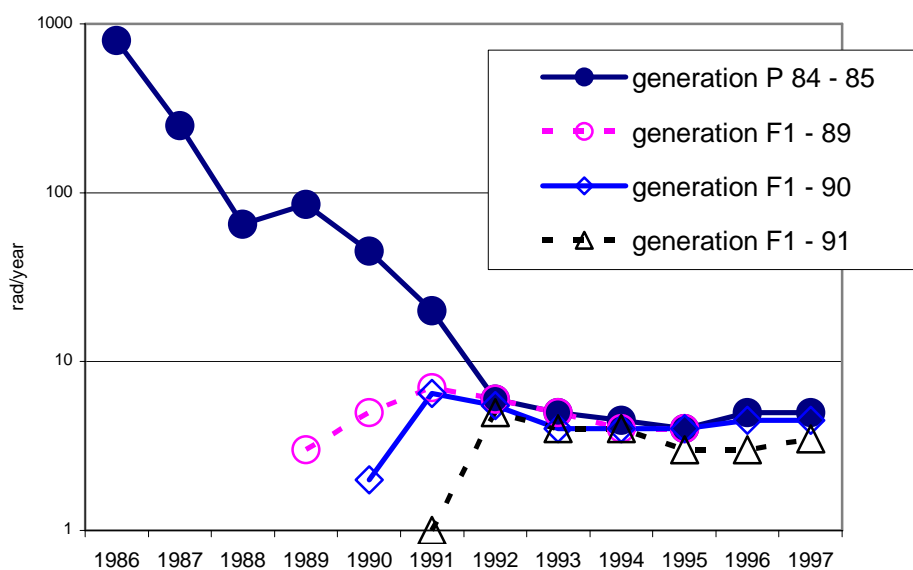

Fig.2. Internal committed dose for muscles of grass carp of different generations

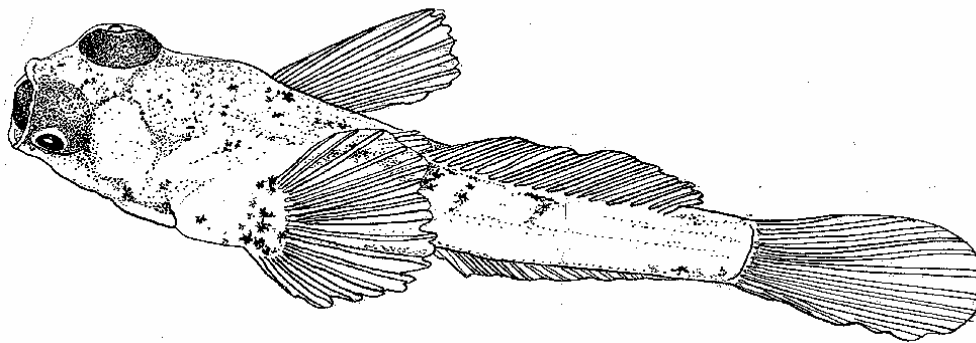

Fig.3. Abnormal fry of tube-nosed goby caught in the cooling pond of ChNPP (11.05.92).

nosed goby was found, having an eyeball developed inside the mouth cavity (Fig. 3). But the rest of the collected young fish of this species had no morphologic defects. During young fish collection in the cooling pond in 1992, a larval silver bream was found with spinal pathology and with primordial malformed pectoral fins. The larva was found among pondweeds and evidently could feed without swimming but keeping itself at the surface of weeds. It is obvious that individuals having such severe pathology cannot survive in the natural environment.

In spite of high dose rates during several years after the accident, no significant changes in fish community at population level have been observed. Comparison of the degree of abnormality in developing reproductive cells in both sexes reveals that structural damages are more pronounced in males than in females.

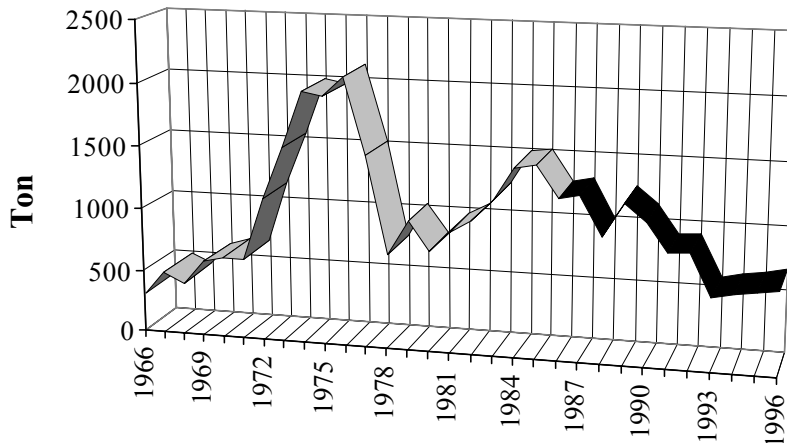

Fig.4. Dynamics of commercial catches in Kiev reservoir from 1966 to 1996.

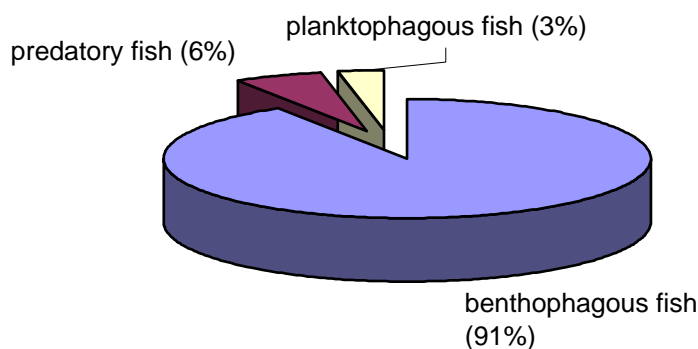

Fig. 5. Distribution of commercial fishes of Kiev Reservoir according to their food.

Kiev Reservoir

Kiev Reservoir is the first one in the Dnieper cascade into which run rivers Pripjat, Teterev and Uzh, flowing across the contaminated areas. During the after-accident period of 1986-1996, 10,245 ton of fish were harvested in Kiev Reservoir. Such benthophagous species as bream, roach, silver bream and European carp formed more than 90% of the total catch (Fig. 4, 5).

Radioecological monitoring of Kiev Reservoir revealed a decrease of ^{137}Cs concentration in muscles of predatory fish from 1500-2000 to 200-400 Bq/kg w.w. during 1987-2000 (Fig. 6, 7). But in the autumn of 2001, perches were met having 550 Bq/kg w.w. In muscles of non-predatory fish, constituting the bulk

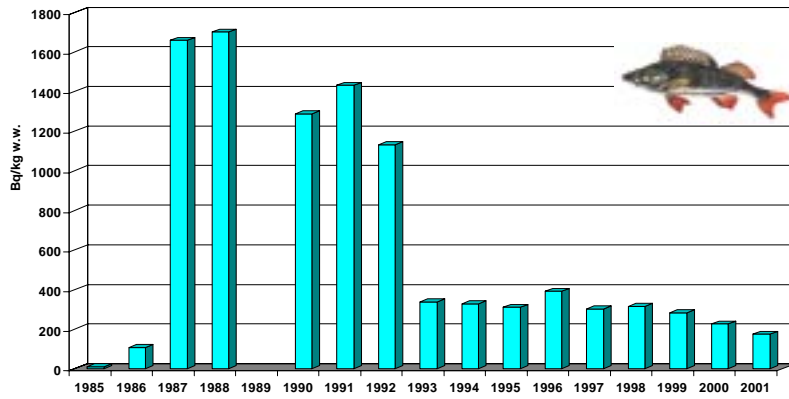

Fig. 6. Dynamics of Cs-137 accumulation in muscles of perch from Kiev reservoir

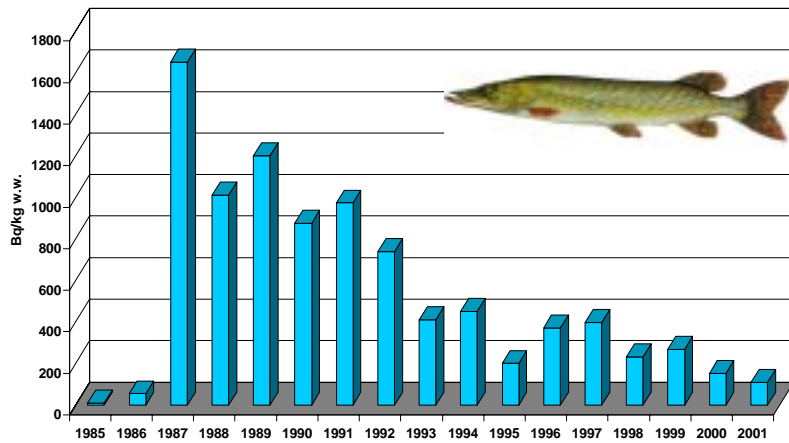

Fig. 7. Dynamics of Cs-137 accumulation in muscles of pike from Kiev reservoir

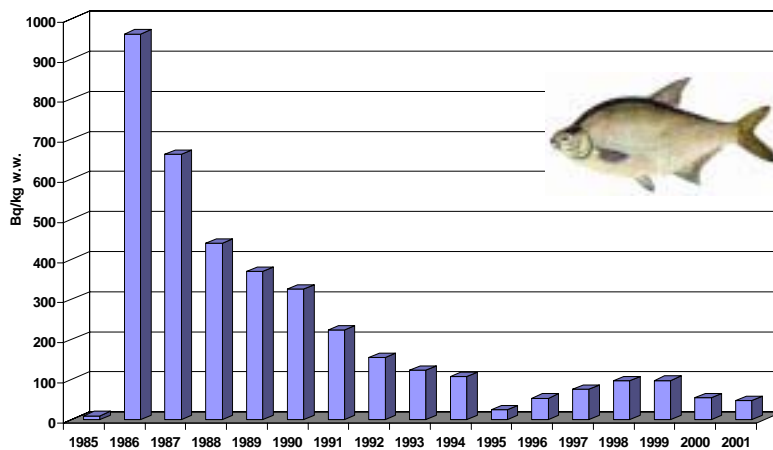

Fig. 8. Dynamics of Cs-137 accumulation in muscles of bream from Kiev reservoir

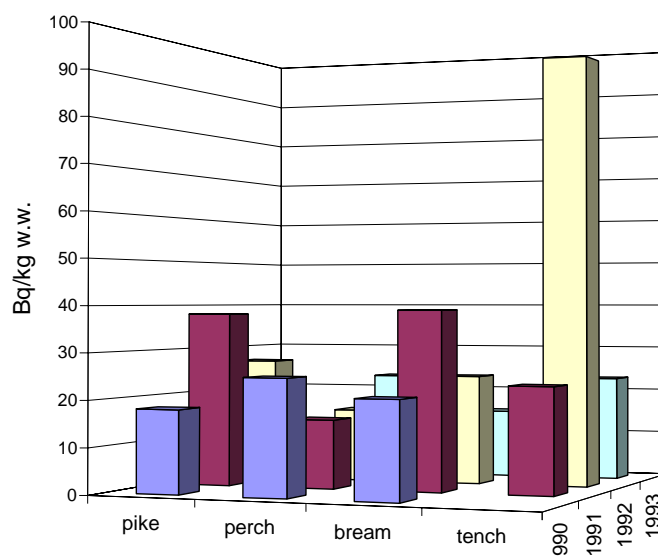

Fig. 9. Dynamics of Sr-90 accumulation in muscles of fish from Kiev reservoir

Table 3. The incidence of gonad malformations in pike females of different generations, (%).

Year of generation origin	Type of gonad malformations		
	Gonad asymmetry	Grain of roe resorption	Gonad hydration
1986	20.0	20.0	20.0
1987	33.3	0	16.6
1988	45.0	0	9.0
1989	0	0	0
1990	29.0	0	0
1991	46.0	23.0	0
1992	40.0	40.0	0
1993	65.0	10.0	0
1994	13.0	13.0	0
1995	33.0	22.0	0
1996	17.0	17.0	0

Note: the data on the before-accident generations are not cited because of their scarcity.

of commercial catch, bream for example, the concentration of ^{137}Cs was two-three times lower than in predators; pike and perch (Fig. 8). In the autumn of 2001, the highest figures for ^{137}Cs in bream muscles ranged between 40 and 70 Bq/kg w.w., averaging 55 Bq/kg.

Fishes of different trophic levels also accumulate in their muscles different amounts of ^{90}Sr , sometimes equivalent to 100 Bq/kg w.w. In 1991-1993 radionuclide concentration in muscles of bream, the main commercial fish species, ranged between 15 and 50 Bq/kg w.w. (Fig. 9).

In order to evaluate the biological effect of deposited radionuclides on fish from Kiev Reservoir, 209 pikes, belonging to 17 generations, have been analyzed during 1987-2000. Three types of abnormality in morphology of the reproductive system were registered: gonad asymmetry (34.1%), total resorption of eggs (12.5%) and gonad hydration (2.5%). Gonad asymmetry, the most common imperfection, was frequently accompanied by constrictions. There were instances that the weight difference between right and left gonad lobes was very high. Most frequently, this difference ranged from 1.5 to 3.0 times [10].

The first maximum in the number of malformations was observed in pikes born in 1986-1988. Another rise in malformation number was noted for the second after-accidental pike generation born in 1991-1993 (Table 3). In pike females, born before the accident in years 1982-1985, no gonad abnormalities was found, but one individual with asymmetric gonads, belonging to the generation of 1981, has been registered.

In 1986 internal dose from ^{137}Cs and ^{134}Cs for pikes in Kiev Reservoir was about 0.1 – 0.2 Gy, in 1993-1997 it decreased to 0.001 – 0.002 Gy per year.

Lake Kozhanovskoe

During water bodies monitoring in Bryansk region, scientists from Combined Radioecological Expedition of USSR Academy of Sciences in 1993 discovered abnormally high content of ^{137}Cs in fishes from Lake Kozhanovskoe. This lake, located at a distance of 210 km from Chernobyl NPP, has a square about 6 km², average depth of 1.5 m, maximum depth of 2.5 m. Lake sides are swampy and overgrown with coastal vegetation. Its bottom is covered with thick sapropel deposits. According to limnological classification, this lake may be attributed to eutrophic type. The concentration of K^+ in water varies from 2.6 to 2.7 mg/l during a year, and the concentration of Ca^{++} is from 24.6 to 44.3 mg/l. One liter of lake water during different seasons of 1993 contained ^{137}Cs activity from 6.1 to 8.5 Bq. The lowest index was registered in autumn. Seasonal measurements of pH showed the lowest figure for March (5.8) and the highest (7.7) – for autumn [11].

Eleven species of fish were registered in the lake. They were: pike, roach, bleak, silver bream, bream, crucian carp, golden carp, spiny loach, loach, perch and ruffe. Golden carp is dominating species. The concentration of ^{137}Cs in different fish species changed depending on their trophic level and size. The highest figure, equivalent to 70 kBq/kg w.w., was registered in 1993 for big pike, and the lowest, from 5 to 8 kBq/kg w.w., for ruffe and roach. The concentration of ^{137}Cs in muscles of golden carp, the main commercial fish species in the lake, ranged from 6.5 to 15.6 kBq/kg w.w., being 10.4 kBq/kg in average. The concentration of ^{90}Sr in this species varied between 160 and 530 Bq/kg w.w. with the average figure of 260 Bq/kg w.w. At the same time, in River Iput', very close to Lake Kozhanovskoe, the concentration of ^{137}Cs was almost 100 times lower.

According to the data of 2000, the content of ^{137}Cs in fish flesh was retained at the level of 1993, and for golden carp averaged at 8.14 kBq/kg w.w. Main factors, determining such high level of fish contamination with radionuclides in Lake Kozhanovskoe, are the high content of radiocesium in lake water and, accordingly, in feeding objects of fish, as well as low water exchange in the lake and the low content of K^+ in lake water.

Taking into account that the permitted level of ^{137}Cs content in fish products in Russia is 120 Bq/kg w.w. [12], it can be suggested with certainty that for such lakes as Kozhanovskoe with internal drainage, fish purification up to the permitted level will take 60-90 years, *i.e.* two-three half lives of ^{137}Cs and ^{90}Sr .

Analyses of gonad condition revealed that serious disturbances in gonad morphology were found only in predatory fish; pike and perch. In other species, like roach and golden carp, only small amount of germinal cells was damaged [13].

River Teterev

River Teterev flows across Kiev region of Ukraine at a distance about 80 km from ChNPP. Contamination of the river with radionuclides happened primarily by radioactive fallouts from the atmosphere just after the accident, and later, as a result of wash out of radionuclides from the contaminated river watershed. Ichthyofauna of lower reaches of the river, around settlement Oranoe, is very similar to that of Kiev Reservoir and includes 38 species. The river supports active but mainly illegal fishing by local peasants.

The highest indices of ^{137}Cs content during study period (1990-2001) were registered for predatory species; pike and perch. Monitoring of the contamination dynamics in pike revealed maximal levels of ^{137}Cs concentration in the first year of investigation in this region (1990) with the average value in muscles of 728 Bq/kg w.w. In the summer of 2001 this index became 7-8 times lower with the average figure of 90 Bq/kg w.w. (Fig.10).

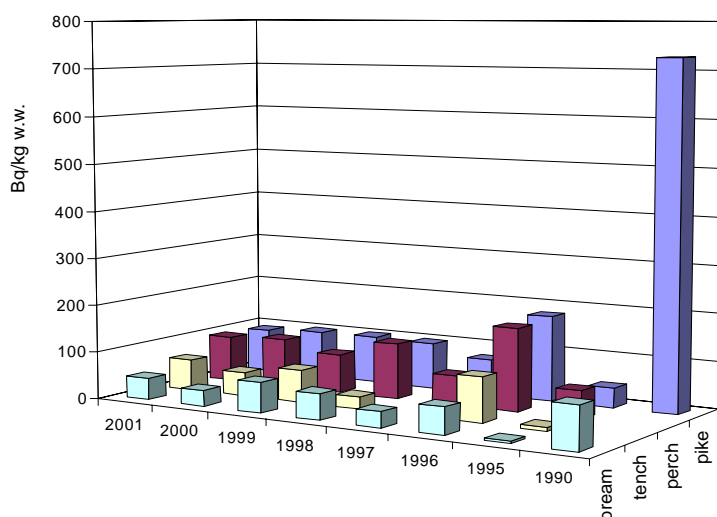

Fig.10. Average concentration of Cs-137 in different species of fish from river Teterev

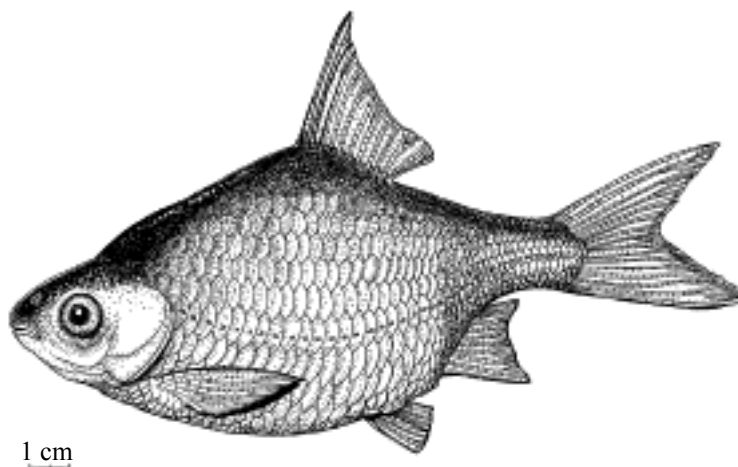

Fig.11. Abnormal roach from river Teterev, SL – 183 mm, age – 6+, caught in February 1998.

Several morphologically abnormal fish have been found during regular surveys of River Teterev. Four abnormal roaches were caught in 1998. One of them had unusual body proportions – caudal peduncle was very short, and relative body depth was almost twice higher than in normal fish (45% of standard length). The age of the fish was 6+ years and it represented, most likely, the second after-accident generation (Fig. 11). One more abnormal individual, aged 10+ had deformed scales. The rest two fish had anomalies in body proportion combined with damages of scales. One of these fish in its right pelvic fin had two more soft rays as compared with the left pelvic fin.

During next three years, 1999-2001 no more fish bearing morphological deformities were found in River Teterev.

Lake Svyatoe

Studies of this lake, situated in Mogilev region of Belarus, have been launched in 1997 [14]. It turned out that in this lake, located at the distance of 225 km from Chernobyl Power Plant, the concentration of ^{137}Cs in muscles of perch was equivalent to activity of 120 kBq/kg w.w. It was twice bigger than in muscles of predatory fish from lake Kozhanovskoe and 24 times higher than in muscles of fish from the cooling pond of ChNPP. Activity of ^{137}Cs in muscles of non-predatory fish such as roach and rudd achieved 15 – 20 kBq/kg w.w.; their average values are 15.3 and 14.8 kBq/kg w.w., respectively (Fig. 12). Maximum accumulated dose was found in perch to be 0.4 Gy per year.

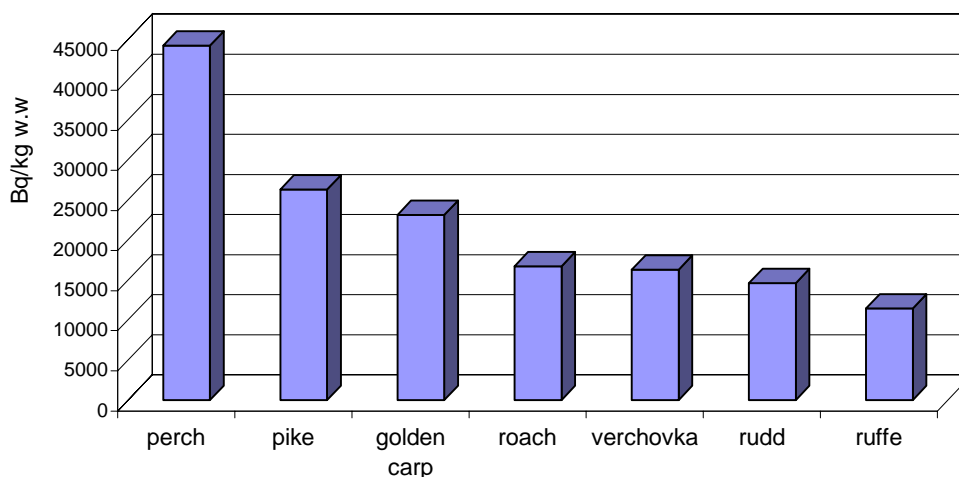

Fig.12. Average concentration of Cs-137 in different species of fish from Lake Svyatoye in May,1998

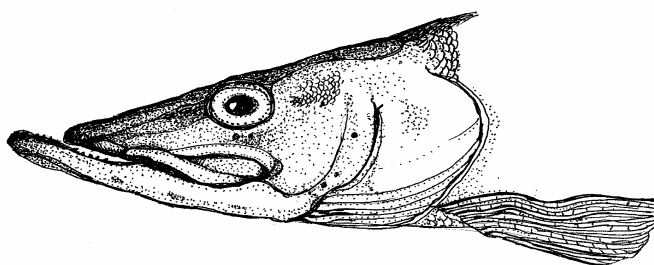

Fig. 13. Head of pike with deformed upper jaw and pectoral fin rays SL – 453 mm age – 4+. Lake Svyatoye, Mogilev region, Belarus, 16.05.98.

During fish survey of Lake Svyatoye in May 1998 only one pike was caught. It was four years old and had several anatomical defects: shortened upper jaw (Fig. 13) and four deformed rays in the left pelvic fin. Gonad imperfections included gonad asymmetry and constrictions in the right gonad. Calculated internal dose for this pike was 2.5 Gy for all its life. One of the reasons of morphologic deformities in the after-Chernobyl fish generations may be the phenomenon called “extended mutagenesis”. It means that mutations are manifested in the offspring of parents, subjected to some negative influence. In our instance, the initial impacts were given during the first days after the Chernobyl accident in 1986.

Conclusion

A considerable reduction of radionuclide content in fishes, inhabiting the most part of contaminated bodies of water, took place during 15 years, passing from the time of the Chernobyl accident. After 1993, the concentration of ^{137}Cs in flesh of fish, living in rivers and reservoirs, does not exceed 600 Bq/kg w.w. Only the cooling pond of ChNPP and some lakes in Russia and Belarus are the exception [15].

The rate of fish decontamination from radionuclides is connected with the initial amount of deposited radionuclides, and also with hydrology and hydrochemistry of the water body. Main reasons for the high concentration of ^{137}Cs in water, sediments and fish of Lake Kozhanovskoe are low content of K^+ in water and very slow water exchange. High level of contamination of this and some other lakes can last tens of years, decreasing only as a result of natural decay of ^{137}Cs with half-life about 30 years. Since the rate of natural decontamination of Lakes Kozhanovskoe and Svyatoye is very low, the process of fish decontamination or “purification” may also take several tens of years.

Predatory fish concentrate 2-3 times more ^{137}Cs than non-predatory ones; in the process of ^{90}Sr accumulation this effect of trophic level is not expressed so evidently.

Biological diversity of fish in water bodies contaminated as a result of the Chernobyl accident does

not show significant changes, but the abundance of some species, representing the highest trophic level, may decrease during the next 10-20 years because of disturbances in their reproductive system.

Considering the lack of proven practice and even any experience in rehabilitation of large fishery bodies of water such as rivers, lakes and reservoirs, there is a need in urgent development of scientific recommendations for safe and rational fishing and fish processing in contaminated bodies of water, with the help of international scientific community.

Acknowledgments

We would like to thank our colleagues from the ichthyological group of Combined Radioecological Expedition: N. V. Belova, L. I. Pel'gunova, N. I. Polyakova, N. V. Gemba, S. S. Gonchar, S. A. Smirnov, M. I. Molyukov, A. O. Kulikov, for their lasting many years help in collection and processing of the material.

REFERENCES

1. Atlas of Caesium Deposition on Europe after the Chernobyl Accident. M.DeCort et al., Eds., Office for Official Publications of the European Communities, Luxembourg, 1998.
2. Ryabov, I.N. (1992) Analysis of Countermeasures to Prevent Intake of Radionuclides via Consumption of Fish from the Region Affected by the Chernobyl Accident. *Proc. Int. Seminar Intervention Levels and Countermeasures for Nuclear Accident*, Commission of the European Communities Press, pp. 379-395.
3. Ryabov, I.N. (1992) Evaluation of Radioactive Pollution Impact on Hydrobionts in the 30 km Control Area of the Chernobyl Nuclear Power Plant. *Radiobiologiya*, vol. 32, pp. 662-667 (In Russian).
4. Kazakov, S.V. (1995) *Upravlenie radiatsionnym sostoyaniem vodoemov okhladitelei AES* (Management of Radiation Condition of Cooling Ponds at Nuclear Power Plants), Kiev: Tekhnika, p. 190.
5. Ryabov, I.N. (1990) The Ecological Fish Groups in the Chernobyl NPP Cooling Pond. *Int. Conf. "Biological and Radioecological Aspects of the Consequences of Chernobyl NPP Accident"*, Moscow, p. 121.
6. Ryabov, I.N., Koulikov, A. O. (1992) Specific Caesium Activity in Freshwater Fish and the Size Effect. In: *The Science of the Total Environment*, pp.125-142.
7. Belova, N.V., Verigin, B.V., Ryabov, I.N., et al., (1994) Radioecological Analysis of Silver Carp (*Hypophthalmichthys molitrix*) from the Cooling Pond of the Chernobyl NPP in the Post-Disaster Period. *J. Ichthyol.*, vol. 34, (4), pp.16-38.
8. Belova, N.V., Verigin, B.V., Yemel'yanova, N.G., et al. (1993) Radiobiological Analysis of Silver Carp (*Hypophthalmichthys molitrix*) from the Cooling Pond of the Chernobyl Nuclear Power Station in the Post-Disaster Period. 1. Reproductive System of Fish Exposed to Radioactive Contamination. *Voprosy Ikhtiologii*, vol. 33, (6), pp. 814-828 [*J. Ichthyol.* (Engl. Transl.), vol. 34 (4), p.16].
9. Belova, N.V., Emel'yanova, N.G., Makeeva, A.P., Ryabov, I.N. (1998) Unique Example of Dwarf Silver Carps Registration. *Vopr. Ikhtiol.*, (Moscow), vol. 38 (4), pp.839-843 (In Russian).
10. Polyakova, N.I. (2001) Radioecology of Pike, *Esox lucius* in Kiev Reservoir after the Chernobyl Accident. *Vopr. Ikhtiol.*,(Moscow), vol. 43 (6), pp. 391-398 (In Russian).
11. Ryabov, I.N., Belova, N.V., Haddingh, R.H., et al. (1996) Radioecological Phenomena of the Kojanovskoe Lake. *First Int. Conf. European Commission, Belarus, Russian Federation and Ukraine on the Radioecological Consequences of the Chernobyl Accident*, Minsk, pp. 213-216.
12. Standards of Radiation Safety, Moscow, Minzdrav, 1999.
13. Belova, N.V., Emel'yanova, N.G., Makeeva, A.P., Ryabov, I.N. (2001) Condition of Reproductive System in Fish From Lake Kozhanovskoe (Bryansk region), Contaminated with Radionuclides as a Result of Chernobyl Accident. *Vopr. Ikhtiol.* (Moscow), vol. 41 (3), pp. 358-367 (In Russian).
14. Ryabov, I.N. (1997) The Radioecological Consequences of Chernobyl Accident for Fish. *Radiobiology and Radioecology*, vol. 37, pp. 657-663 (In Russian).
15. Smith, J.T., Kudelsky, A.V., Ryabov, I.N., Haddingh, R.H. (2000) Radiocesium Concentration Factors of Chernobyl Contaminated Fish: a Study of the Influence of Potassium and "Blind" Testing of a Previously Developed Model. *J. Environm. Radioactivity*, vol. 48, pp. 359-369.

EPR Dosimetry of Chernobyl Liquidators

Vadim CHUMAK

*Scientific Center for Radiation Medicine, AMS Ukraine, Kyiv
04050 Melnikova, 53, Kiev, Ukraine: chumak@leed1.kiev.ua*

Abstract

The paper is devoted to review of development and application of EPR dosimetry with teeth in Ukraine. It deals with specific features of the EPR dosimetry protocol, which was developed and is practically used in SCRM for retrospective dosimetry of clean-up workers (liquidators). Extensive methodological research was conducted in SCRM in order to develop an original version of EPR dosimetric protocol as well as to investigate the effects caused by confounding factors and develop approaches to their account and mitigation. The proposed EPR dosimetric protocol addresses the demand for high accuracy and reproducibility, low sensitivity threshold as well as high throughput of the technique. High qualities of SCRM version of EPR protocol were proven in the course of elaborate quality assurance program, which included a series of international intercomparisons. Creation and continuous operation of the nationwide tooth acquisition network is another key to the success of EPR dosimetry in Ukraine.

Particular attention in the paper is paid to definition of the most optimal way of application of EPR dosimetry for dosimetric support of the post-Chernobyl medical follow-up. The main applications of EPR dosimetry in Ukraine are both routine high precision reconstruction of doses to Chernobyl clean-up workers and the use of EPR dose estimates as a reference dose for validation of other retrospective dosimetry techniques. The latter proved to be the most efficient application of EPR dosimetry in the post-Chernobyl situation. EPR dosimetry was used for testing such methods of retrospective dosimetry as FISH, ADR, SEAD and RADRUE. Nowadays EPR dosimetry plays inevitable role in dosimetric support of the post-Chernobyl medical follow-up studies.

Introduction

The Chernobyl accident and obvious failure of routine dosimetric monitoring of clean-up workers (liquidators) had stimulated significant development of various methods of retrospective dosimetry. Among those methods one of the most adequate proved to be an EPR dosimetry with teeth. Over last decade EPR dosimetry made all way from unique experimental technique to the tool of routine dose reconstruction. Many different applications are known for EPR dosimetry with teeth. It was used for determination of doses received in course of radiotherapy [1], dose reconstruction for atomic workers [2] as well as in several cases of accidental exposure [3-7]. In recent years, several review papers [8-11] and one book [12] were published dealing with various aspects of EPR dosimetry. Notable role in the process of development and implementation of this method belongs to the research performed in Scientific Center for Radiation Medicine (SCRM) AMS Ukraine, in particular to the work performed in collaboration with leading laboratories worldwide [8, 13-21].

This paper is dealing with some specific features of the EPR dosimetry protocol which was developed and is practically used in SCRM, briefly touches results of investigations performed in this institute, and concentrates to a larger extent on practical applications, which EPR dosimetry had found in Ukraine. Particular attention in the paper is paid to definition of the most optimal way of application of EPR dosimetry for dosimetric support of the post-Chernobyl medical follow-up.

1. Methodological aspects of EPR dosimetry with teeth

1.1. EPR dosimetric protocol, SCRM version

In general, any version of EPR dosimetric technique comprises several distinctive steps or stages. This includes collection of samples, sample preparation, recording and decomposition of EPR spectra, determination of cumulative dose and assessment of accidental exposure component, and assessment of uncertainty. It should be stressed that presently no single standard EPR technique exists. Combination of particular solutions concerning each element of this technique determines unique protocols, which are practiced in each individual laboratory. Herewith we will briefly discuss an EPR dosimetric protocol, which was developed and is being routinely used in SCRM AMS Ukraine. This protocol in more details is described elsewhere [13]. The aforementioned sequence of steps as well as peculiar features of the SCRM protocol are schematically presented at Fig.1. In may be seen, that quite significant modification were introduced into the generic scheme of EPR dosimetry with teeth. In our presentation we will follow the logical scheme as presented at Fig.1.

Collection of samples. Sample collection is an inevitable element of EPR dosimetry with teeth. Obviously, due to ethical considerations, extraction of teeth solely for dosimetric purposes is impossible. Therefore, only teeth, which are being extracted by medical prescriptions in the course of routine dental practice, may be collected and used for retrospective dosimetry. This consideration substantially reduces possibility to obtain dosimetric bioporobes (teeth) from the subjects, which are significant from the point of view of follow-up and thus dose reconstruction. Moreover, it should be taken into account that even sound molar contains only about 300-500 mg of enamel, while in practice significantly damaged teeth are extracted, having, respectively, much less enamel.

Obviously, teeth of Chernobyl clan-up workers are the unique and unrecoverable resource. The problem may be solved by organizing and operation of a widespread network for collection of teeth (desirably - all!), which are extracted by medical prescriptions from the liquidators. In order to secure collection of teeth from maximum number of exposed individuals, tooth collection network branches were established in 7 oblasts (regions) of Ukraine, which have the highest liquidator population. The structure of this network and respective flow-chart are presented at Fig.2. The teeth collected in various dentistry clinics within the given oblasts are collected in the regional hub and then, periodically, are forwarded to

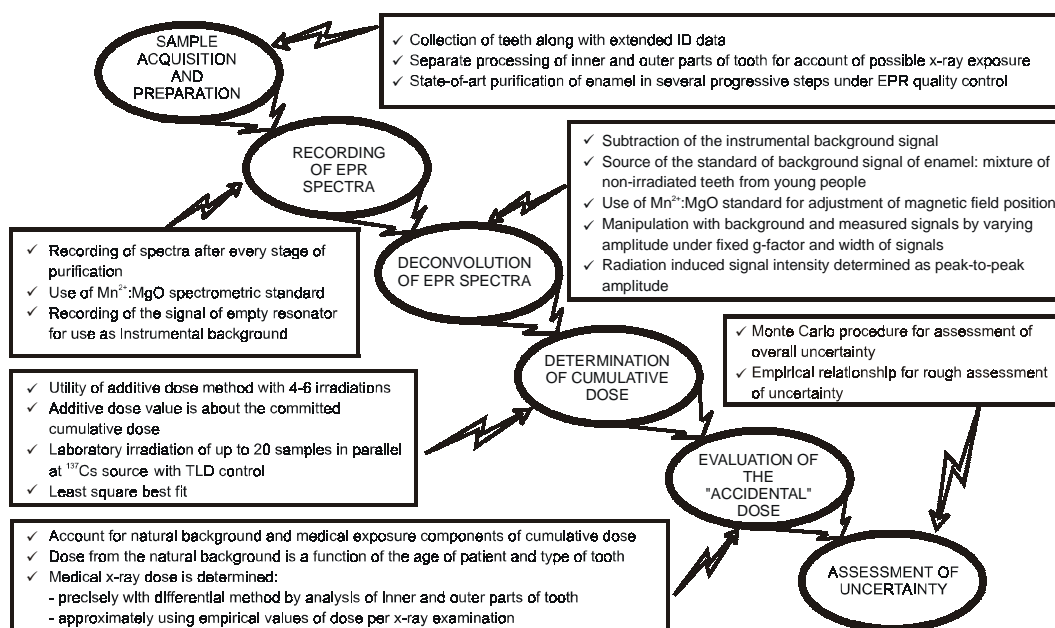

Fig.1. SCRM version of EPR dosimetric protocol.

Kiev to the central bioprobe bank. Here the collected teeth are registered and logged into a database, and, after input inspection and estimation of quality, are placed into the bank for long-term storage. Later, upon specific request, some samples are retrieved from the storage and are used for dose reconstruction. The results of EPR dosimetry are used in a number of occasions - more detailed discussion of application areas for EPR dosimetry is given below. In principle, as depicted in Fig.2, routine dose reconstruction could be performed in several accredited EPR laboratories. However, so far such routine dose reconstruction is performed in only one institution, namely Scientific Center for Radiation Medicine AMS Ukraine.

Since reconstruction of individual doses is concerned, some personal data need to be acquired in the course of tooth collection. This is achieved by filling out a special ID form, so called "Tooth passport". This form consists of three main sections. First of all, contact and personal data is registered, allowing to identify the tooth donor and, if needed, reestablish personal contact with him. Respectively, the first section includes the name of the clinics where the tooth was extracted and registration number of a person, full name, year of birth and year of clean-up work in Chernobyl as well as contact telephone number(s). In the second section of the tooth ID form all instances of lifetime exposure, both occupational and medical are recorded. The third section contains characteristics of the extracted tooth, in particular its position in a mouth and reason of extraction (diagnosis). Passport of tooth is filled out by a dentist prior to extraction of tooth and it accompanies the sample until it arrives into the central bioprobe bank and passes check-in to the respective database. In the course of practical collection of teeth the tooth ID form was substantially modified, being reduced only to the most essential entries. It was demonstrated that any additional information could be acquired, if needed, by the secondary contact with liquidator.

Although legal grounds for establishment of the tooth acquisition network were laid in 1997, this effort came to active phase in 1999, when appropriate funding was put in place. In 2001 the network was expanded, incorporating two more oblasts of Ukraine, increasing their count to seven. In total, since the beginning of operation of the tooth acquisition network, about 4000 teeth were collected and checked into

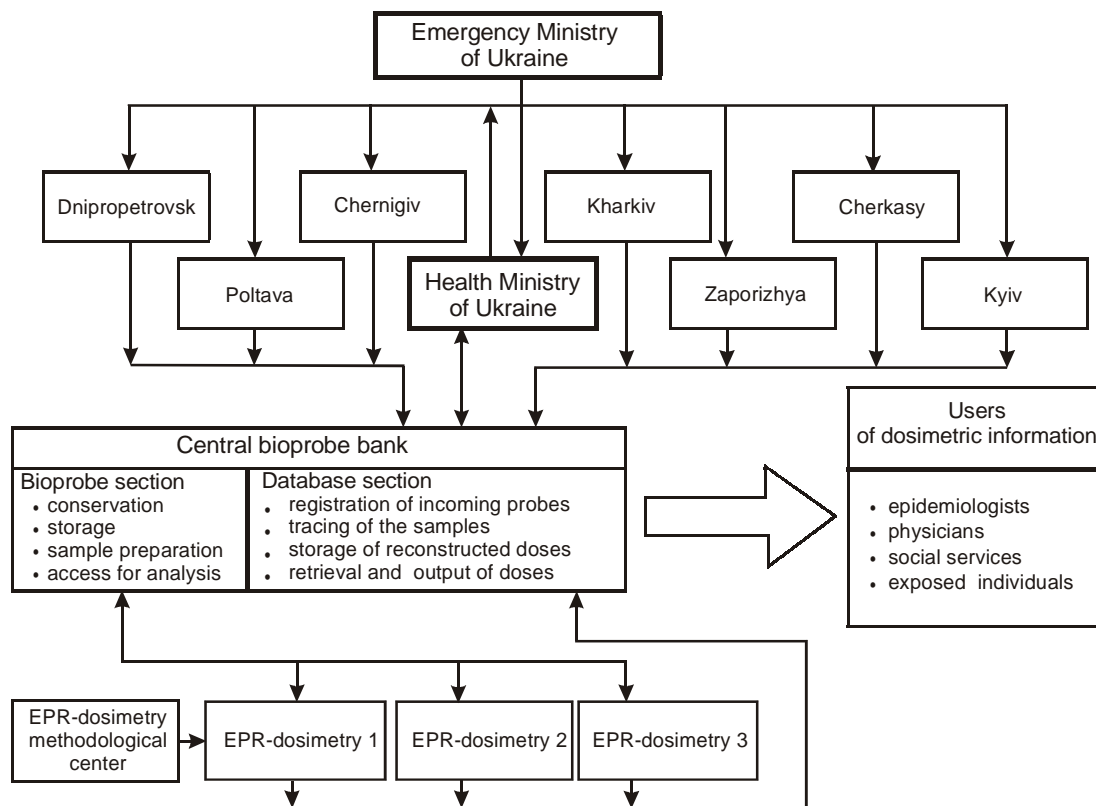

Fig.2. Structure and operation flowchart of the tooth acquisition network in Ukraine.

Table 1. Quality grades of teeth and percentage in the pool of collected samples.

Grade	Characteristics of a tooth	Applicability for EPR dosimetry	Percentage in the pool of collected teeth
1	Tooth roots (including fragments), enamel is absent	Not applicable	24
2	Insufficient amount of enamel (10-20%), teeth under metal crown	Practically not applicable	11
3	Incisors, canines	Practically not applicable	17
4	Molars and premolars with 20-50% of enamel	Applicable if dose is high	10
5	Molars and premolars with more than 50% of enamel	Applicable, could be limitation in terms of separate buccal and lingual part analysis	21
6	Intact crown and root	Unlimited applicability	17

the bioprobe bank.

Intermediate and long-term preservation and storage of teeth is a separate issue. Study of various storage media (ethanol, formaldehyde, Nikiforov's mixture - 50% alcohol+50% ether) had revealed that from the point of view of biological decontamination, pre-treatment of enamel and absence of destructive effect on EPR spectra, the most appropriate medium is Nikiforov's mixture. However, from the practical point of view, use of liquid storage media is quite difficult, requiring supply of robust vials, ready solutions and complicated transportation of the collected samples. Therefore for operation of the widespread tooth acquisition network the simplified pre-storage protocol was proposed. According to this protocol, extracted tooth is washed and disinfected in formaldehyde, rinsed in large amount of tap water, and then dried at room temperature and sealed in a paper envelope with the tooth ID form being stapled to it. It was demonstrated that a sample processed in such manner is being dried to the appropriate degree on the way to the central bioprobe bank. According to Ukrainian legislation, extracted teeth are not considered as human organs or sources of biological hazard - this significantly simplifies the legal aspects of the described procedures.

Obviously, there are certain aspects, which are significant from the point of view of dose reconstruction, in particular amount of available enamel or position of tooth (front teeth are not usable for dose reconstruction due to large and uncontrollable contribution of solar UV exposure into dosimetric signal. In order to formalize qualitative evaluation of incoming teeth and facilitated retrieval of appropriate samples from the bioprobe bank, a ranking system was designed in SCRM. All teeth are assigned with certain grades according to their status. The ranking criteria as well as distribution of the collected samples by the quality grades are presented in Table 1. One may see that only about half of collected samples have grades-4 to -6 and thus are appropriate for dose reconstruction; the highest grade - 6 have only about 17% of collected teeth and therefore only these samples are good for high precision dose reconstruction using two halves of a tooth and detection of lifetime x-ray irradiation.

Upon incoming registration, each of the samples is examined and the grade is assigned. This information is recorded in the database, significantly facilitating subsequent use of the collected material. For instance, in the course of high precision dose reconstruction needed for provision of reference quality dose estimates, only teeth having grade-6 are pulled from the bioprobe bank and used for EPR dosimetry. In general, the system of formalized quality assessment of the collected samples proved to be very efficient instrument for management of the bioprobe bank and sensible use of collected teeth.

Sample preparation. If reconstruction of low doses (below 0.5 Gy) is concerned, sample preparation plays the key role. As shown in Fig.3, for doses below 0.5 Gy dosimetric signal appears as quite small

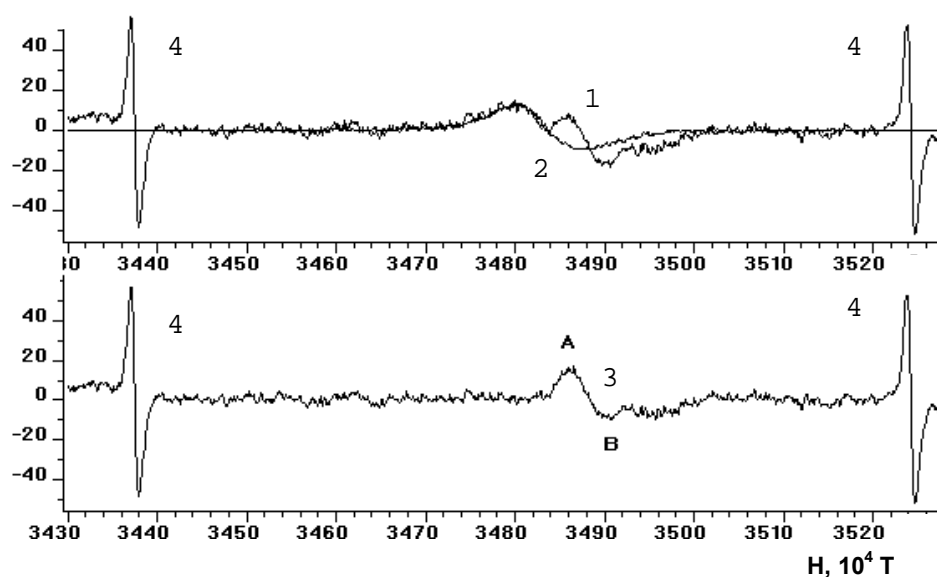

Fig.3. Typical EPR spectrum of tooth enamel exposed to dose 0.8 Gy.

- 1 - recorded (original) spectrum
- 2 - standard signal of native (background) signal
- 3 - dosimetric signal (difference of 1 and 2)
- 4 - lines of $\text{Mn}^{2+}:\text{MgO}$ spectrometric standard, used for calibration of g-factor and intensity of EPR signals
- A - first maximum of dosimetric signal
- B - first minimum of dosimetric signal

addition to the more intense background (native) signal. Obviously, improvement of this "signal to noise" ratio is an effective way of enhancement of the sensitivity of the method. Basically, this may be achieved by purification of the sample and reduction of the background signal

It is known that dosimetric signal is associated with mineral component of tooth, while native signals are usually associated with organic component of tooth. In fact, the ratio of mineral to organic components in enamel and dentine is 95:5 and 70:30, respectively. Therefore, rigorous separation of enamel from dentine is one of the key issues in the sample preparation process. The most straightforward method is mechanical removal of softer dentine from the tooth crown using hard alloy dental drill. Although this approach is widely used [22-25], it is not perfect. First of all, this method is extremely labor intensive and has relatively low throughput. High skills of operator are required for efficient removal of dentine from the curvatures of inner surface of dental crown. In addition, one should be aware of possible artifacts which could be introduced by local overheating of enamel due to high speed drilling or generation of unwanted EPR signals if UV illumination is used for visualization of dentine inclusions [26-28]. After all, the resulting purification of the sample depends on the skills of an operator, complicating thus standardization of sample preparation procedure.

Alternative approach to the purification of enamel is based on chemical treatment of the samples. This approach was perfected and brought to the state-of-the-art level in SCRM [13]. The flow chart of this procedure is presented in Fig.4. Essentially this is multi-stage technique; each progressive step is used if the previous operation failed to provide the desired quality of the sample. The quality of purification achieved after each individual step (Fig.4) is objectively controlled by means of EPR spectroscopy - if EPR spectrum demonstrates presence of the signals from impurities, the sample is subjected to the next step (degree) of processing. It should be mentioned that chemical processing with alkali solution (KOH or

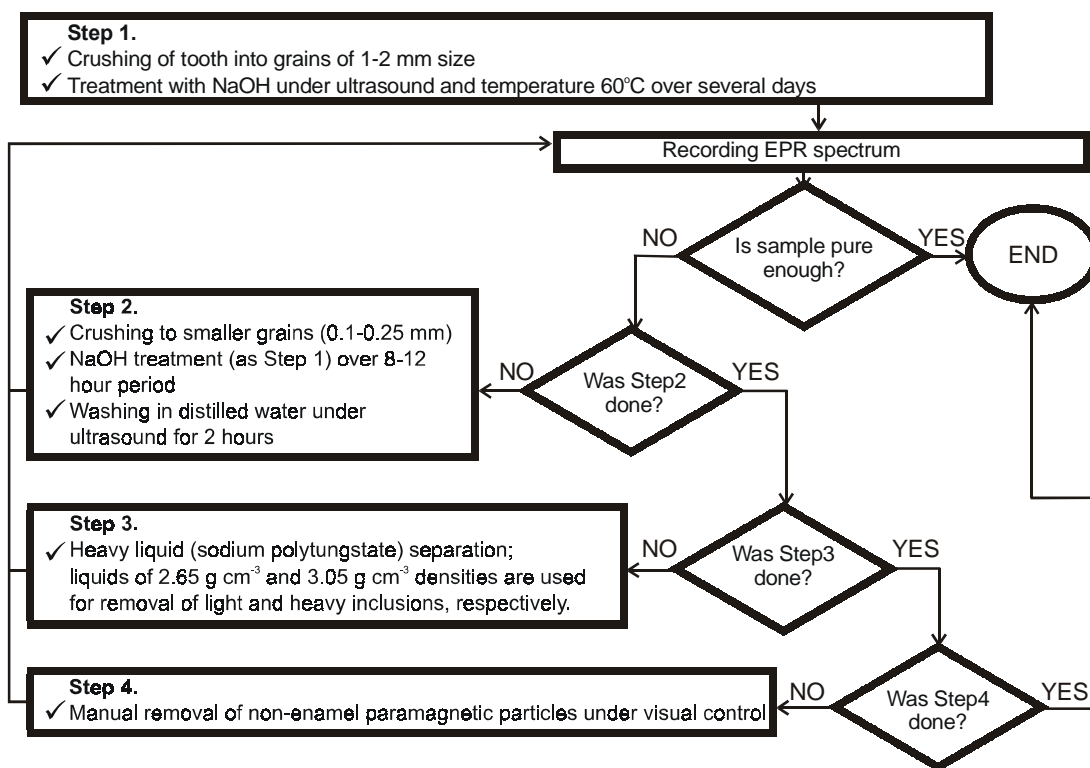

Fig.4. Flowchart of the SCRM sample preparation procedure.

NaOH) is conducted with ultrasound and enhanced temperature (60° C) applied to a solution. Simultaneous processing of many samples using the same ultrasonic bath as well as extremely low labor intensity are the strong sides of this operation. The process of chemical separation may last up to several days; alkali solution in the tubes is changed several times over duration of the treatment until no white sediment is created anymore. As a variant, big pieces of enamel after mechanical removal of dentine may be subjected to this treatment. In case if steps 1 and 2 (Fig.4) turn to be inefficient, heavy liquid separation of non-enamel inclusions should be applied. This process makes use of difference in specific weight of enamel (2.9-3.05 g cm⁻³) and foreign inclusions. In our practice we use non-toxic water solution of sodium polytungstate (Na₆(H₂W₁₂O₄₀)H₂O), which is quite flexible in terms of variation of a specific weight. In some (in fact, very rare) cases when all three stages of sample purification are not successful, manual removal of inclusions could be performed under visual control.

The described procedure of sample preparation has high throughput and possesses high degree of standardization - both features are extremely important when bulky dose reconstruction is concerned. In fact, low labor intensity and high throughput are achieved due to parallel processing of a large number (several dozens) of samples and multistage protocol, while higher stages of purification are applied to some samples only when needed.

It also should be mentioned that, in the latest version of the SCRM dosimetric protocol, buccal and lingual parts of a tooth are prepared and measured separately in order to allow determination and account of possible lifetime x-ray exposures. With low speed diamond saw the buccal and lingual planar pieces are cut from the tooth crown (Fig.5). The following purification of enamel from these plates is performed according to the above-described procedure. As a result, it is possible to perform dose reconstruction separately for buccal and lingual parts of tooth and subsequently evaluate the contribution of x-ray irradiation.

Registration of EPR spectra. This step of the EPR dosimetric protocol (see Fig.1) is performed using X-band spectrometer BRUKER ECS-106 with registration parameters which are de facto standard in EPR

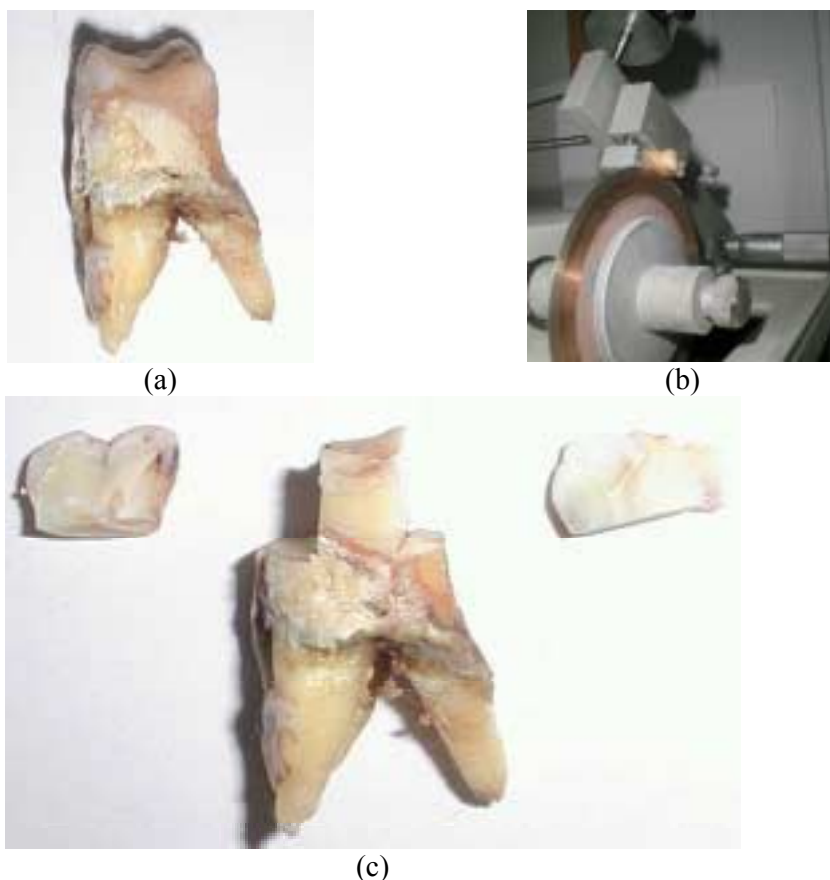

Fig.5. Cutting of a tooth to buccal and lingual parts using low speed diamond saw.

- a - original sample
- b - process of cutting
- c - result of cutting

dosimetry with teeth [21]. The unique feature of the SCRM protocol is a use of programmable goniometer, which proved to be extremely efficient tool for elimination of sample anisotropy [29]. In order to secure reproducibility of the results, spectrometric standard $Mn^{2+}:MgO$ is used for both calibration of g-factor and intensity of EPR signal.

Spectra deconvolution. The spectra deconvolution (see Fig.1) is performed according to the spectrum subtraction method in which the EPR spectrum of a non-irradiated reference sample is subtracted from the spectrum of the irradiated sample [24, 30-33]. In case of SCRM protocol, the reference sample is prepared from homogenized enamel material collected from teeth of several young adults [13, 30]. In addition, a spectrum of empty tube is subtracted in order to minimize the effect of low frequency noise signals and enhance thus the accuracy and reproducibility of low dose measurements. The "classical" version of SCRM protocol [13] included manual spectra manipulation and subtraction. Recently an automated procedure for spectra decomposition was developed and implemented. The result of spectrum decomposition step of the protocol (Fig. 1) is the amplitude of the dosimetric signal in tooth enamel.

Evaluation of cumulative dose. The next stage of the technique is evaluation of the cumulative dose received by the tooth (enamel). This procedure makes use of the fact that in a wide range of exposures, intensity of the dosimetric signal linearly depends on the absorbed dose. However, the slope of calibration curve (i.e. dependence "dosimetric signal vs. dose") and, sometimes, its shape depend on individual properties of the particular sample. According to our experience based on analysis of several hundreds teeth, individual variability of radiation sensitivity is about 15%. Moreover, about 5% of the samples demonstrate non-linearity of calibration curve in the low dose range. Lack of account of the latter effect

may lead to significant under- or overestimation of dose. Therefore, in the SCRM dosimetric protocol individual calibration of radiation sensitivity is performed using the additive dose technique [12, 34]. Additional irradiation of the samples is performed using calibrated ^{137}Cs source with accuracy not worse than 3%.

In fact, application of the additive dose method has certain pros and cons comparing to the method of universal calibration coefficient (application of single coefficient for all samples) [20, 21, 24]. The strong sides of the additive dose method are discussed above, while its shortcomings are attributed to higher labor intensity caused by the need for repetitive irradiation sessions and EPR spectrum recording. Another disadvantage is caused by destructive nature of the additive dose method - dosimetric information in the enamel is altered after additional irradiation and the sample cannot be reevaluated in later time. In the practice of SCRM, higher labor intensity is deliberately accepted for the sake of much higher precision of dose reconstruction. From the point of view of destructive nature of additive dose method, a compromise may be achieved by calibration using only small part of the available sample [35]. According to this approach, a small piece (several mg) of enamel is exposed to high dose (about 10 Gy) in order to assess the slope of calibration line. Therefore, this method allows to address the problem of variation of radiosensitivity of individual samples at the cost of moderate additional labor. At the same time, one need to keep in mind that this simplified additive dose method does not address the question of possible non-linearity of dose response curves. In routine dose reconstruction of doses in SCRM we use universal calibration coefficient during screening of incoming samples and then one of the discussed versions of the additive dose technique is used for precision dose reconstruction.

If the additive dose method is concerned, quite important issues are related to the choice of irradiator and the mode of additional irradiation: number of irradiations and dose increment.

Due to significant energy dependence of EPR response (at low energies the intensity of dosimetric signal may be up to seven-fold to the respective signal caused by high energy exposure with the same dose), additional irradiation should be performed by the source with the energy similar to the energy of the concerned accidental exposure. In case of Chernobyl exposure, average energy of gamma exposure was about 500 keV [36] and, therefore, ^{137}Cs source (662 keV) is optimal for additional irradiation of the studied samples. In order to provide the balance of secondary electrons, irradiation should be performed behind the layer of a build-up material. In our practice we use 8 mm PMMA plate; special investigation had revealed that under such conditions the balance of secondary electrons is achieved while attenuation of incident beam is still small. The irradiation protocol [37] assumes 4-6 additional irradiations with variable increment of dose in order to obtain sufficient number of points in the region of possible non-linearity of dose response curve. One of the options is to start irradiation with dose about the expected accidental dose, doubling dose increment for each following irradiation.

In order to assess the uncertainty of cumulative dose evaluation, the stochastic modeling [38] is used, allowing to account the uncertainties of dosimetric signal evaluation and the accuracy of the dose of additional irradiation. Specialized software was developed for this purpose in SCRM [37].

Evaluation of accidental dose and its uncertainty. Once the cumulative dose is determined, the next step (Fig.1) is expressed in evaluation of the accidental dose - a component of cumulative dose caused by the concerned event of accidental or occupational exposure. One should remember that the cumulative dose is also formed by the components related to the natural background exposure, medical x-ray exposure and solar UV exposure. The first component could be easily assessed knowing the age of extracted permanent tooth (which is less than the age of the person and varies for different kinds of teeth). Two latter components are less definitive and act as confounding factors in EPR dosimetry with teeth (see Section 1.2). One of the most serious problems in EPR dosimetry is related to the effect of medical x-ray exposure. Development of approaches to its account and mitigation became possible after fulfillment of large cycle of a research, which is briefly discussed in Section 1.2. The problem of UV exposure is

addressed now by exclusion of the front teeth (incisors and canines) from consideration. Although this measure reduces the pool of available samples, lack of this consideration may result in severe distortion of dose assessments.

Comprehensive discussion of different sources of uncertainty and approaches to their evaluation is given elsewhere [39]. Here we will limit the discussion to a statement that, in general, overall uncertainty of SCRM technique depends on possible contribution from x-ray diagnostics. In the case, when x-ray component of dose is not present in the tooth, uncertainty (2σ) is ca.30-40 mGy. In the case when x-ray component is present, uncertainty could be as high as 60-80 mGy.

1.2. Study of confounding factors

A good deal of research was devoted to the study of confounding factors and development of approaches to their account and mitigation. Limited volume of this paper does not allow us to present these results in depth. We just mention that among those studies were investigations of the effect of crushing enamel and grain sizes [17], UV exposure [18] and, in particular, medical x-ray exposure [19, 40]. The last included a large cycle of both theoretical and experimental studies. Among others we did Monte Carlo simulations of depth dose profiles for idealized enamel slabs, whole isolated teeth [40] and teeth placed in the head of mathematical phantom. Experimental research was concentrated on reproduction of geometries and conditions of exposures, which were modeled mathematically. In addition various types of x-ray examination (both dental and thorax) were simulated using ALDERSON type heterogenic antropomorphic phantom (Fig.6). It was demonstrated that x-ray examination of a torso has negligible contribution to the dose to teeth (not more than 0.2 mGy), while dental x-ray examination may lead to high doses (up to 70 mGy) in enamel. It was shown that doses to teeth strongly depend on the type of examination (local vs. panoramic) and the hardware used for this examination. At the same time, in all cases pronounced depth profiles were observed in the studied teeth. These observations suggested

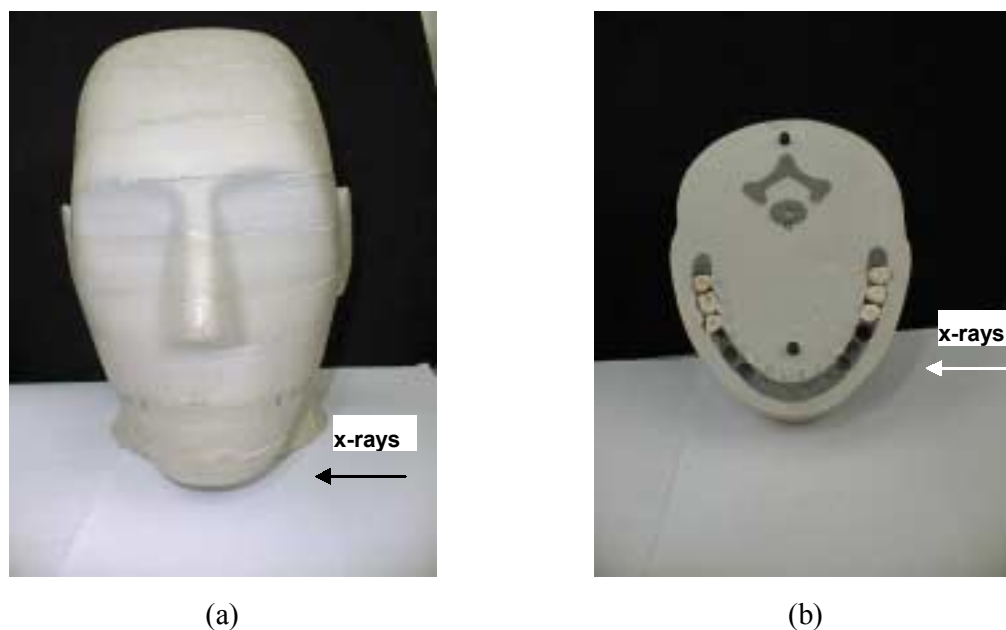

Fig.6. Geometry of simulation of local dental x-ray examination:

a - exterior view of the ALDERSON type phantom head

b - section of phantom at jaw level with whole teeth placed in 6-8 positions.

rejection of our original approach to account of x-ray dose (assessed as a product of number of examinations and dose per examination) and transfer to the approach based on separate analysis of buccal and lingual parts of a tooth and observation of dose gradient. The modern version of the SCRM EPR protocol requires the use of such separate analysis of two parts of a tooth in order to evaluate medical x-ray dose based on the results of this analysis.

1.3. Quality assurance program

Since EPR dosimetry is a relatively new method, which is still in the phase of establishment, particular attention needs to be paid to quality assurance of the results and check of reliability of the method. In order to ensure high quality of the results obtained in SCRM, an elaborate quality assurance program was developed and implemented. Besides regular internal tests and verification of calibrator source (the calibrator is traceable to IAEA laboratory of secondary standard in Siebersdorf), SCRM took part in a series of bilateral and multilateral intercomparisons. It is generally accepted that intercomparison is the most efficient mechanism for straightforward evaluation of quality of a radiation measurement method.

From the point of view of its design, all intercomparisons fall into three groups:

- intercalibration on the average samples of tooth enamel with uniform properties; 1st International Intercomparison [20] including 9 laboratories from 6 countries was performed according to this plan;
- intercomparison using whole teeth exposed *in vitro*; the 2nd International Intercomparison [21] with 20 participants and two bilateral intercomparisons were performed in this way [41];
- intercomparison using whole teeth exposed *in vivo*; one bilateral test was performed with Center of Applied Dosimetry of Utah University (USA), in which the actual teeth from liquidators were used [42].

All intercomparisons were performed as blind tests, e.g. nominal dose values were not known to the participants.

Fig.7 depicts the results of SCRM lab, which were demonstrated in the most recent intercomparison (bilateral test using whole teeth irradiated *in vitro*). One may see that in the whole range of doses, SCRM EPR dosimetry protocol [13] performs very well, providing accurate dose estimates. Average deviation from nominal doses was about 30 mGy, relative deviation - less than 14%.

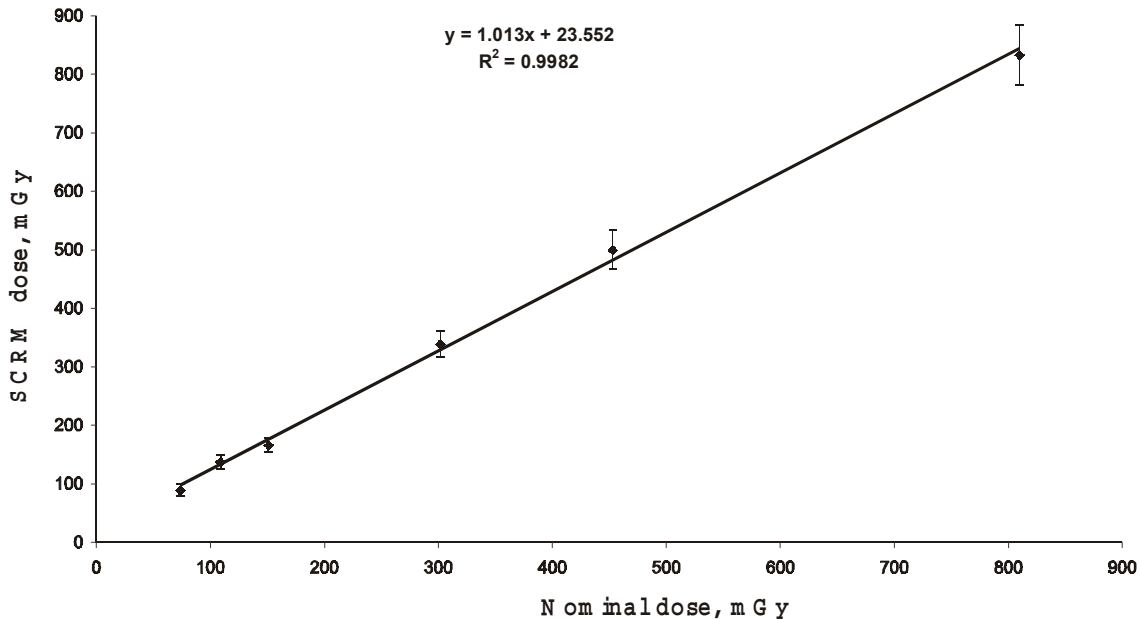

Fig.7. SCRM results in the most recent international intercalibration of EPR dosimetry with teeth (bilateral intercomparison with CAD).



Fig.8. Geography of tooth acquisition in Poltava oblast of Ukraine.

2. Application of EPR dosimetry in Ukraine

2.1 Acquisition of teeth in the national scale

As mentioned in Section 1.1 of this paper, the nationwide tooth acquisition network was established in Ukraine. In 1997 a joint order of the Ministry of Health and Academy of Medical Sciences came to effect, establishing the legal basis for collection of teeth from Chernobyl clean-up workers, which reside in 5 oblasts of Ukraine. In 2001 two more oblasts were incorporated into this network. The central bioprobe bank was established in SCRM AMS Ukraine with the function of accumulation and long term storage of the collected samples. The modern structure of the tooth acquisition network is shown at Fig.2. This network has hubs in each of the concerned oblasts, as a rule a principal dentist (officer of the Ministry of Health) is assigned to be a person responsible for operation of the regional branch of the network. As a rule, each regional hub receives collected teeth from a number of dental clinics spread over the oblast. Collection of teeth from liquidators is organized in the specialized hospitals or dental clinics, which provide medical service to Chernobyl clean-up workers. As an example, the geographical structure of tooth acquisition in Poltava oblast is presented in Fig.8.

Most general characteristics of the tooth acquisition network as well as the results of its operation are presented in Table 2. It may be seen from this table that the effectiveness of this work in different oblasts is not uniform. The best results were achieved in Kiev oblast, in which the pilot stage of this effort had begun in 1992, and in Poltava oblast. The last case is worth separate discussion. In 2000 in the framework

Table 2. Characteristics of infrastructure for collection of teeth from liquidators.

Oblast of Ukraine	Year of initiation	Number of dental clinics involved in collection of teeth	Number of dentists	Number of teeth collected in 1998-2001
Dnipropetrovsk	1998	30	40	152
Zaporizhzhya	1998	12	18	75
Kyiv	1992	5	11	2096
Poltava	1998	57	94	1360
Kharkiv	1998	5	12	247
Cherkassy	2001	5	8	27
Chernihiv	2001	2	5	24
	TOTAL:	116	188	3981

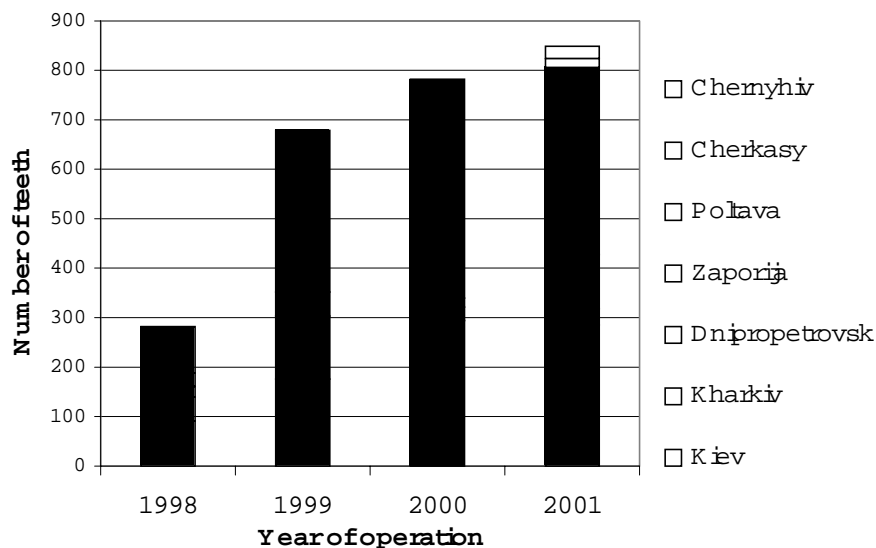

Fig.9. Collection of teeth in 7 oblasts of Ukraine.

of German-French Initiative "Chernobyl", one of the oblasts was selected for establishing "good practice" called to demonstrate the effectiveness of the tooth collection system under condition of appropriate supply. In this oblast (Poltava) the monetary incentive was provided at a sufficient level, suggesting fixed fee to the coordinator and "per sample" payment to dental practitioners and their assistants. This approach proved to be extremely efficient leading to significant expansion of the collection network (see Table 2 and Fig.8) as well to the increase of the number of collected samples (Fig.9). So the number of participating dentists increased from 11 in 1998 to 94 in 2001, annual influx of collected teeth grew more than twofold. In 2001 the logistics tested in Poltava oblast was applied in other regions covered by the tooth acquisition network.

Tooth collection is performed in the following manner. When the tooth is extracted by a dentist, the special form (see Section 1.1 for details) is filled out and the tooth is washed and placed into a paper envelope stapled to the form. Samples collected in local hospitals are forwarded to the regional hub and batches of teeth are periodically sent to Kiev to the central bioprobe bank. Upon arrival to Kiev, all samples are subjected to input control called to evaluate the state of a tooth and assign respective rank (see Table.1). Then all teeth are logged into the bioprobe bank and the information from the tooth ID form is entered into the database. Periodically (at least once per quarter) a detailed review of the quality of collected samples is prepared and sent to the oblast coordinator, providing thus a feedback to the regional level of the tooth acquisition network. Totally over the period of operation of the acquisition network (1992-2001) 3981 teeth were collected (see Table 2), and this number is increasing daily. In general, the pool of collected samples establishes a good basis for both routine dose reconstruction and, more important, for randomized selection of subjects for all kinds of validation tests (see Section 2.3 of this paper).

2.2. Reconstruction of individual doses

First time EPR dosimetry was used for reconstruction of individual doses Ukrainian liquidators in 1993. Since 1995, when the methodological guidelines [43] were adopted by the Ministry of Health, EPR dosimetry is being performed regularly. Till the end of 2001 465 individual doses were reconstructed, mostly using the whole scale SCRM protocol including individual calibration by the additive dose technique. However, all this time, our methodological research continues, finding its reflection in upgrades of the dose evaluation protocol. So, till 1999 doses were reconstructed using the whole teeth and

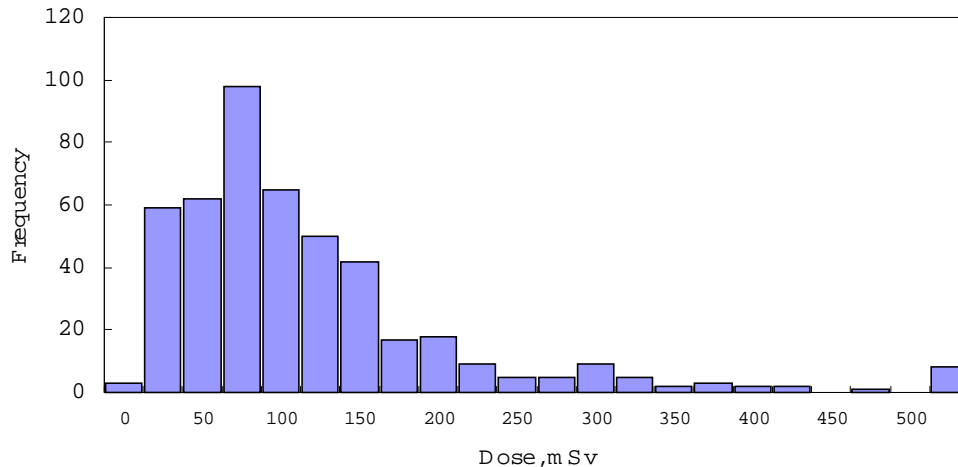

Fig.10. Distribution of individual doses of liquidators 1986-1987 assessed by EPR dosimetry with teeth.

the contribution of x-ray doses was assessed basing on the data from the tooth ID forms regarding the number of x-ray procedures and the empirical data on average doses per one examination. However, in the course of tests and comparisons we found that information from the ID forms is very unreliable and, therefore, the formerly used method of x-ray dose account is endowed with unacceptably high uncertainty. As a result, since mid 1999 we have switched to the more elaborate protocol comprising separate dose evaluation using lingual and buccal parts of teeth. All contemporary EPR analyses are performed using this approach, which allows to detect and quantify the possible contribution of dental x-ray exposure. Appearance of another confounding factor - UV exposure, which was first reported in 1996 [44], prompted the revision of all previously obtained results and withdrawal of dose estimates obtained with front teeth. Although a comprehensive study [18] of the effect of UV exposure suggested a clue to mitigation and evaluation of this effect, currently we do not use front teeth for EPR dosimetry.

Fig.10 presents the frequency distribution of individual doses of Chernobyl clean-up workers assessed by EPR. One may see that this distribution confirms the point that very high doses of liquidators were rather exception than a rule, and a mean dose of liquidators of 1986-1987 is 110 mSv.

It should be stressed that a wide scale application of high precision measurement protocol with individual calibration of each sample is a unique experience. In other cases a full scale EPR protocol was used for reconstruction up to several dozens of persons [4, 45], and a wide scale EPR dosimetry [46] was applied using certainly less accurate technique based on the use of a single calibration coefficient. In fact, application of the elaborate protocol for reconstruction of several hundreds of individual doses in Ukraine allowed not only to conduct accurate dosimetry, but also to bring some qualitatively new results. So, the effect of non-linearity of dose response curves was discovered; as discussed above, this phenomenon may have significant effect on the accuracy of dose reconstruction using EPR dosimetry with teeth. In addition, application of the additive dose technique to all studied teeth allowed comparison of radiosensitivity of different types of teeth. It was shown (Fig.11) that radiosensitivity does not depend on type and location of a tooth. Another important result is presented in Fig.12 reflecting degree of inter-sample variation of individual radiosensitivity. It was shown that relative variation of calibration coefficient (1σ) is about 12%. Remarkably, these results provide quantitative measure of additional uncertainty, which is introduced into EPR dosimetry if a method of universal calibration coefficient is used for dose assessment. This estimate (12% additional error) is applicable for all types of teeth used for dose reconstruction (Fig.11).

The results of routine EPR dosimetry are used in Ukraine in the framework of several medical

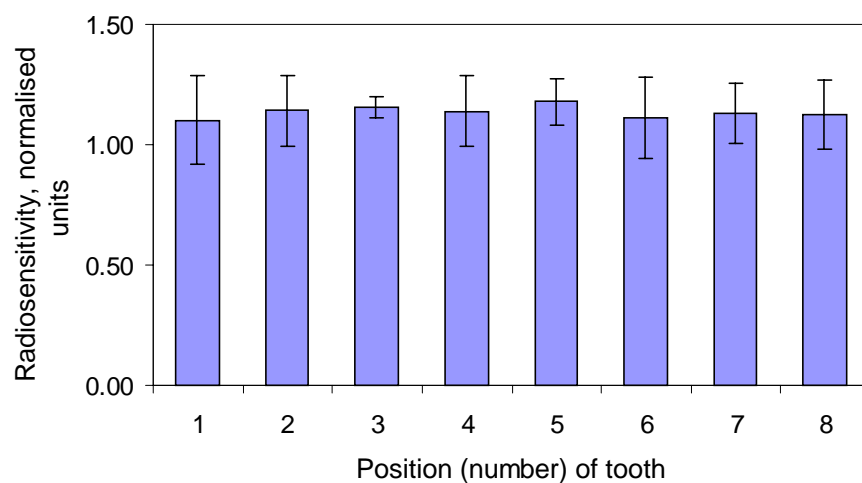

Fig.11. Radiosensitivity of different types of teeth.
Teeth nos.1-2 - incisors, 3 -canines, 4-5 premolars, 6-7 - molars, 8 - wisdom teeth.

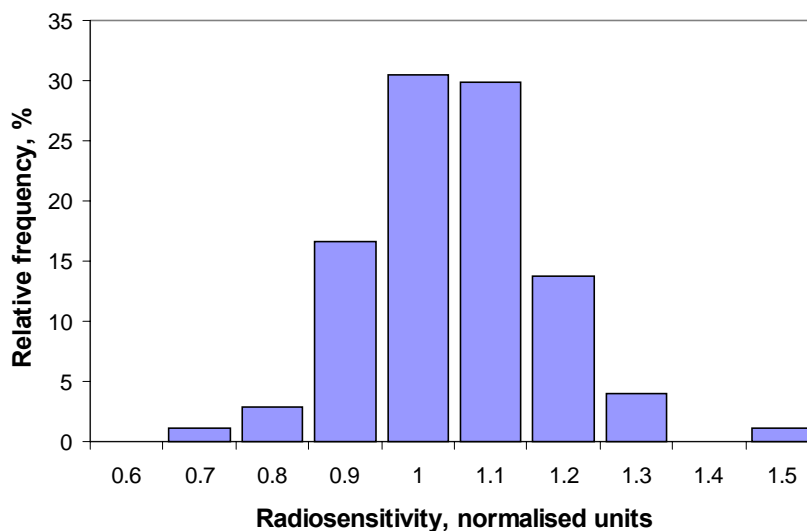

Fig.12. Distribution of individual radiosensitivity of human teeth (Ukrainian population)

studies as high precision assessments of individual doses received by liquidators. However, high cost and labor intensity of EPR dosimetry, as well as limited availability of samples, prevent this technique from being a routine dose assessment method for dosimetric support of a large-scale biomedical follow-up.

2.3. EPR dosimetry as a reference method for validation of other dose estimates

This unique application of EPR dosimetry was proposed and is effectively used in Ukraine. The matter is that prior to its application, any method of retrospective dosimetry needs to be validated by means of independent, presumably superior accuracy, "gold standard" method. From the discussion above, one may conclude that EPR dosimetry possesses unique qualities (high precision, possibility of dose reconstruction long time after exposure), which makes it an inevitable tool for calibration and validation of other methods of dosimetry. In terms of accuracy, internal consistency and overall quality, EPR dosimetry with teeth may be considered as a source of dose estimates of a reference quality. In fact, EPR dosimetry is the only retrospective dosimetry protocol, which comprises perfectly traceable elements; uncertainty of

each of them may be evaluated in rather straightforward manner. Overall performance of EPR dosimetry with teeth had been proven in the course of several blind intercomparisons (see discussion above - Section 1.3).

Therefore, on the basis of the described above results, a concept of utility of EPR dosimetry as a reference method for validation of the potent methods of retrospective dosimetry, was developed. According to this approach, the method under consideration is applied to the representative sample of subjects who have high quality (in particular, no x-ray dose) EPR dose estimates. Upon comparison of results provided by the method of concern with the "gold standard" EPR doses, the conclusion regarding the accuracy and general applicability of the given method can be derived. Not touching statistical aspects of the validation studies, here we should concentrate on the aspects related to application of EPR dosimetry.

Obviously, application of EPR as a reference method sets certain requirements for selection of subjects and quality of tooth samples. It should be stressed that selection of subjects for the validation test is one of the most demanding and responsible elements of such application. In general, subjects of the validation test should meet the following criteria:

- A tooth must be good for EPR dosimetry, i.e. it should be molar or premolar, have sufficient amount of enamel.
- Enamel must be distributed among buccal and lingual parts of a tooth, allowing thus separate analysis of these parts and evaluation of x-ray exposure.
- Indication on absence of medical x-ray examinations (e.g. from the tooth ID form).
- Availability of auxiliary dosimetric information, e.g. official dose record.
- Affiliation of a subject to the studied group (category).
- Adherence of a subject to given dose interval.
- Residence of a subject in a respective territory (for instance, the area included into certain study).
- Availability of actual postal address.
- Availability of a telephone number.
- Agreement to participate in a study (test).
- Possibility to establish personal contact with the subject (home visit or invitation for examination).

One may see that some of the requirements are difficult to meet and, moreover, sometimes they are contradictory. Certainly, depending of particular plan of the validation test, the rigidity of the above-listed criteria may vary to some extent. In general, however, the enlistment of subjects into the study group is a difficult task. There is very limited flexibility at the level of EPR dosimetry. Effectively this means that application of all criteria leads to reduction of the number of appropriate subjects. The only way to deal with depletion of the original sample is to prepare an abundant number of candidates in order to keep a desired sample size even after washing out some subjects. Since collection of teeth is very slow and inertial process, the solution lays in collection of all available teeth, their storage and selection of subjects following the criteria set by a particular study. This approach (large-scale acquisition of teeth and their retrieval from the central bioprobe bank) was implemented in Ukraine. Success of several validation studies, which involved EPR dosimetry as a reference method, unequivocally proved adequacy of this approach.

As an example of this application of EPR dosimetry, we will take the testing of classical ADR (Analytical Dose Reconstruction). This method (ADR) makes use of the information about the motions and durations during the work of liquidators at Chernobyl NPP site as well as dose rate data for assessment of their radiation doses. . The plan of the test, which was performed in 1998 in the framework of the pilot phase of Ukraine-US leukemia study, included independent evaluation of doses to 20 liquidators by ADR [47] and EPR. The following selection criteria were applied:

1. Availability of a tooth good for EPR dosimetry (no requirement regarding separate analysis of buccal and lingual parts was set at that time).
2. No more than one dental x-ray examination according the tooth ID form data.
3. Affiliation of liquidators to one of the categories for which ADR was applicable (Chernobyl NPP staff).

Totally 30 candidates were selected for this study, 20 of them were interviewed according to ADR procedure and enlisted into the study. ADR was performed by the expert-dosimetrists which routinely perform this work. Comparison of two independent dose estimates revealed quite a significant discrepancy, ADR results had a tendency to overestimation of doses. In depth analysis of ADR analysis, in particular separate consideration of isolated components of dose (note that EPR is able to assess a total dose of lifetime occupational and accidental exposure) allowed to identify the source of discrepancy. Fig.13 presents the comparison of EPR dose and a total dose assessed using ADR. For the latter, breakdown to separate components is given. Finally, it was determined that inadequately high dose estimates were assigned to the episodes of transportation across heavily contaminated territories around the NPP site. In addition, contrary to the ADR protocol, practitioners did not apply respective correction factor to the final result, i.e. the products of wrongly applied ADR were almost two times higher than the results of a canonic ADR procedure. These observations allowed us to fix the weak points of ADR and resulted in development of a substantially revised version of this analytical technique (RADRUE). From the point of view of EPR application, abbreviated account of lifetime x-ray exposure was justified by high levels of exposure of this group of liquidators and, respectively, lower contribution of x-ray exposure to a total dose.

Besides to the discussed test, this approach had been successfully implemented for testing various methods of retrospective dosimetry. Among the tested methods were FISH, SEAD (Soft Expert Assessment Dosimetry - a novel method, which makes use of typical dose distributions of particular groups of liquidators) [48] and, finally RADRUE (ADR derivative, aimed to provide most universal dose estimates to the subjects of the post-Chernobyl epidemiological study).

In general, results of such application of EPR proved to be very informative. For example, based on these validation exercises, SEAD was rejected, classical ADR revealed its weak points and suggested ways of its revision and improvement. Finally, the mentioned above RADRUE method was approved for

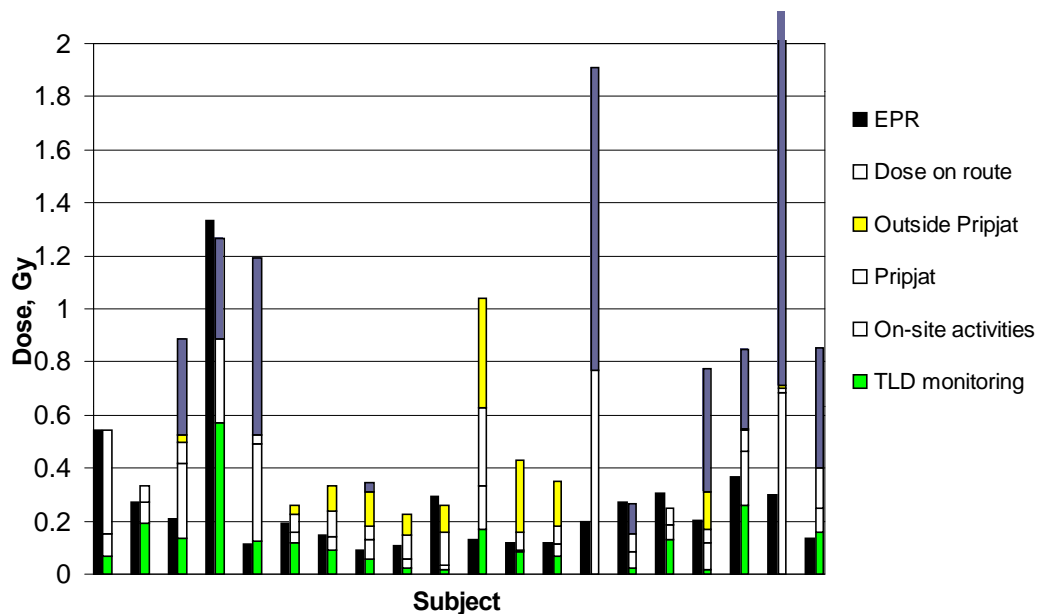

Fig.13. Results of ADR test. EPR doses vs. cumulative dose assessments with breakdown to components.

use in the framework of Ukraine-USA case-control leukemia study on the basis of the results of verification by EPR.

Conclusions

EPR dosimetry with teeth in Ukraine over the last decade went all way from first laboratory tests to a large scale routine application. A large cycle of methodological research was conducted in order to develop an original version of the EPR dosimetric protocol as well as investigate the effects caused by confounding factors and develop approaches to their account and mitigation. In the development of the EPR dosimetric protocol, the main attention was concentrated on achievement of high accuracy and reproducibility, low sensitivity threshold as well as high throughput. Elaborate quality assurance program, including a series of international intercomparisons had demonstrated high precision and sensitivity of the SCRM version of the EPR protocol. Creation and continuous operation of the nationwide tooth acquisition network is another key to the success of EPR dosimetry in Ukraine.

The main applications of EPR dosimetry in Ukraine are both routine high precision reconstruction of doses to Chernobyl clean-up workers and the use of EPR dose estimates as a reference dose for validation of other retrospective dosimetry techniques. The latter proved to be the most efficient application of EPR dosimetry in the post-Chernobyl situation. EPR dosimetry was used for testing such methods of retrospective dosimetry as FISH, ARD, SEAD and RADRUE. In general, EPR dosimetry plays inevitable role in dosimetric support of post-Chernobyl medical follow-up studies.

Reference

1. Pass B., Wood R.E., Liu F.F. et al. High radiation doses from radiotherapy measured by electron spin resonance in dental enamel. *Radiat. Prot. Dosim.* 76, 237-247 (1998).
2. Romanyukha A.A., Regulla D., Vasilenko E.K. et al. Verification of occupational doses at the first nuclear power plant in the Former Soviet Union. *Appl. Radiat. Isot.* 47, 1277-1280 (1996).
3. Nakajima T. Estimation of absorbed dose to evacuees at Pripjat-city using ESR measurements of sugar and exposure rate calculations. *Appl. Radiat. Isot.* 45(1), 113-120 (1994).
4. Romanyukha A.A., Degteva M. O., Kozheurov V. P. et al. Pilot study of the Urals population by tooth electron paramagnetic resonance dosimetry. *Radiat. Environ. Biophys.* 35, 305-310 (1996).
5. Schauer D.A., Desrosiers M.F., Kuppusamy P. et al. Radiation dosimetry of an accidental overexposure using EPR spectrometry and imaging of human bone. *Appl. Radiat. Isot.* 47, 1345-1350 (1996).
6. Regulla D.F., Deffner U. Dose estimation by ESR spectroscopy at a fatal radiation accident. *Appl. Radiat. Isot.* 40, 1039-1043 (1989).
7. Lloyd D.C., Edwards A.A., Fitzsimons E.J. et al. Death of a classified worker probably caused by overexposure to radiation. *Occup. Environ. Med.* 51, 713-718 (1994).
8. Haskell E.H., Hayes R.B., Kenner G.H. et al. Electron paramagnetic resonance techniques and space biodosimetry. *Radiat. Res.* 148, S51-S59 (1997).
9. Desrosiers M.F., Romanyukha A.A. Technical aspects of the electron paramagnetic resonance method for tooth enamel dosimetry. *Biomarkers: Medical and Workplace Applications*. Mendelsohn M.L., Mohr L.C., Peters J.P., Eds. - Washington, DC, Joseph Henry Press, 53-64 (1998).
10. Pass B. Collective radiation biodosimetry for dose reconstruction of acute accidental exposures: a review. *Environmental Health Perspect.* 105 (6), 1397-1402 (1997).
11. Romanyukha A.A., Regulla D. Aspects of Retrospective dosimetry. *Appl. Radiat. Isot.* 47, 1293-1297 (1996).
12. Ikeya M. New application of electron spin resonance. World Scientific, Singapore (1993).
13. Chumak V., Sholom S., Pasalskaya L. Application of high precision EPR dosimetry with teeth for reconstruction of doses to Chernobyl populations. *Radiat. Prot. Dosim.* 84 (1-4), 515-520 (1999).
14. Wieser A., Onori S., Fattibene P. et al. Comparison of sample preparation and signal evaluation methods for EPR analysis of tooth enamel. *Appl. Radiat. Isot.* 52 (5), 1059-1064 (2000).
15. Haskell E., Kenner G., Hayes R. et al. EPR dosimetry of teeth in past and future accidents: a prospective look at a retrospective method. *Proceedings of the second Hiroshima Int. Symposium "Effects of low-level radiation for*

- residents near Semipalatinsk nuclear test site". - Hiroshima 261-273 (1996).
16. Sholom S.V., Haskell E.H., Hayes R.B. et al. EPR-dosimetry with carious teeth. *Radiat. Meas.* 32, 799-803 (2000).
 17. Sholom S.V., Haskell E.H., Hayes R.B. et al. Influence of crushing and additive irradiation procedures on EPR dosimetry of tooth enamel. *Radiat. Meas.* 29 (1), 105-111 (1998).
 18. Sholom S. V., Haskell E. H., Hayes R. B. et al. Properties of light induced EPR signals in enamel and their possible interference with gamma-induced signals. *Radiat. Meas.* 29 (1), 113-118 (1998).
 19. Sholom S. V., Chumak V. V., Pasalskaja L.F. Some aspects of EPR dosimetry of liquidators. *Appl. Radiat. Isot.* 52, 1283-1286 (2000).
 20. Chumak V., Bailiff I., Baran N. et al. The first international intercomparison of EPR-dosimetry with teeth: first results. *Appl. Radiat. Isot.* 47 (11-12), 1281-1292 (1996).
 21. Wieser A., Mehta K., Amira S. et al. The second international intercomparison on EPR tooth dosimetry. *Radiat. Meas.* 32, 549-557 (2000).
 22. Ishii H., Ikeya M., Okano M. ESR dosimetry of teeth of residents close to Chernobyl reactor accident. *J. Nucl. Sci. and Technology.* 27 (12), 1153-1155 (1990).
 23. Onori, S., Pantaloni, M., Baccaro, S. And Fuochi, P.G. Influencing factors on ESR bone dosimetry. *Appl. Radiat. Isot.* 47, 1637-1640 (1996).
 24. Skvortsov V.G., Ivannikov A.I., Eichhoff U. Assessment of individual accumulated irradiation doses using EPR spectroscopy of tooth enamel. *J. Mol. Struct.* 347, 321-330 (1995).
 25. Brilliant M., Clevezal G, Mordvintsev P. et al. Determination of accumulated dose of gamma- exposure by tooth enamel. *Hematology and Transfusiology* 12, 11-16 (1990) (in Russian).
 26. Scherbina O.I., Brik A.B. Temperature stability of carbonate groups in tooth enamel. *Appl. Radiat. Isot.* 52, 1071-1075 (2000).
 27. Desrosiers M.F., Simic M.G., Eichmiller F.G. et al. Mechanically-induced Generation of radicals in tooth enamel. *Appl. Radiat. Isot.* 40 (10-12), 1195-1197 (1989).
 28. Onori S., Aragno D., Fattibene P. et al. ISS protocol for EPR tooth dosimetry. *Radiat. Meas.* 32, 787-792 (2000).
 29. Haskell E.H., Hayes R. B., Kenner G. H. Improved accuracy of EPR dosimetry using a constant rotation goniometer. *Radiat. Meas.* 27, 325-329 (1997).
 30. Chumak, V., Likharev I., Sholom S., Meckbach Rr., Krjuchkov V. Chernobyl experience in field of retrospective dosimetry: reconstruction of doses to the population and liquidators involved in the accident, *Radiat. Prot. Dos.* 77, 91-95 (1998).
 31. 53. Haskell, E.H., Hayes, R.B., Kenner, G.H., Wieser, A., Aragno, D., Fattibene, P., Onori, S. Achievable precision and accuracy in EPR dosimetry of tooth enamel. *Radiat. Prot. Dosim.* 84. 527-535 (1999).
 32. 55. Gualtieri, G., Colacicchi, S., Sgattoni, R., Giannoni, M. The Chernobyl accident: EPR dosimetry on dental enamel of children. *Appl. Radiat. Isot.*, 55, 71-79 (2001).
 33. 103. Shimano T., Iwasaki M., Miyazawa C., Miki T., Kai A., Ikeya M. Human tooth dosimetry for gamma-rays and dental x-rays using ESR. *Appl. Radiat. Isot.* 40, 1035-1038 (1989).
 34. Aitken M. J. Thermoluminescence dating. Academic Press, London (1985).
 35. Hayes R.B., Haskell E.H., Kenner G.H. et al. A virtually nondestructive EPR technique accounting for diagnostic X-rays. *Radiat. Meas.* 32, 559-566 (2000).
 36. Radiological consequence of the Chernobyl accident. Kryshev I., Ed. Nuclear Society International, Moscow (1992).
 37. Chumak V., Pavlenko Ju., Sholom S. An approach to the assessment of overall uncertainty of determination of dose using an ESR technique. *Appl. Radiat. Isot.*, 47 (11/12), 1287-1291 (1996).
 38. Rose K., Smith E., Gardner R. et al. Parameter sensitivities, Monte Carlo filtering and model forecasting under uncertainty. *J. of Forecasting*, 10, 117-133 (1991).
 39. Sholom, S.V., Chumak, V. Methodological aspects of EPR dosimetry with teeth. *Proc. Of the meeting of Austrian radiation protection society: Radiation protection for people and society in tomorrows Europe*, Sept.17-21, Gmunden, 2001., P.78-82 (2001).
 40. Sholom, S.V., Chumak, V., Pavlenko, J. The doses from diagnostic x-ray procedures in the EPR spectroscopy technique with tooth enamel. *Proc. of the IPRA Regional Symp. On Radiation Protection in Neighboring Countries of Central Europe*, Sept.8-12, Prague, 571-574 (1997).

41. Haskell E., Kenner G., Hayes R. et al. An EPR intercomparison using teeth irradiated prior to crushing. *Radiat. Meas.*, 27 (2), 419-424 (1997).
42. Chumak, V., Likhtarev, I., Sholom, S., Pasalskaya, L. Pavlenko, Y. Retrospective reconstruction of radiation doses of Chernobyl liquidators by electron paramagnetic resonance. Armed Forces Radiobiology Research Institute, Bethesda, MD, USA (1997).
43. Assessment of external exposure dose for individuals exposed due to Chernobyl and other radiation accidents with EPR spectroscopy of tooth enamel. Temporary guidelines. Ministry of Health of Ukraine, Kiev (1995).
44. Liidja G., Past J., Puskar J. et al. Paramagnetic resonance in tooth enamel created by ultraviolet light. *Appl. Radiat. Isot.* 47 (8), 785-788 (1996).
45. Nakamura N., Miyazawa C., Sawada S. et al. A close correlation between electron spin resonance (ESR) dosimetry from tooth enamel and cytogenetic dosimetry from lymphocytes of Hiroshima atomic-bomb survivors. *Int. J. Radiat. Biol.*, 73 (6), 619-627 (1998).
46. Ivannikov A.I., Skvortzov V. G., Stepanenko V. F. et al. Wide-scale EPR retrospective dosimetry: results and problems. *Radiat. Prot. Dosim.*, 71 (3), 175-180 (1997).
47. Nossovsky A., Ed. Retrospective dosimetry of participants of clean-up after Chornobyl accident (1996) Seda-stil, Kiev (in Russian).
48. Krjuchkov V.P., Chumak V.V., Kosterev V.V. The Problem of Dose Reconstruction for Liquidators of ChNPP Accident and the Possibility of it's Decision by Fuzzy Sets Method. Proc. 1998 ANS Radiation Protection and Shielding Division Topical Conf. "Technologies for the New Century". Vol.1., Nashville (USA), 562-567 (1998).

Retrospective Dose Assessment of Inhabitants in the Contaminated Areas of Russia by EPR Measurement of Tooth Enamel

Alexandre I. IVANNIKOV, Valeri G. SKVORTSOV, Valeri F. STEPANENKO

*Medical Radiological Research Center of RAMS,
Korolyov str. 4, 249020 Obninsk, Russia: a_ivann@mail.ru*

Abstract

Results of wide-scale dose reconstruction with the use of EPR spectroscopy of tooth enamel are presented for the population living in the radioactive contaminated territories of Bryansk region of Russia. The population of radiation-free territories of neighboring Kaluga region was examined as the control group. The excess doses caused by radiation contamination were determined after subtraction of the contribution into EPR signal in tooth enamel due to the action of the natural background radiation during the lifetime of teeth. The average excess doses were determined for the groups of population formed according to the place of residence. The average values were determined with accuracy ranging from 4 to 25 mGy depending on the number of individuals included into the groups and on the scattering of individual results. The average excess doses highly varied for different places of residence and ranged up to 70 mGy. In general, the average doses of external exposure of the population obtained with EPR spectroscopy of teeth enamel were found to be consistent with the results based on other methods of direct dosimetry and retrospective dose reconstruction methods. Essential exceeding of the individual doses above the average level within the population groups was observed for some persons. That gave a possibility to detect the individuals with overexposure and to include them into groups of increased radiation risk for medical monitoring.

Introduction

It is known that tooth enamel exhibits the features of individual dosimeter and it may be used for assessment of individual accumulated doses in accidental and uncontrolled situations. The stable paramagnetic centers are formed in calcified matrix of tooth enamel after its exposing to ionizing radiation. These centers can be detected using the spectroscopy of electron paramagnetic resonance (EPR), and the individual accumulated doses can be estimated.

The method of EPR dosimetry was successfully applied for dose reconstruction at uncontrolled irradiation [1-5].

This method of EPR dosimetry has advantages that tooth enamel accumulates the results of radiation influence during a whole period of existence of tooth enamel after its formation. Hence, EPR dosimetry with tooth enamel is suitable for dose reconstruction many years after the exposure. This technique is of particular interest in case when the results of conventional dosimetry are not available (e.g. in accidental circumstances), especially many years after the event, and when doses were accumulated during long period of irradiation. Just the case is dose reconstruction for inhabitants in the contaminated areas after the Chernobyl accident. A disadvantage of the method is that there are problems at sample collection, because it is usually possible to obtain only teeth extracted for health reasons. So, it is often difficult to collect enough samples from the population group of concern.

In this work, the results of EPR dosimetry for the population living in the south-west territories of Bryansk region subjected to radioactive contamination after the Chernobyl accident are summarized and analyzed basing on our previous publications [4-7]. As a control groups, the population of

uncontaminated territories of the north part of Kaluga region was investigated.

All measurements were carried out with the same methodical approach adopted as standardized in routine measurements, rigorously the same for all enamel samples. That permitted to make a combined comparative statistical analysis at the examination of all obtained results which were considered to have the same systematic uncertainties.

Materials and methods

Tooth samples were collected in local dental clinics as extracted during an ordinary dental practice. Information about patients and teeth were provided by dentists in special questionnaires together with the samples.

The optimized methodical approach developed in MRRC and adopted as standard for all routine measurements was used for investigation of all enamel samples. Detailed description and basing of the methodical approach are given in the previous publications [4,8], which meets the requirements of State Standard of Russian Federation (1995) [9]. The essential features of the methodical approach used for dose reconstruction are the following.

Enamel samples were prepared by removing dentine from a crown of tooth using hard alloy dental drills at low rotation speed and were cut to pieces of about 1.0 mm. Samples with mass in the range 60 - 120 mg were assumed to be suitable for measurements. The EPR spectra were recorded at room temperature with ESP-300-E spectrometer (Bruker, Germany) using a standard rectangular probe cavity in X-band at microwave power of 10 mW. Modulation amplitude is 0.3 mT, sweep width 8 mT. The time of recording of each spectrum with 16-time accumulation was 45 min. The amplitude of the 4-d line of marker sample containing MnO permanently mounted near the bottom of the cavity was used as a signal intensity reference.

It is known that an EPR spectrum of irradiated dental enamel is composed of two overlapped principal signals: the radiation induced signal (RIS) and the radiation-independent native background signal (BGS) described elsewhere [1,10]. In order to separate the RIS and determine its intensity, the basic software of the build-in computer was used for spectra processing. The spectrum of children's unirradiated enamel was used as the reference spectrum to simulate BGS. The amplitude, field position and width of the reference BGS were manually adjusted under operator control to fit the low-field part of the measured spectra, where RIS was not revealed. The pure RIS was obtained after subtraction of the simulated BGS. The intensity of RIS was measured as the amplitude of its low-field maximum.

The intensity of RIS was converted into units equivalent to exposure dose at calibration according to the following formula:

$$R = A K_{cal} , \quad (1)$$

where:

$A (g^{-1})$ - intensity of the RIS normalized by sample mass and by intensity of the marker signal;

$K_{cal} (mGy g)$ - calibration coefficient corresponding to average slope of enamel EPR response to radiation versus exposure dose. This coefficient was taken as reciprocal of an average slope of calibration dependencies measured for several enamel samples exposed to a direct collimated beam of ^{60}Co gamma-radiation source in dose range 0 - 500 mGy. The exposure dose was measured as air kerma by an air equivalent dosimeter. Calibration with ^{137}Cs source gives approximately the same estimation for radiation sensitivity of enamel [11].

The intensity of RIS expressed in units equivalent to exposure dose at calibration was converted to dose absorbed in enamel according to the formulae:

$$D_{en} = (R - D_i) K_{air-en} , \quad (2)$$

where:

$K_{air-en} = 0.99$, conversion coefficient of air equivalent exposure dose at calibration to units of dose absorbed in enamel. In the region of relatively high photon's energy, which were used at calibration, it is determined by the ratio of mass-energy absorption factors of the enamel to that of the air, and its value is close to unity [12].

D_i - measurement bias arising from intercept value of the calibration dependence of the RIS intensity versus irradiation dose. It is sometimes called initial (or intrinsic) signal [13,14]. This value is specific for measurement conditions and spectra processing procedure. The value of this parameter is mainly determined by difference of the BGS lineshape between the spectra of samples under investigation and the reference spectra used for simulation of the BGS. Its average value can be determined from calibration dependencies after correction on the contribution of natural background radiation. In the case of methodical approach used for spectra processing in this study, its average value was adopted as 65 mGy with a standard deviation of individual values estimated as about 20 - 30 mGy [4].

The additional dose (or excess dose) values caused by additional irradiation due to radiation contamination were determined by subtracting the contribution from natural background radiation accumulated during the lifetime of the tooth (age of the tooth from its formation up to the measurement for dose reconstruction):

$$D_{add} = D_{en} / K_{en} - TA \cdot D_n , \quad (3)$$

where:

$K_{en} = 1.2$ - correction factor on the energy dependence of enamel sensitivity taken for radiation of ^{137}Cs contaminated soil [13].

$D_n = 0.8 \text{ mGy y}^{-1}$ - the annual contribution to dose in enamel due to accumulation of the natural background radiation corresponding to typical value in radiation free territories of central Russia;

TA - age (lifetime) of the tooth (in years).

The lifetime of the tooth was obtained by subtraction of the average age of tooth formation for a given tooth position from the age of a person at the moment of measurement. The ages of tooth formation were determined according to published data [13,15].

The values of the calculated excess doses in some cases may be negative following subtraction of the measurement bias and the accumulated background radiation. This is a result of uncertainty in the RIS amplitude determination near the threshold of sensitivity. These negative values should not be rejected as having no physical meaning, but should be used for subsequent statistical treatment to get true average values and distribution parameters.

A semi-empirical formula for the standard error of estimation dose absorbed in enamel was used:

$$Er^2 = Er_1^2 + (Er_2 / (m/100))^2 + (Er_3 D_{en})^2 , \quad (4)$$

where:

Er - overall uncertainty of dose determination;

$Er_1 = 30 \text{ mGy}$ – constant contribution to the error due to individual variation of the enamel properties (BGS lineshape variation and impurity signals);

$Er_2 = 30 \text{ mGy}$ – parameter specifying the sample mass dependent contribution to the error due to instability and low frequency component of electronic noises of the spectrometer;

$m/100$ = sample mass (in mg) normalized by the standard value of 100 mg;

$Er_3 = 0.15$ – coefficient specifying the contribution due to individual variation of the enamel EPR dose response and to uncertainties in exposure dose determination at the calibration.

The formula was derived under the following considerations. There should be a constant contribution to the error of RIS amplitude determination due to variation of the individual sample BGS line shape. In addition, there should be a contribution due to uncertainty of the RIS amplitude determination, which is caused by a low frequency noise component of EPR spectra. This contribution is

specific for the sensitivity of the spectrometer used and for the precision of the spectra processing procedure. Since the RIS value is normalized by a sample mass to obtain a dose value, this contribution should be inversely proportional to sample mass. There also should be a dose dependent contribution due to variation of enamel sensitivity and uncertainties of dose response calibration experiments [13,16]. It should be emphasized that the values of the parameters in this formula are specific for experimental conditions. These parameters were also determined in calibration experiments for methodical approach similar to that used in this study [17,18].

The methodical approach of MRRC used in this study was tested at international intercomparison [12], and it was proved to reconstruct doses with uncertainty within 32 mGy in the dose region 0 – 800 mGy. A modification of this methodical approach with the use of specially designed automatic computer software was also tested [17,18], and the uncertainty of 25 mGy was achieved in the dose region 0 – 500 mGy.

So, the uncertainty of individual dose measurement in the range 200 - 300 mGy will be about 30 - 50 mGy for the sample mass range used. The close level of uncertainty is observed in the deviation of results around the regression line for dose-age dependence obtained for the control population in uncontaminated territories [4].

The specific feature of this method appears when it is applied to for groups of population ; the averaging of results reduces random errors. Accuracy of averaged value of the determined dose for the group of population (at $N \sim 50 - 100$ persons) may be estimated as $Er_N = Er / N^{1/2} \sim 5 \text{ mGy}$.

Results and discussion

The collection of tooth samples for EPR measurements was started in 1993. The structure of population groups and the number of analyzed samples are presented in Table 1. All measured EPR spectra in digital form, the result of measurement of RIS values together with questionnaire information on patients were entered in a computer database, and used for subsequent interpretation and statistical treatment. The tooth enamel samples are also preserved and are available for repeated duplicate measurements.

Table 1. Structure of population groups and numbers of measurements by tooth enamel EPR spectroscopy for different population groups.

Population groups	Number of measurements for each group
Radiation contaminated territories of Bryansk region	2518
Among them:	
Gordeevka district	625
Zlynka district	384
Klimovo district	423
Klyntsy district	382
Klyntsy city	280
Krasnaya Gora district	163
Novozybkov district	81
Starodub district	180
Control territories (uncontaminated territories of Kaluga region)	420
The Chernobyl liquidators	122
Total number of measurements	3060

In the course of investigations, the essential contribution into RIS due to the action of ultraviolet component of solar light was revealed in tooth enamel from front part of jaw (incisors and canines, teeth with positions 1 - 3) [4,19,20]. Therefore, it was concluded that only results obtained for back teeth (premolars and molars, positions 4 - 8) are suitable for interpretation in terms of exposure dose. Part of measurements (about one third) was performed for front teeth or for teeth with unknown position in the former period, when the effect of solar light on front teeth has not been discovered yet. Wherefore, the results for front teeth and for teeth with unknown positions were rejected and are not considered here.

The dynamics of RIS formation in tooth enamel was analyzed to examine its dependencies on the

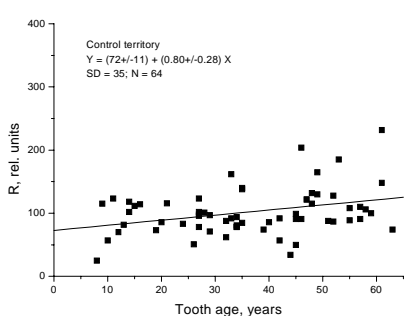

Fig. 1 a

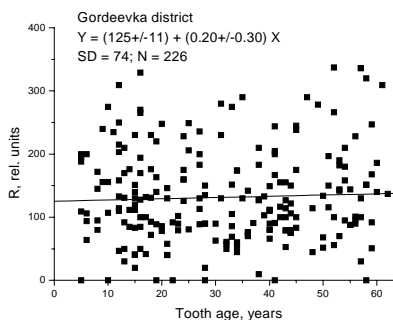

Fig. 1 b

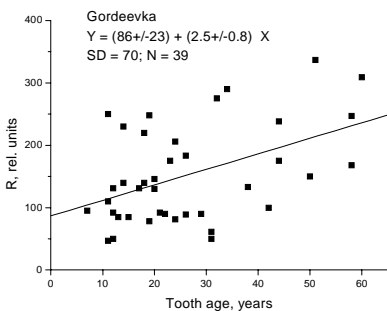

Fig. 1 c

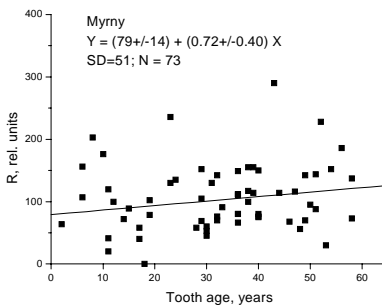

Fig. 1 d

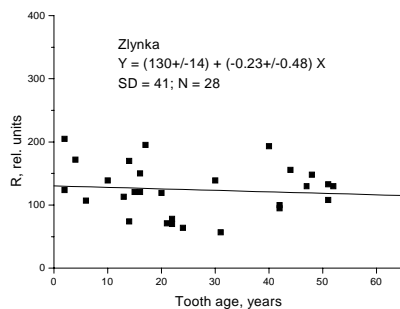

Fig. 1 e

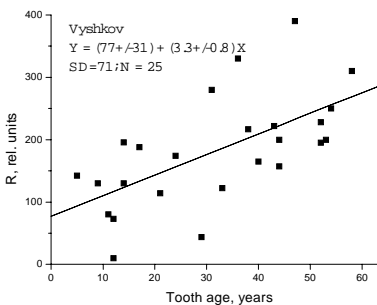

Fig. 1 f

Fig. 1. Dependencies of the RIS in enamel on tooth age for different groups of population.

(a) control territory; (b - f) radioactive contaminated territories: (b) Gordeevka district (^{137}Cs soil contamination density ranges from 1 to 41 Ci km^{-2}); (c) settl. Gordeevka, (5 to 40 Ci km^{-2}); (d) settl. Myrny (Gordeevka district), (9 to 85 Ci km^{-2}); (e) settl. Zlynka (10 to 70 Ci km^{-2}); (f) settl. Vyshkov (Zlynka district) (9 to 45 Ci km^{-2}). Parameters of the appropriate linear regressions are given on the figures (SD - standard deviation from regression line, N - number of measurements). The RIS values are expressed in relative units corresponded to exposure dose units at calibration with ^{60}Co gamma-radiation source. Note that the measurement bias is not subtracted from the RIS.

age of teeth. Such dependencies on the examples of groups of population living in different territories are presented in Fig. 1.

It should be emphasized that the RIS values in these plots should not be interpreted as absolute values of doses, because the measurement bias was not subtracted at conversion of RIS to dose units according to the formula (1). Only results for adults are considered in order to avoid complication. The results for the control territory (Fig. 1 (a)) have clear tendency to grow with the age. This is well accounted for by accumulation of the effect of natural background radiation with annual accumulated dose about 1 mGy. Such clear tendency is not observed and the data scattering is much higher in Fig. 1 (b)

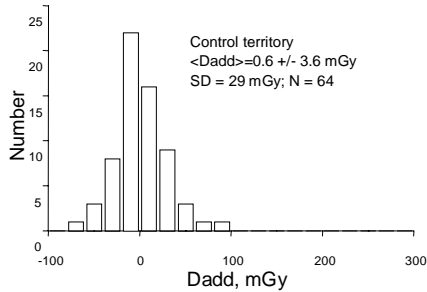

Fig. 2 a

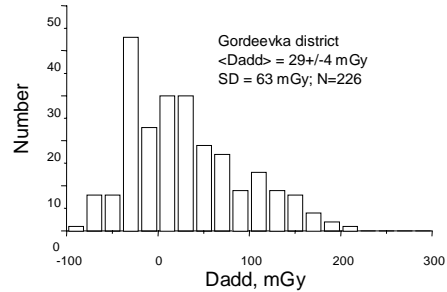

Fig. 2 b

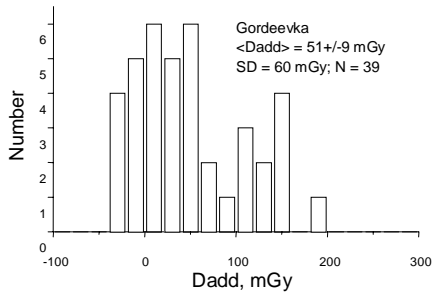

Fig. 2 c

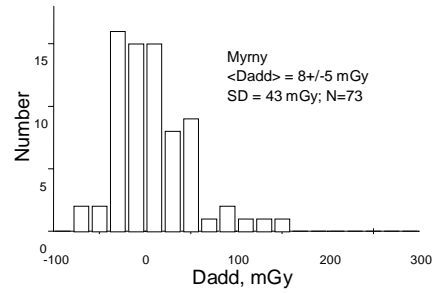

Fig. 2 d

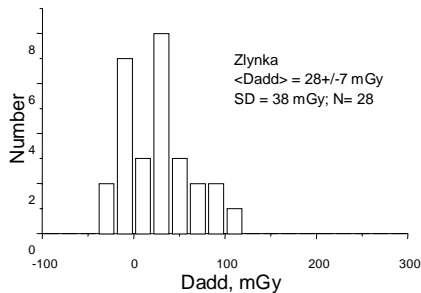

Fig. 2 e

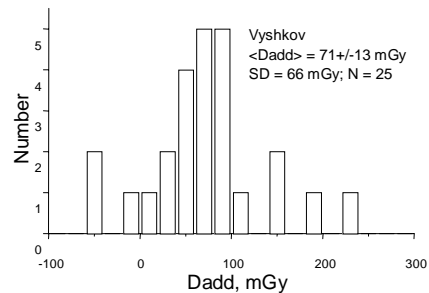

Fig. 2 f

Fig. 2. Histograms of additional dose distribution (the corrections are made with $D_i = 65$ mGy, $K_e = 1.2$; $D_n = 0.8$ mGy year $^{-1}$):

(a) control territory; (b - f) radioactive contaminated territories: (b) Gordeevka district; (c) settl. Gordeevka; (d) settl. Myrny; (e) settl. Zlynka; (f) settl. Vyshkov. Parameters of distributions are given on the pictures ($\langle D_{add} \rangle$ - average value; SD - standard deviation of the measurement; N - number of measurements).

for the population of Gordeevka district as a whole. For the population of individual settlements in Gordeevka district (Fig. 1 (c)-(f)), however, some tendencies in the course of the RIS with age can be found. Data scatterings in individual settlements are smaller in comparison with that for the whole Gordeevka district but higher in comparison with the control territory.

The observed slopes of appropriate linear regression can not be explained by accumulation of the effect of natural background radiation. In some cases it is too high and in some cases, on the contrary, it becomes negative. Such high data scattering and complicated behavior of age dependencies is obviously caused by additional contribution into exposure due to radioactive contamination of territory, which was different for individuals of different ages.

The interpretation of the obtained results is rather complicated and ambiguous. High data scattering may be caused by differences of professional occupation and high heterogeneity of radiation contamination within the bounds of settlements. It was found that results of dose rate measurements after the accident varied by factors up to 20 in different points of the same settlement (IAEA Technical Report, 1992, p.186) [21]. The differences in the slope of age dependencies may be caused by peculiarities of professional occupation and migration behaviour of population of different age groups. According to the analysis of migration of the population in radiation contaminated territories of Bryansk region [22], over 60% of population of some districts have been changed because of migration during the time period after the Chernobyl accident. It is known that in Myrny and Zlynka settlements especially high migration of the population had taken place and effective countermeasures against radioactive overexposure of population have been undertaken.

Results of RIS measurements were interpreted in terms of additional expose doses D_{add} due to

Table 2. Average additional doses determined using tooth enamel EPR spectroscopy.

	N	$\langle D_{add} \rangle$, mGy	SE , mGy	SD , mGy	$Q^{137}Cs$, $kBq\ m^{-2}$	$Q^{137}Cs$, $Ci\ km^{-2}$
Bryansk region:						
<i>Gordeevsky district</i>	226	29	4	63		
Myrny	73	8	5	43	1120	30.2
Gordeevka	34	51	9	60	760	20.7
Tvorishino	15	51	14	54	380	10.3
Kozhany	13	4	10	36	1400	37.7
Strugova Buda	10	23	25	56	296	8.0
<i>Klintsy city</i>	150	28	12	48	130	3.6
<i>Klitzovskiy district</i>	114	30	8	48		
Smotrova Buda	16	40	16	62	200	5.4
Smolevichi	16	40	16	62	100	2.7
Gulevka	11	19	16	48	260	7.0
<i>Zlynkovskiy district</i>	104	50	8			
Zlynka	28	28	7	38	1000	26.8
Vyshkov	25	71	13	66	1000	27.1
<i>Krasnogorsky district</i>	26	6	8	40		
<i>Klimovskiy district</i>	34	12	7	32		
Klimovo	11	26	15	40	270	7.4
Kaluga region (control territories):						
<i>Borovskiy district</i>	64	1	4	29	<4	<0.1

Only posterior teeth with positions 4 - 8 of adults are used. Results are corrected on initial intrinsic signal 65 mGy, energy dependence correction factor 1.2 and on the accumulated natural background radiation 0.8 mGy per year during time of tooth existence.

N - number of measurements; $\langle D_{add} \rangle$ average additional dose, SE - standard error of the average; SD - standard deviation of the measurement; Q - density of contamination of soil by ^{137}Cs according to (Reference book, 1992)

radioactive contamination according to the formulae (3). Examples of histograms of additional dose distribution for population of different territories are presented in Fig. 2. The parameters of distributions are given on figures. The standard width of distribution of the control territory (29 mGy) gives the approach to estimate the constant contribution of natural background to the overall uncertainty of dose reconstruction in low dose range, if we can assume that all persons were subjected to natural background radiation in the same conditions. It is clearly seen in Fig. 2 that the width of distributions and average values are higher for the population of contaminated territories in comparison with ones for the control territory. The contribution into these parameters is given partially by random error of individual measurements and the rest - by differences between individual excess doses. The average values show the possibility to estimate the level of radiation effect upon the population of given territory with relatively high accuracy.

The averaged values of additional doses determined from the intensities of RIS with taking into account correction parameters for different groups of population are presented in Table 2. Only those settlements where more than 10 measurements have been made are included into the table. The values for average level of radioactive contamination of settlements by ^{137}Cs were taken from Reference book (1992) [23]. It should be mentioned that average values of radioactive contamination are determined with high uncertainties because of small number of measurements in every settlement and large variation of the local contamination.

The dependence of the average dose versus the average level of contamination is presented in Fig. 3. The initial part of this dependence is well described by the weighted linear regression with the slope 0.068 ± 0.010 mGy per kBq m^{-2} (2.4 ± 0.4 mGy per Ci km^{-2}). This value is well consistent with one obtained by analytical method for accumulated external dose during 8 years in the radioactive contaminated territory. In Technical Report IAEA (1992, p246) [21] the value of the appropriate coefficient was estimated for Bryansk region as 1.6 mGy per Ci km^{-2} for the first 4 years after the accident.

As can be seen in Fig. 3, the results for Zlynka, Myrny and Kozhany settlements are not included within the calculation of regression line. Average doses in these three settlements have anomalous low values. Relatively low doses may be explained by a result of countermeasures which were undertaken in these settlements having extremely high level of contamination. It should be mentioned that the analogous effect was observed for the results of direct exposure doses measurements by individual dosimeters (ECP 10 Report 1996, pp104-110) [24], and it was explained by high value of shielding factor due to countermeasures in high contaminated territories.

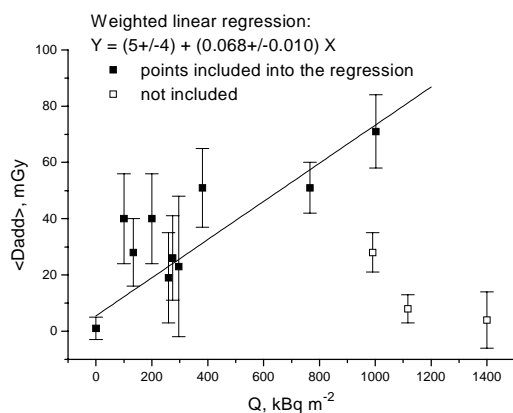

Fig. 3. The dependence of the averaged additional doses determined by tooth enamel EPR-spectroscopy on the level of ^{137}Cs contamination of settlements.

Parameters of the weighted linear regression are presented on the figure.

Conclusions

Regularities in formation of individual doses for the population residing radiation free and radiation contaminated territories as a function of teeth age and ^{137}Cs contamination density have been traced. Statistical analysis of results allowed to detect the contribution into accumulated exposure dose due to the action of the natural background radiation and due to radioactive contamination of territory.

In general, the average doses of external exposure of the population obtained with EPR spectroscopy of teeth enamel are consistent with the results based on other methods of direct and retrospective dosimetry. Relatively low average dose values obtained for some settlements may be explained by peculiarities of behaviour and migration of population. It makes possible to appreciate the efficiency of countermeasures undertaken for prevention of overexposure of population.

The significant exceeding of the individual doses above the average level within the population groups is observed for some persons. This permits to choose the individuals with high radiation risk among the population of radioactive contaminated territories and also to detect the overexposure among the Chernobyl liquidators. Received results of measurement of individual doses are used for formation of groups of increased radiation risk for subsequent medical and dosimetric control.

References

1. Ikeya, M., Miki, K., Kai, A., Hoshi, M. ESR dosimetry of A-bomb radiation using tooth enamel and granite rocks. *Radiat. Prot. Dosim.* 17: 181-184 (1986).
2. Nakamura N., Miyazawa C., Sawada S., Akiyama M. and Awa A. A. A close correlation between electron spin resonance (ESR) dosimetry from tooth enamel and cytogenic dosimetry from lymphocytes of Hiroshima atomic-bomb survivors. *Int. J. Radiat. Biol.* 73 (6): 619-627 (1998).
3. Romanyukha, A.A., Ignatiev, E.A., Vasilenko, E.K., Drozhko, E.G., Wieser, A., Jacob, P., Keirim-Markus, I.B., Klestchenko, E.D., Nakamura, N. and Miyazawa, C. EPR Dose Reconstruction for Russian Nuclear Workers. *Health Phys.* 78 : 15-20 (2000).
4. Ivannikov A. I., Skvortsov V. G., Stepanenko V. F., Tikunov D. D., Romanyukha A. A., Wieser A. Wide scale EPR retrospective dosimetry: Results and problems. *Radiation Protection Dosim.* 71(3): 175-180 (1997)
5. Skvortsov V.G., Ivannikov A.I., Stepanenko V.F., Tsyb A.F., Khamidova L.G. Kondrashov A.E., Tikunov D.D. Application of EPR retrospective dosimetry for large-scale accidental situations. *Appl. Radiat. Isot.* 52: 1275-1282 (2000)
6. Stepanenko V., Skvortsov V., Tsyb A., Ivannikov A., Kondrashov A., Tikunov D., Iaskova E., Shakhtarin V., Petin D., Parshkov E., Chernichenko I., Snykov V., Orlov M., Gavrilin Yu., Khrusch V. and Shinkarev S. Thyroid and whole-body dose reconstruction in Russia following the Chernobyl accident : review of progress and results. *Radiat. Prot. Dosim.* 77 (1/2): 101 - 106 (1998).
7. Takada J., Hoshi M., Endo S., Stepanenko V., Kondrashov A., Petin D., Skvortsov A., Ivannikov A., Tikunov D., Gtavrilin Y. and Snykov V. Dosimetry studies in Zaborie village. *Appl. Radiat. Isot.* 52 (11/12): 1165-1169 (2000).
8. Skvortsov V. G., Ivannikov A. I. and Eichhoff U. Assessment of individual accumulated irradiation doses using EPR spectroscopy of tooth enamel. *J. Molec. Struct.* 347 : 321-329 (1995).
9. State Standard of Russian Federation GOST R 22.3.04-95. Safety in emergencies. Dosimetric control of population. Method of absorbed radiation doses measurement using ESR-spectra of tooth enamel. Gosstandard , Moscow, 1995 (in Russian)
10. Pass, B. and Aldrich J.E. Dental Enamel as an Vivo Radiation Dosimeter. *Med. Phys.* 12 : 305-307 (1985).
11. IAEA Report. EPR biodosimetry. Final report of the coordinated research project on EPR dosimetry. IAEA, Vienna, 2001.
12. Wieser, A., Mehta, K., Amira, S., Argano, D., Bercea, S., Brik, A., Bugai, A., Callens, F., Chumak, V., Ciesielski, B., Debuyst, R., Diliu, O., Fattibene, P., Haskell, E., Hayes, R., Ignatiev, E., Ivannikov, A., Kirilov, V., Klestchenko, E., Nakamura, N., Nowak, J., Onori, S., Pass, B., Pivovarov, S., Romanyukha, A., Schames, A., Scherbina, O., Sholom, S., Skvortsov, V., Stepanenko, V., Tikunov, D. and Toyoda, S. The second International

- Intercomparison on EPR Tooth Dosimetry. *Radiat. Meas.* 32: 549-557 (2000).
13. Ivannikov A. I., Skvortsov V. G., Stepanenko V. F., Tsyb A. F., Khamidova L. G., Tikunov D. D. Tooth enamel EPR dosimetry: Sources of errors and their correction *Appl. Radiat. Isot.* 52: 1291-1296 (2000).
 14. Wieser A., Onori S., Argano D., Fattibene P., Romanyukha A., Ignatiev E., Koshta A., Skvortsov V., Ivannikov A., Stepanenko V., Chumak V., Sholom S., Haskell E., Hayes R. and Kenner G. Comparison of sample preparation and signal evaluation methods for EPR analyses of tooth enamel. *Appl. Radiat. Isot.* 52: 1059-1064 (2000b).
 15. Pekker R. Ja. Diseases of teeth and mouth cavity. Moscow: Medicine, 1986 (in Russian).
 16. Wieser A., El-Faramwy N., Mechbach R. Dependencies of the radiation sensitivity of human tooth enamel in EPR dosimetry. *Appl. Radiat. Isot.* 54: 793-799 (2001)
 17. Ivannikov, A.I., Skvortsov, V.G., Stepanenko, V.F., Tikunov, D.D., Takada, J., Hoshi, M. EPR Tooth Enamel Dosimetry: Optimization of the Automatic Spectra Deconvolution Procedure. *Health Phys.* 81(2): 124-137 (2001).
 18. Ivannikov A., Trompier F., Gaillard-Lecanu E., Skvortsov V., Stepanenko V. Optimisation of recording conditions for the EPR signal used in dental enamel dosimetry. *Radiat. Prot Dosim.* (2002) in press.
 19. ECP 10 Report. Experimental Collaboration Project ECP 10. Retrospective Dosimetry and Dose Reconstruction. Final Report. (Eds. Bailiff I. and Stepanenko V.) EUR 16540 EN, Brussels: 1996.
 20. Liidja G., Past J., Puskar J. and Lipmaa E. Paramagnetic resonance in tooth enamel created by ultraviolet light. *Appl. Radiat. Isot.* 47 (8): 785-788 (1996).
 21. IAEA Technical Report. International Chernobyl Project. IAEA, Vienna, 1992.
 22. Dorokhov V. V. and Romanova G. A. Migration processes in the areas of radionuclide contamination of Bryansk oblast. In: Medical effects of low radiation to children, adolescents and pregnant: Collected scientific papers (Eds. by Parshkov E. M., Knjasev Y. A. and Shakhtarin V. V.), Obninsk - Moscow, 1994, issue 2, pp. 152 - 154 (in Russian).
 23. Reference book on the radiation situation and radiation doses in 1991 for the population of the areas of Russian Federation exposed to radioactivity as a result of the Chernobyl accident Part 1. Eds. by Ballonov M. I. and Ivanov E. V.: St. - Petersburg, Ariadna, 1992 (in Russian).

Estimations of Radiation Risk for the Population of Contaminated Territory of Belarus

Vladimir A. KNATKO, Mikhail M. KOMOCHKOV* and Alla E. YANUSH

Institute of Radiobiology of the National Academy of Sciences of Belarus

Kuprevich str. 2, 220141 Minsk, Belarus: V_Knatko@radbio.bas-net.by

**Joint Institute for Nuclear Research, 141980 Dubna, Moscow Region, Russia*

Abstract

Accumulated doses for adult residents of contaminated regions of Belarus were calculated for different periods after the Chernobyl accident. The average dose during the period of 1986-2001 was evaluated to be 50 mSv and 39 mSv in the southern and the eastern contaminated regions of Belarus, respectively. Data obtained were used to evaluate the excess of the relative risk of cancer mortality for adult residents of contaminated regions in terms of Two Defence Reactions (TDR) model developed on the basis of modern results of radiobiological investigations. The results show that the excess of the relative risk (ERR) of cancer mortality as a result of the Chernobyl accident is about 5–6% during the whole life. The results were compared with risk values estimated in the framework of the 1990 Recommendation of the ICRP. The ERR values obtained in terms of TDR model is about six times larger than values calculated on the basis of ICRP recommendations.

Introduction

The radionuclides released during the Chernobyl accident contaminated large areas in the southern and the eastern parts of Belarus. At the present time more than 200 000 people live in regions where the level of ^{137}Cs deposition density is higher than 185 kBq/m^2 . According to dose assessments [1, 2], radiation exposure of the population of the contaminated territory is characterized by low dose distribution. Doses (without the thyroid doses) received by the majority of people in the first decade after the accident were smaller than permissible dose limit for life — 70 mSv. Note that doses from external and internal exposure in the first decade are equal to about 60% and 90% of doses for life, correspondingly (see [3]).

To evaluate risks of damage at low doses an extrapolation of high dose results to low dose ones is implemented. At present the non-threshold linear theory is most often, as well as officially, used to make evaluation of radiation risks. However, experimental data accumulated during the last years show evidence against the linear extrapolation of high dose effects to low dose range (see [4, 5] and references therein). In this connection it is of interest to evaluate radiation risk for the population of the contaminated regions of Belarus by using dose-effect relationship based on recent data on radiation-induced effects. The present work gives radiation risk estimations obtained by using nonlinear dose-effect relationship derived in terms of the Two Defence Reactions (TDR) model [6] developed on the basis of modern results of radiobiological investigations. The calculation results are compared with the risk values estimated in the framework of the 1990 Recommendation of the ICRP [7].

Methods and Materials

Accumulated doses for adult residents of contaminated regions of Belarus

Estimation of radiation risk requires the knowledge of accumulated dose for residents of contaminated regions. An expression for evaluation of the average accumulated dose for adult residents of n-th settlement is written

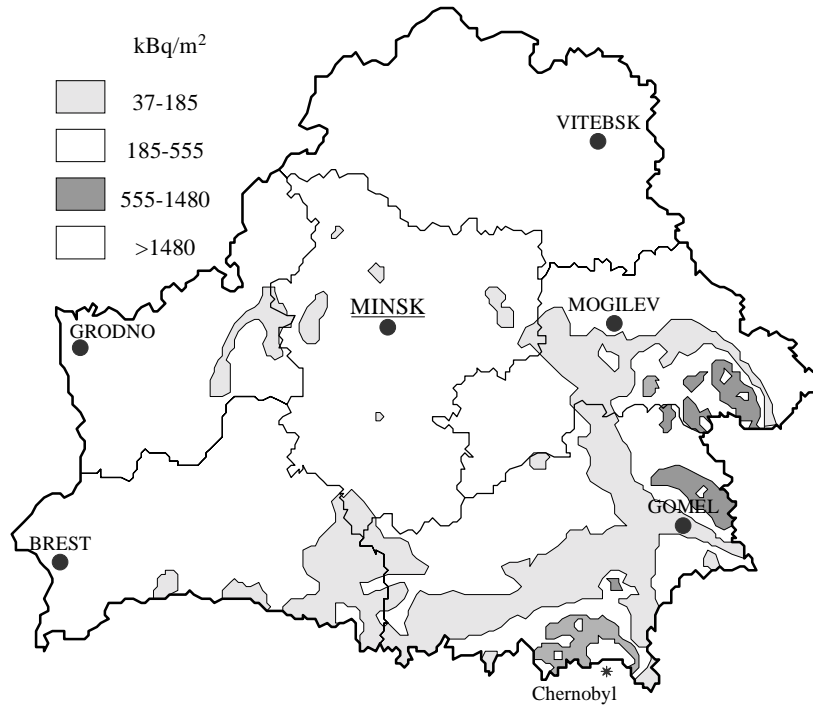

Figure 1: Belarus territory contamination with ^{137}Cs .

$$D_n(\Delta t = t_f - t_i) = \sum_{t=t_i}^{t_f} d(t)S_n(t), \quad (1)$$

where Δt is the time period after the accident ($t_i=1986$), $S_n(t)$ is the mean ^{137}Cs deposition density in the n -th settlement; $d(t)$ is average annual dose of adult population exposure normalized to ^{137}Cs deposition density. Note that according to measurement results the concentration of ^{137}Cs activity in organism of adult inhabitants is in average about 1.5 times larger than that in organism of children of 10-15 years old [8]. As a consequence, radiation doses for adult population are higher than doses for children. Estimations of $S_n(t)$ were obtained by using of empirical data on ^{137}Cs deposition density in settlements [2]. Values of the average annual normalized dose $d(t)$ for $t_i \leq 1995$ were taken from [9], and the sum of two exponents was used for fitting and extrapolating these data for $t_i > 1995$.

The distribution of ^{137}Cs deposition density as of 01.01.1995 on the territory of Belarus is shown in Fig. 1. One can see that the contaminated territory consists of the southern and the eastern regions (spots). It is necessary to note that the regions mentioned above are characterized by different values of normalized dose $d(t)$. The southern spot, closely situated to Chernobyl NPP, includes the Belorussian Polesie area, where coefficients of ^{137}Cs transfer from soil to agricultural plants are several times larger than the coefficients obtained for other contaminated regions. Therefore the doses from ^{137}Cs peroral intake and respectively normalized average annual dose for residents of the southern contaminated region are larger than doses in the eastern region (see [9]).

Taking into account the mentioned dose difference, calculations of accumulated dose $D_n(\Delta t)$ were carried out separately for adult residents of the southern and eastern contaminated regions. Values of the accumulated dose $D_n(\Delta t)$ estimated for the case of ^{137}Cs deposition density $S_n(t) = 370 \text{ kBq/m}^2$ are shown as example in Fig. 2. Dash line corresponds to the accumulated dose calculated by multiplying Δt by constant value of the permissible annual dose of exposure for population (1 mSv per year) (see [7]). According to Fig. 2, doses accumulated by inhabitants of the eastern and the southern contaminated regions during the first five years after the accident are about 5 and 10 times higher, correspondingly, than

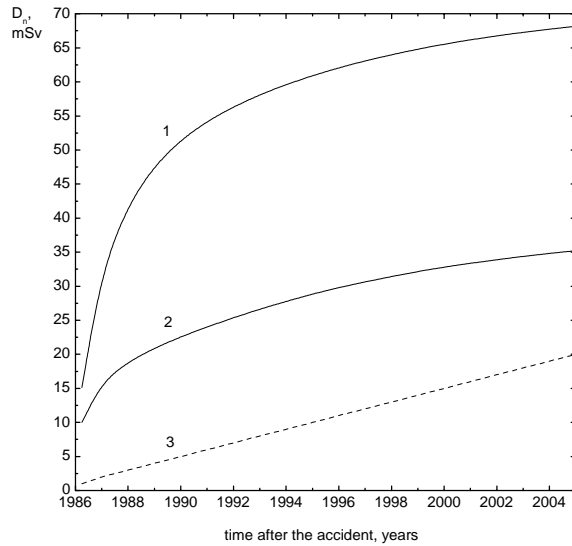

Figure 2: Accumulated doses D_n for residents of the southern (1) and the eastern (2) regions with ^{137}Cs deposition density $S_n(t) = 370 \text{ kBq/m}^2$. Dash line (3) corresponds to the permissible annual dose: 1 mSv [7].

permissible level 5 mSv; doses for the 15 years period are about 2(4) times higher than permissible level 15 mSv.

The results show that about 80% of dose accumulated for the 15-years period were taken during the first five years after the accident. It means that the intensity of exposure in first years after the accident was several times higher than permissible level.

Using assessments of $D_n(\Delta t)$ and the population data of settlements, distributions of accumulated doses for $\Delta t = 5, 10, 15$ years were deduced for adult residents of the southern and the eastern regions where the level ^{137}Cs contamination is more than 37 kBq/m^2 (see Fig. 3). Note that the percentage of adult population in settlements was supposed to be constant for the period under consideration. The number of them are 103,680 and 153,380 in the southern and the eastern regions, respectively (see [2]). According to calculation results, average values of the accumulated dose for residents of the southern region are about 30% higher than those for the eastern region. As it is shown in Fig. 3, the dose accumulated during ten-years and fifteen-years periods following the accident are about 20% and 25% larger than dose for the first five-years period, correspondingly. In the second five-years period the average annual increase of the dose was about 1.3 mSv/y. During the third 5-years period the dose increase rate was about two times smaller: 0.6 mSv/y.

Dose-effect relationship and radiation risk estimation in terms of model of Two Defence Reactions

Dose-effect relationship (DER) is the basis of radiation risk evaluation. Presently the official form of DER is the linear non-threshold (LNT) relationship, which was accepted by UNSCEAR [10] and ICRP [7]. It is the foundation for all present-day norms, standards and rules of radiation safety. In the formulation of UNSCEAR, the main merits of LNT hypothesis are its simplicity and agreement with most concepts and numerical data. At the same time modern results of epidemiological observations and radiobiological researches show difference between a variety of DERs obtained for stochastic radiobiological effects at low dose range (see, for example [11]). The epidemiological data of the survey of Japanese survivors cohort prove the non-linear dependence of the excess of the relative risk on dose at low range [12, 13]. It is very likely that DER depends on kind of radiation damage, type of biological

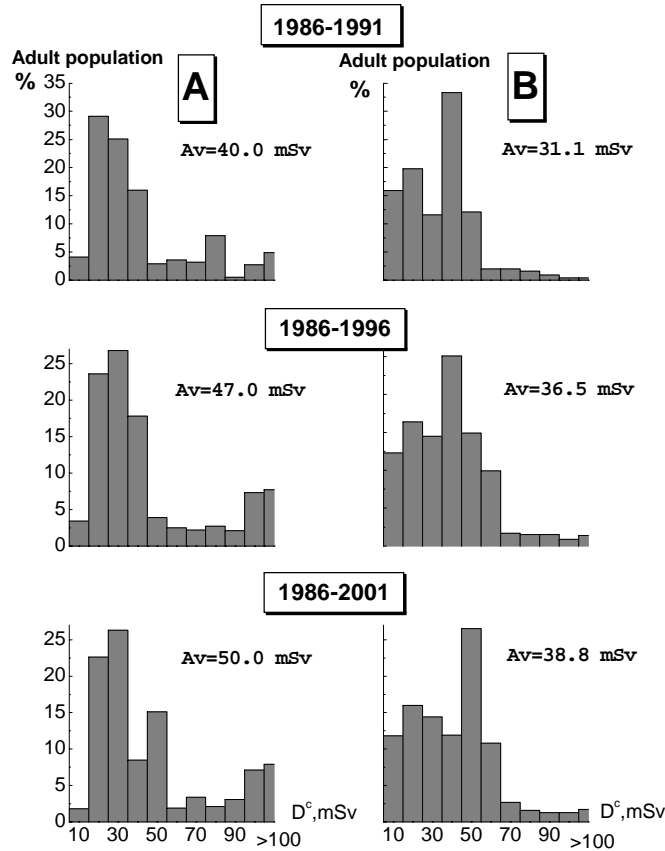

Figure 3: Distributions of accumulated doses for adult residents of the southern (A) and the eastern (B) contaminated regions.

object and exposure conditions.

In this paper the Two Defence Reactions (TDR) model [6] was used for radiation risk assessment. The basis of the choice are the results of the observations of low dose radiation damages in cells of different biological objects: HT29 human lines [14], V79 Chinese hamster lines [11] and root meristem of barley grains [15]. The results obtained in the above mentioned works show nonlinear increase of damage with dose growth (see Fig. 4–7). Data presented in these figures were treated in the framework of TDR model [16]. According to the results, TDR model satisfactorily describes DERs for considered biological objects.

The TDR model is based on the assumption that the cell response to irradiation is regulated by constitutive and adaptive mechanisms. On the level of organism the response of the immune system to irradiation also consists of two components: innate and adaptive. The defence reaction at the organism level acts in addition to the cell level defence. The differential equations describing interaction of two components of defense system are similar for both the cell and the organism levels. Curves in Fig. 4–7 are obtained through the fitting procedure of observed DERs by using the function found by solving the TDR model equations.

Taking into account the results of TDR model application for description of DERs, the excess of the relative risks (ERR) for the population of the contaminated regions of Belarus was estimated on the basis of this model and on the dose distributions given in Fig. 3. The ERR for the group of N residents is

$$ERR_N = \frac{\sum_i ERR_i N_i}{\sum_i N_i} = \frac{\sum_i ERR_i N_i}{N}, \quad (2)$$

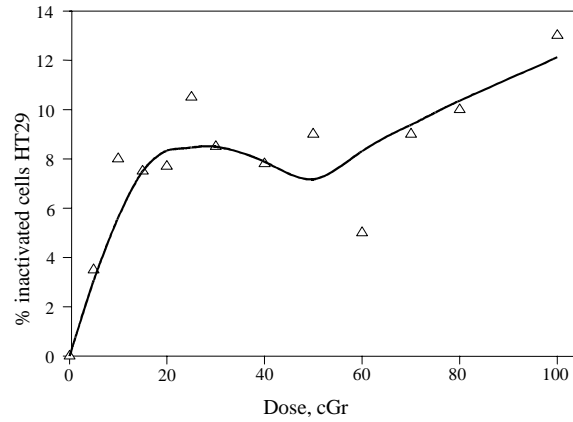

Figure 4: Dependence of the yield for human tumor inactivated cells of HT29 line on X-ray dose [14].

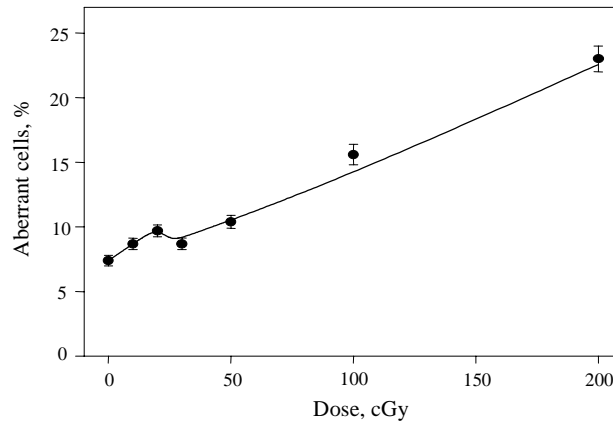

Figure 5: Dependence of the frequency of Chinese hamster cells with chromosome aberrations on γ -radiation dose from ^{60}Co [11].

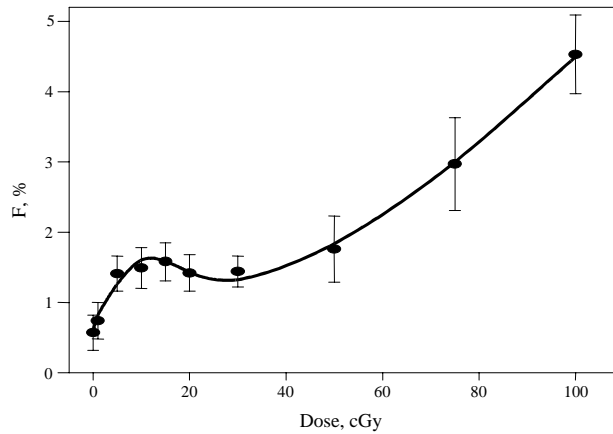

Figure 6: Dose-effect relationship in root meristem cells of barley grains. F - output of aberrant cells [15].

where ERR_i is the excess of the relative risk for i-th subgroup of residents irradiated with the dose H_i . According to the TDR model,

$$ERR_i = \frac{(1 - W_c)(1 - f_i)}{W_c}, \quad (3)$$

where W_c is the spontaneous risk of mortality from cancer without irradiation (background), accepted to be 0.28 [12], and function f_i is determined as:

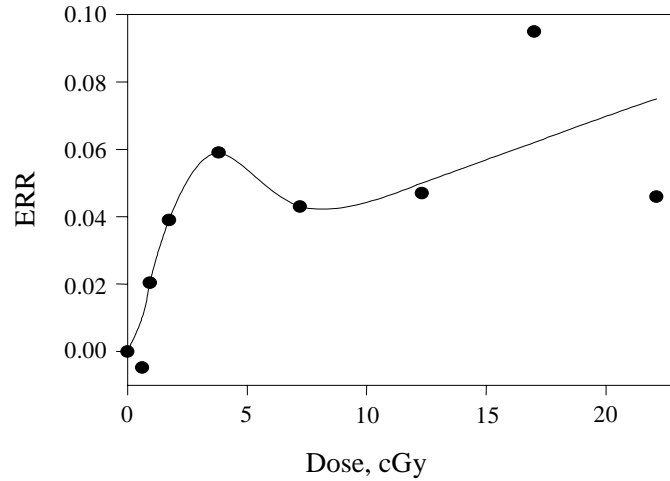

Figure 7: Excess of the relative risk (ERR) of mortality from all cancer other than leukemia for Japanese A-bomb survivors (men) who were 20-40 years old at the time of bombing [6].

$$f_i = \exp(-\mu_n H_i) + \frac{\nu \mu_n}{\mu_n - \mu_a} \{ \exp[-\mu_a (H_i - H_t)] - \exp[-\mu_n (H_i - H_t)] \}, \quad (4)$$

with $(H_i - H_t) \geq 0$ (see [6]).

The model parameters μ_n , μ_a , ν , H_t are found from the best description of empirical risk data by the TDR model. Parameters μ_n and μ_a characterize two types of defence (response) reaction of biological objects: constituent (or innate) and adaptive (or inducible) radiosensitivities, correspondingly. The parameter ν characterizes capabilities of the adaptive protective mechanism. The dose H_t is the threshold of inducible reparations action. Various ranges for the mentioned characteristics are considered in [16].

Epidemiological data for adult survivors of Hiroshima and Nagasaki, who were 20–40 years old at the time of atomic bombing [4], were treated in the framework of TDR model for evaluating the model parameters. The fitting results of ERR of mortality from all types of cancer except leukaemia for Japanese survivors are presented in Fig. 7. One can see that the magnitude ERR is characterized by non-linear growth at low dose range. The behavior of ERR is similar to the dose-effect relationships observed in cells (see Fig. 4–6).

Results and Discussion

Obtained model parameters were used for the assessments of ERR of cancer mortality for the adult residents of the contaminated regions of Belarus on the basis of accumulated doses $D_n(\Delta t)$. The results of calculation of the excess of radiation risk for residents of the southern and the eastern regions are presented in the Table 1 in comparison with the values obtained in the framework of ICRP recommendations.

The results show that excess of the relative risk of cancer mortality for the adult residents of contaminated regions of Belarus as a result of Chernobyl accident is about 5–6% during the whole life. The main contribution to ERR was provided by the doses accumulated during the first five years after the accident; further increase of ERR is 10–15%. The difference between ERR values predicted for the southern and the eastern contaminated regions is smaller than 10%. ERR values obtained in terms of TDR model is about six times larger than values calculated on the basis of ICRP recommendations [7].

On the basis of the ERR assessments obtained in terms of TDR model the average annual excess of cancer mortality for adults can be estimated as $6\% / 50 \text{ years} \cong 0.1\%$ in a year. As the excess of cancer mortality is proportional to excess of cancer morbidity the average annual excess of cancer morbidity is expected about 0.1%. Statistical data on cancer incidence in Belarus for the period 1991-2000 (see [17])

Table 1: The excess of the radiation risk (ERR) for the residents of the southern (A) and the eastern (B) regions.

Model	Period after the accident, years				
	5	10	15	20	
A	TDR	0.0554	0.0590	0.0610	0.0620
	ICRP 1990	0.0093	0.0106	0.0112	0.0113
B	TDR	0.0504	0.0553	0.0578	0.0582
	ICRP 1990	0.0077	0.0087	0.0092	0.0093

show that the average annual excess of cancer morbidity among adult residents of contaminated regions is about 1.2%. Note that the same excess of cancer morbidity was observed for uncontaminated regions. So according to assessments evaluated by using of ERR estimations and data from [17] one might expect that the contribution of the Chernobyl accident to annual excess of cancer morbidity would be about 10%. It should be stressed that the latent period for solid cancers is about 10 years and the annual excess of cancer morbidity increases with age. On this reason the mentioned value of the Chernobyl contribution to cancer morbidity for the period 1991–2000 would be considered as overestimated assessment.

It is necessary to note that the quantity ERR in question is general index including all types of solid cancer. An excess of some types of cancer, which are characterized by the small weight coefficient, may be considerably larger than the above-mentioned assessments. For example, in the period 1991–2000 the thyroid cancer morbidity of the population of the eastern contaminated region increased about 7 times (see [17]). For this reason it is of great interest to perform long-term epidemiological investigations in Belarus to deduce dose-risk relationship for some types of cancer.

Conclusion

Accumulated doses for adult residents of contaminated regions of Belarus were calculated for different periods after the Chernobyl accident. The results show that about 80% of dose accumulated for the 15-years period were taken during the first five years after the accident. Distributions of accumulated doses were deduced for adult population of the southern and the eastern contaminated regions. Average values of the accumulated dose for residents of the southern region are about 30% higher than those for the eastern region.

Modern data of epidemiological observations of Japanese survivors cohort and radiobiological researches of low dose damages in cells of different biological objects were analysed in terms of Two Defence Reactions (TDR) model. The results show that this model satisfactorily describes non-linear dose-effect relationships for considered biological objects. The TDR model parameters obtained by treating of data on mortality of adult survivors of Hiroshima and Nagasaki were used for calculation of the excess of the relative risk for adult residents of contaminated regions of Belarus on the basis of the accumulated dose distributions. The results show that the excess of the relative risk of cancer mortality as a result of Chernobyl accident is about 5–6% during the whole life. ERR values obtained in terms of TDR model is about six times larger than values calculated on the basis of ICRP recommendations.

References

- [1] Catalog of Exposure Doses for Citizens of Settlements of Republic of Belarus, Minsk (1992), (in russian).
- [2] Catalog of Annual Exposure Doses for the Population of Belarus. Report of the Institute of Radiation Medicine and Endocrinology, Minsk (1995), (in russian).
- [3] Levels of Irradiation and Effects as a Result of Chernobyl Accident. Report of ICEAR-2000, Application 7, Moscow, 41 (2001), (in russian).

- [4] M. M. Komochkov, *On Similarity of Dependences of the Dose-Stochastic Radiobiological Effect at Cell and Organism Level*. Preprint of JINR, P19-99-78, JINR, Dubna (1999), (in russian).
- [5] E. A. Krasavin, R. D. Govorun, *Radiobiological Research in JINR*. Preprint of JINR, P19-2000-245, JINR, Dubna (2000), (in russian).
- [6] M. M. Komochkov in *Fundamentals for Assessment of Risks from Environment Radiation. "A Model of Two Reactions as Dose-Stochastic Radiological Effect Relationship and Estimation of Radiation Risks"* edited by C. Baumstark-Khan et al. (Kluwer Academic Publishers, Netherlands, 1999), pp. 25–34.
- [7] *International Commission on Radiological Protection. 1990 Recommendation of the ICRP*, Pub. 60, Vol. 21, No. 1–3 of Annals of the ICRP (Pergamon Press, Oxford, 1990).
- [8] *Health Consequences of the Chernobyl Accident. Scientific Report. International Programme on the Health Effects of the Chernobyl Accident (IPHECA)* edited by G. N. Souchevich and A. F. Tsyb (World Health Organisation, Geneva, 1996), p. 219.
- [9] V. F. Minenko, V. V. Drozdovich, S. S. Tretyakevich, A. V. Ulanovskiy in *Analytical and informational bulletin "Medical and biological aspects of ChNP accident". "Irradiation of Population of Belarus after the Chernobyl Accident: Collective Doses and Prognosis of Stochastic Effects"*, 50 (1996), (in russian).
- [10] *Report of United Nations Scientific Committee on the Effects of Atomic Radiation, Medical Radiology and Radiation Safety*, **46**, 28 (2001), (in russian).
- [11] N. L. Shmakova, E. A. Fadeeva, E. A. Krasavin, M. M. Komochkov, O. A. Abouzeid, *Cytogenetic Effects of Low Dose Radiation in Chinese Hamster Cells*, *Nucleonika*, **44**, 539 (1999).
- [12] D. A. Pierce, Y. Shimuzu, D. L. Preston, M. Vaeth, K. Mabuchi, *Studies of the Mortality of Atomic Bomb Survivors. Report 12, Part I. Cancer: 1950–1990*. *Radiation Research*, **146**, 1 (1996).
- [13] D. L. Preston in *Proc. of an International Conference on Low Doses of Radiation: Biological Effects and Regulatory Control. Invited papers and discussions. "Low Dose Radiation and Human Health. Risk Estimates"*, (IAEA, Vienna, 1998), p. 217.
- [14] M. C. Joiner, P. Lambin, E. P. Malaise et al, *Mutation Research*, **538**, 171 (1996).
- [15] S. A. Geraskin, V. G. Dikarev, A. A. Udalova, N. S. Dikareva, *Regularities of Induction by Low Doses of Ionizing Radiation of Cytogenic Damages in the Cells of Barley Root Meristem*. *Radiation Biology. Radioecology*, **39**, 373 (1999), (in russian).
- [16] M. M. Komochkov, *Dose Dependence on Stochastic Radiobiological Effects in Radiation Risk Estimation*. Preprint of JINR, E19-99-295, JINR, Dubna (1999).
- [17] Belarussian Cancer Registry. *Malignant Neoplasms in Belarus: 1991–2000*, Minsk (2001).

Estimation of Thyroid Doses from Inhalation of ^{131}I for Population of Contaminated Regions of Belarus

Vladimir A. KNATKO and Inga N. DOROZHOK

*The Institute of Radiobiology, National Academy of Sciences,
Kuprevich Str-2, 220141, Minsk, Republic of Belarus: V_Knatko@radbio.bas-net.by*

Abstract

Based on the relationships between ^{131}I and ^{137}Cs content in soil samples and the data on ^{137}Cs contamination of settlements, the ^{131}I deposition density $S_n(^{131}\text{I})$ was estimated for the settlements located in the eastern and the southern areas of Belarus (1,079 and 316 settlements, respectively). The results show that the 90% interval of the $S_n(^{131}\text{I})$ quantity is about 500 - 2,300 kBq/m² and 700 - 3,500 kBq/m² for the eastern and the southern area, respectively. Using assessments of $S_n(^{131}\text{I})$, thyroid doses from inhalation of ^{131}I were evaluated with taking into account the period and character of radioactive deposition in various parts of the areas. According to the results, the thyroid doses for adult population of the eastern and the southern areas vary from 3 to 80 mSv and from 40 to 370 mSv, respectively, while the median doses are about 20 and 130 mSv, for the eastern and the southern area, respectively. Uncertainties in the calculation of thyroid doses, due to the procedure applied, were discussed.

Introduction

The data on cancer incidence rates accumulated in Belarus after the Chernobyl accident [1] show a statistically significant increase in the number of thyroid cancer, especially among the children. According to [1], in period 1991-2000 standardized incidence rate for thyroid cancer increased from 3.6 up to 9.2 per 100 000 population (about 2.6 times). The fast increase of thyroid cancer cases evoked interest to the problem of thyroid dose assessment. The individual thyroid dose estimations in Belarus were derived primarily from the results of direct ^{131}I thyroid measurements carried out in May and June of 1986 [2]. Note that ^{131}I is the most important radionuclide that caused serious thyroid exposures in the affected areas in the first few weeks following the accident. Thyroid cancers risk assessments obtained in the framework of the ICRP recommendations by using the doses derived from thyroid measurements show an excess of observed thyroid cancer cases over the expected number [3]. In this connection the assessment of thyroid doses from inhalation and ingestion of ^{131}I is of interest for a prediction of radiological consequences by the Chernobyl accident.

The measurements of ^{131}I activity in thyroid of people and determination of ^{131}I concentration in food stuffs and air were accomplished only in part of the contaminated territory. In order to evaluate the thyroid doses for the population of those regions where no monitoring was performed, a procedure based on reconstruction of ^{131}I deposition density can be applied. Using the ^{131}I - ^{137}Cs relation obtained in [4] and the data on ^{137}Cs contamination of settlements (see [5]) the ^{131}I deposition density was evaluated in the present paper for settlements placed in the eastern and the southern areas of Belarus (see Fig.1). Based on these assessments thyroid doses from inhalation intake of ^{131}I were obtained for adult population.

Reconstruction of ^{131}I Deposition Density

The estimates of ^{131}I deposition density were calculated on the basis of the relationship between ^{131}I and ^{137}Cs activity concentration in soil samples taken in the contaminated regions under consideration [4].

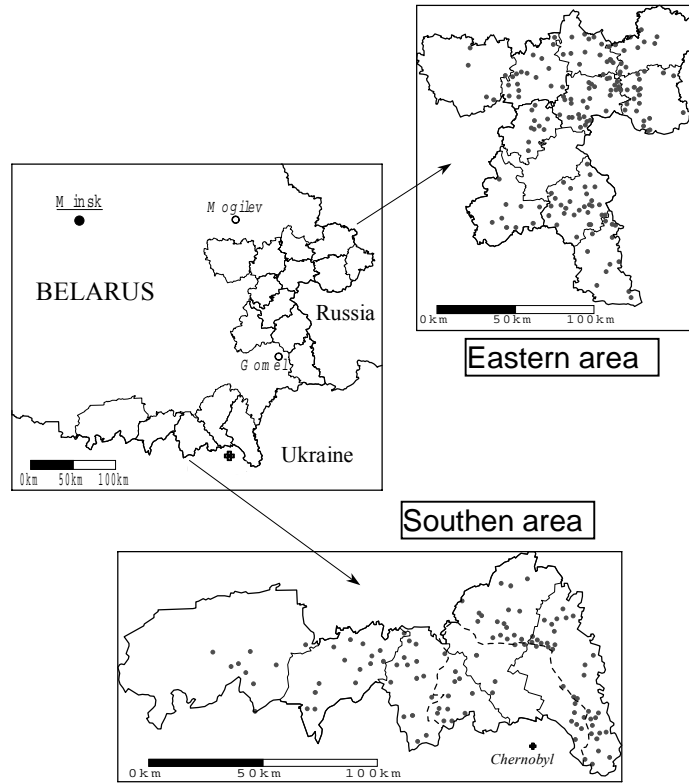

Fig. 1. Areas under investigation.

The points show settlements where soil samples were taken. Dot line within the southern area shows the boundary of the Polesskiy state radioecological nursery (the zone of evacuation).

Note that the relationship had been deduced in [4] with taking into account the contribution of ^{137}Cs global fallout that is about 2.2 kBq/m^2 . The regression function describing the data for the contaminated regions was written in form:

$$^{131}\text{I} = A_k \cdot [^{137}\text{Cs}]^{B_k} \quad (1)$$

where the radionuclides activity in soil is expressed on May 10, 1986, and the parameters A_k and B_k are characterized by the following values: $A_1=33.8 \text{ kBq/m}^2$, $B_1=0.63$ and $A_2=69.4 \text{ kBq/m}^2$, $B_2=0.59$ for the eastern ($k=1$) and the southern ($k=2$) area, respectively. Starting from the expression (1), the mean density of ^{131}I deposition $S_n(^{131}\text{I})$ in the territory of the n -th settlement situated in the studied areas was obtained by using the formula:

$$S_n(^{131}\text{I}) = A_k \cdot [S_n(^{137}\text{Cs})]^{B_k} \quad (2)$$

where $S_n(^{137}\text{Cs})$ is the level of settlement contamination with ^{137}Cs . Empirical values of $S_n(^{137}\text{Cs})$ expressed on May 10, 1986 were taken from [5].

It should be noted that the settlements situated in the territory of the zone of evacuation (see Fig.1) were not included in the present calculations of $S_n(^{131}\text{I})$. Population of the evacuation zone was removed during the first week of May 1986 when the radioactive release still continued. Dose estimation for removed inhabitants needs special consideration taking into account a day of evacuation.

The distributions of values $S_n(^{131}\text{I})$ calculated for 1,079 and 316 settlements situated in the eastern and the southern areas, respectively, are presented in Fig.2 in comparison with the distributions of empirical data on $S_n(^{137}\text{Cs})$. According to the results, the values of $S_n(^{137}\text{Cs})$ and $S_n(^{131}\text{I})$ are described by a lognormal distribution:

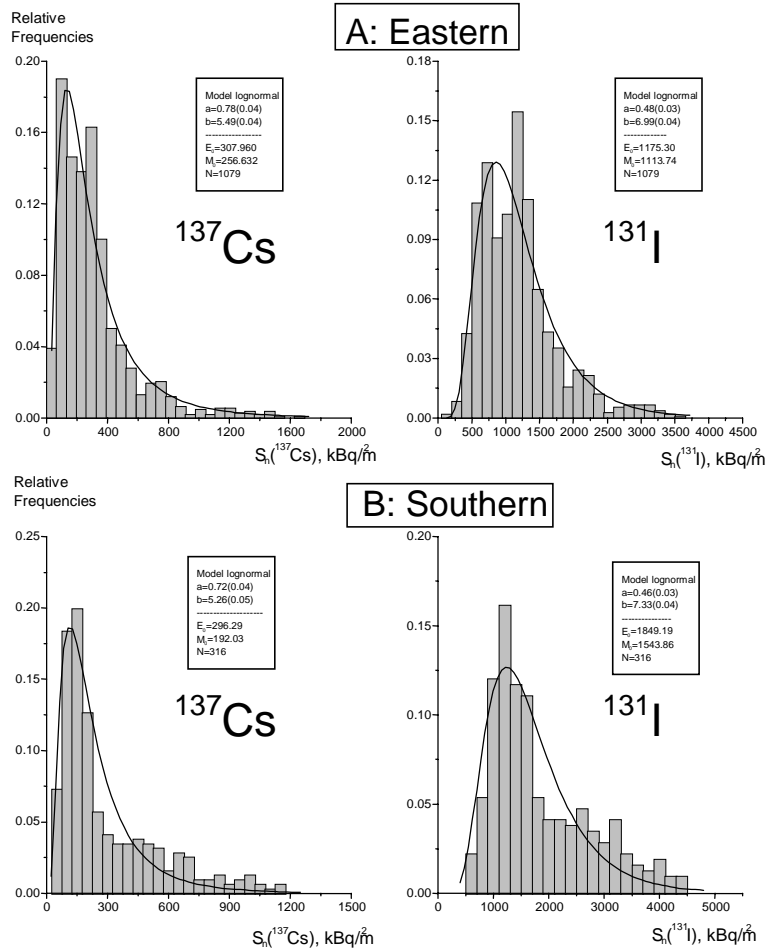

Fig. 2. Distributions of ^{137}Cs contamination level and the estimated ^{131}I deposition density for settlements situated in the eastern (A) and the southern (B) areas of Belarus.

$$f(x) = \frac{\exp[-(\ln x - b)^2 / 2a^2]}{2\pi ax} \quad (3)$$

The parameter a in (3) characterizing skewness of the distribution is defined as $a = [2(\ln E - \ln M)]^{1/2}$, where E is the average, and $M = \exp(b)$ is the median of the distribution. The analysis of the distribution parameters shows that the median value of $S_n(^{137}\text{Cs})$ obtained for the settlements situated in the eastern area is about 35% larger than in case of the southern area. At the same time the variation $V = \sigma/E = (e^{a^2} - 1)^{1/2}$ of values $S_n(^{137}\text{Cs})$ takes the close values for the studied areas. Note that in accordance with [6] the quantity of variation of radionuclide deposition density reflects the heterogeneity of Chernobyl fallout.

According to the distribution parameters derived (see Fig.2), the median value of $S_n(^{131}\text{I})$ obtained for the settlements situated in the southern area is about one third larger than in case of the eastern area. The 90% interval of the $S_n(^{131}\text{I})$ quantity is about 500 - 2,300 kBq/m² and 700 - 3,500 kBq/m² for the eastern and the southern area, respectively. The comparison of the distribution characteristics given in Fig.2 shows that the ratio of median values $R_{med} = \text{med}[S_n(^{131}\text{I})] / \text{med}[S_n(^{137}\text{Cs})]$ for the eastern area is about 1.8 times smaller than for the southern area. It should be stressed that the present values of $S_n(^{131}\text{I})$

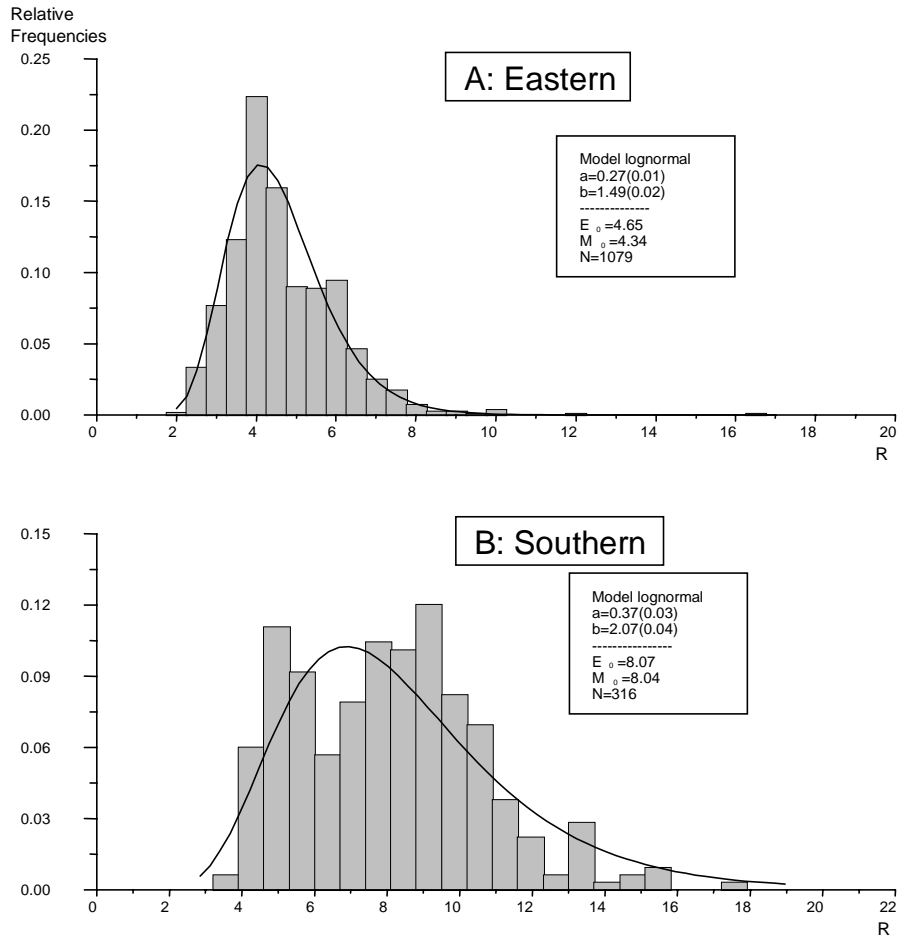

Fig. 3. Values of the ratio $R=S_n(^{131}\text{I})/S_n(^{137}\text{Cs})$ obtained for settlements situated in the eastern (A) and the southern (B) areas.

were obtained by using the radionuclides activities expressed on May 10, 1986.

The distributions of the isotope ratio $R = S_n(^{131}\text{I})/S_n(^{137}\text{Cs})$ are given in Fig.3. According to the results, about 90% of ratio values obtained for the eastern area range between 3 and 7. In case of the southern area the quantity R takes a value mainly in the interval $4 < R < 13$. The estimations of R agree with the isolines of the isotope ratio $^{131}\text{I}/^{137}\text{Cs}$ in the Chernobyl fallout at Belarus territory (see [7]). The observed difference between isotope ratio $^{131}\text{I}/^{137}\text{Cs}$ in deposition of Chernobyl radionuclides can be caused by several factors, in particular, various gaseous and aerosol iodine fractions in radioactive discharges of the Chernobyl NPP as well as the deference of wash-out rate between aerosol and gaseous iodine (see [8]).

Evaluation of Thyroid Dose from Inhalation of ^{131}I

Thyroid doses from inhalation intake of ^{131}I were estimated in a framework of the approach described in [9]. The formula used for calculation of the inhalation dose D was written as

$$D = d \cdot A = d \cdot f \cdot C \cdot r \cdot t, \quad (4)$$

where d is committed effective or organ dose equivalent per unit intake via inhalation, A is activity intake over the time period t , C is the mean activity concentration of radionuclide in air, r is inhalation rate, and f is the shielding factor of inhabitants. The values of quantities d and r for different age groups of population are presented in [10] and [11], respectively. Following to [9] it was conservatively assumed for the purposes of dose assessment that $f = 1$.

The radionuclide concentration in air C was estimated on the basis of the data on deposition density S , deposition velocity v , and the time period of deposition T

$$C = \frac{S}{v \cdot T}. \quad (5)$$

According to the data presented in [12], in general the contamination of air in the southern area continued for nine days. About 90% of ^{131}I activity fell out during the period 8:00 April 26 - 8:00 April 29, 1986. The territory of the eastern area was contaminated by radioactive fallout mainly in two days, namely 8:00 April 27 - 8:00 April 29. The fraction of ^{131}I activity which fell out during the pointed period on the territories of different administrative districts situated in the eastern area range from 75% to 95%. The contamination of the eastern area persisted until May 10, 1986.

Data from [12] show different characteristics of radioactive deposition among the areas under consideration. The territory of the southern area was contaminated by dry deposition, whereas wet deposition prevailed in the eastern area. The contribution of wet deposition to the overall contamination of territory of several districts in the eastern area was about 75%. The velocity values of dry ($v_d = 0.4$ cm/s) and wet ($v_w = 3.0$ cm/s) deposition of ^{131}I used in the present work were taken from [13].

The expression for evaluation of settlement contamination with ^{131}I is written as

$$S_n(^{131}\text{I}) = \sum_{t_m} S_n(t_m) \cdot k(t_m), \quad (6)$$

where $S_n(^{131}\text{I})$ is the density of ^{131}I deposition at the territory of the n -th settlement on May 10, 1986, $k(t_m) = \exp(-\Delta t_m / \tau)$, $\Delta t_m = t_f - t_m$ is the period from the final day (t_f) of deposition (i.e. May 10, 1986) and the m -th day of deposition, and τ is half-life time of ^{131}I . In order to use the data on daily deposition of ^{131}I the quantity $S_n(t_m)$ was expressed

$$S_n(t_m) = a(t_m) \cdot \sum_{t_m} S_n(t_m), \quad (7)$$

where $a(t_m)$ is daily fraction of summarized deposition activity of ^{131}I . The values of $a(t_m)$ characterizes daily variation of ^{131}I deposition in the period April 26 - May 10, 1986 (see [14]). Taking into account expressions (6) and (7) the relationship between $S_n(^{131}\text{I})$ and $\sum_{t_m} S_n(t_m)$ is written as

$$\sum_{t_m} S_n(t_m) = S_n(^{131}\text{I}) / [\sum a(t_m) \cdot k(t_m)]. \quad (8)$$

On the basis of Equations (4) - (8), the expression for estimation of thyroid dose from daily ($t = T = 1$ day) inhalation of ^{131}I was defined as

$$D_n(t_m) = d \cdot f \cdot r \cdot h \cdot S_n(^{131}\text{I}) / v(t_m), \quad (9)$$

where $h = a(t_m) / [\sum a(t_m) \cdot k(t_m)]$. Distributions of $S_n(^{131}\text{I})$ values used for dose calculations are given in Fig.2. Starting from equation (9), the doses from inhalation during the main period of radioactive deposition $\Delta t = \text{April 26} - \text{May 10, 1986}$ were estimated as a sum of doses from daily inhalation intake of ^{131}I :

$$D_n(\Delta t) = \sum_{t_m} D_n(t_m). \quad (10)$$

Results and Discussion

The calculation results show (see Fig.4) that thyroid dose equivalent for adult population of the areas under investigation varies from a few to a few hundreds of mSv. Dose values obtained for 95% of the settlements situated in the eastern and southern the areas are smaller than 45 and 300 mSv, respectively. The maximal dose is about 80 mSv in the eastern area and about 370 mSv in the southern area. The

median value characterizing the dose distribution obtained for the southern area is about 6 times larger than in case of the eastern area. The computations of thyroid dose for children show that the dose assessments obtained for children of 10 years old are 1.8 times larger than the results for adult population. It should be emphasized that present dose assessments correspond to conservative (largest) value of the factor f . Note that thyroid doses from inhalation intake of ^{131}I are smaller than doses from ^{131}I intake with foodstuff. According to [12], ^{131}I intake with cow milk evaluated for adult residents of settlements located in Gomel district (southern area in our case) are higher than 500 mSv.

It should be emphasized that the present dose estimation based on the relationship between ^{131}I and ^{137}Cs activities in soil does not take into account local features of ^{131}I deposition and inhalation. As a result the spatial distributions of the reconstructed ^{131}I deposition densities $S_n(^{131}\text{I})$ and the thyroid doses D_n are similar to the distribution of the ^{137}Cs contamination levels of the settlements $S_n(^{137}\text{Cs})$ in the area of investigation. In particular, two maxima revealed in the statistical distribution of dose D_n calculated for population of the eastern area may be caused by the peculiarities of location of settlements in this area (see Fig.2 and Fig.4).

Based on the expressions (9) the behavior of the normalized thyroid dose $D_n^0 = D_n / S_n(^{137}\text{Cs})$ can be modeled by the power function, which is simply deduced using the isotope ratio $R = S_n(^{131}\text{I}) / S_n(^{137}\text{Cs})$:

$$D_n^0 \propto [S_n(^{137}\text{Cs})]^{C_k} \quad (11)$$

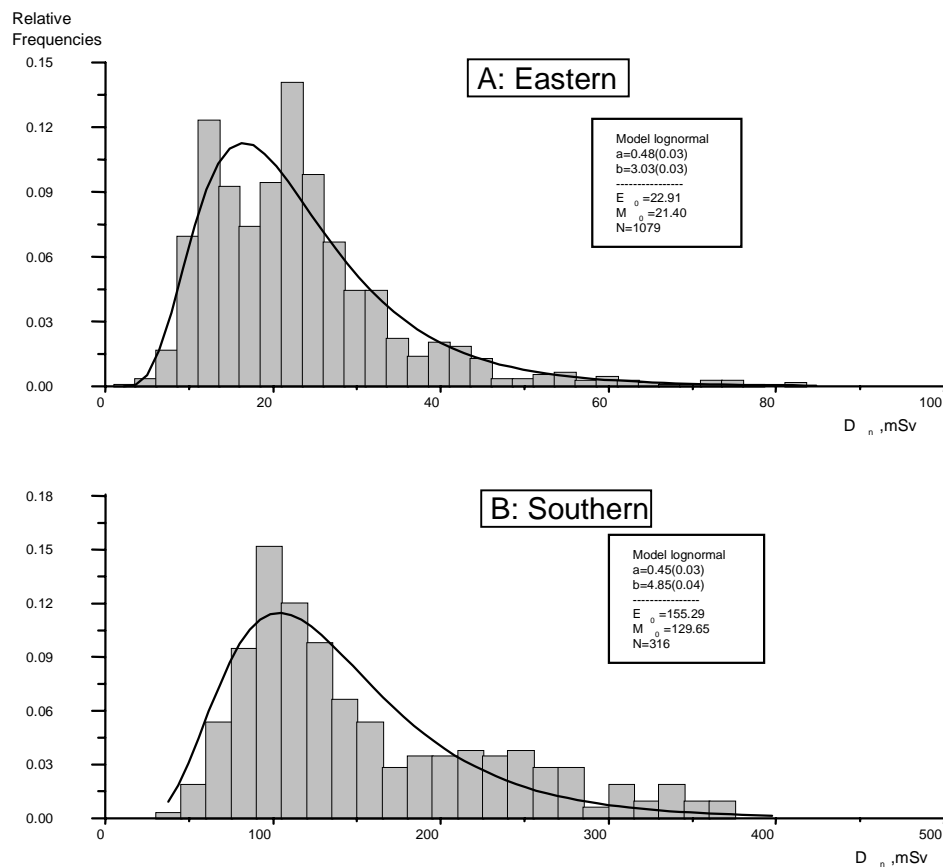

Fig. 4. Distributions of thyroid dose D_n from inhalation of ^{131}I calculated for adult population of the settlements located in the eastern (A) and the southern (B) areas.

where $C_k = B_k - 1 < 0$ (see (1)). According to equation (11), the normalized dose D_n^0 decrease with increasing of ^{137}Cs contamination density. Equation (11) can partly explains the decreasing trend in the normalized mean values of thyroid dose measured for population of 70 settlements with the increase of the ^{137}Cs contamination level [2].

The present estimats of thyroid dose from inhalation of ^{131}I are associated with uncertainties arising from different sources. One of them is the ^{131}I deposition velocity v depending on type of deposition (wet or dry). No data about the quantity v in the areas of investigation are available. For this reason the velocity values $v_w = 3.0$ cm/s and $v_d = 0.4$ cm/s derived in [13] for radioactive deposition were used for the present calculation. The value 3.0 cm/s agrees with estimation 2.6 cm/s (the difference is about 15%) obtained for velocity of ^{131}I wet deposition in the town Obninsk situated on the territory of Kaluga region (Russia) bordering upon the eastern area under investigation (see [15]). The velocity value for dry deposition (0.4 cm/s) is two times larger than estimation 0.2 cm/s derived in the measurements carried out in the Research Center of Seibersdorf (Eastern Austria) in April-July 1986 [8]. Considering that the radionuclide concentration in air is directly related with deposition velocity, the value of deposition velocity would be the important source of uncertainty in dose estimation, in particular for the southern area where dry deposition was dominant.

The next source of uncertainties is dose dependence on the period of ^{131}I deposition. In this connection it should be noted that the previous thyroid dose estimation for population of the eastern area (see [16]) was carried out in proposal of constant daily wet deposition of ^{131}I during April 28 - May 2, 1986. The comparison of the dose distribution given in Fig. 4 with data from [16] shows that dose values obtained in [16] in average are about 20% smaller than the present estimations. The similar uncertainties in dose estimation can be caused by errors in the parameters A_k and B_k characterizing the relationship between ^{131}I and ^{137}Cs deposition densities, or errors in the level of settlements contamination with ^{137}Cs (see [16]). Note that despite the uncertainties mentioned above, the assessment of ^{131}I deposition density and thyroid exposure based on the procedure described seems reasonable taking into consideration the lack of empirical data on ^{131}I content in air and soil.

Conclusion

Using the relationships between ^{131}I and ^{137}Cs activity concentration in soil samples and the data on the level of settlements contamination with ^{137}Cs , the ^{131}I deposition density $S_n(^{131}\text{I})$ was evaluated for the settlements situated in the territory of the eastern and the southern areas of Belarus. The results show that the median values of $S_n(^{131}\text{I})$ obtained for settlements located in the eastern and the southern area are about 1.1 and 1.5 MBq/m², respectively.

Based on the assessments of $S_n(^{131}\text{I})$ thyroid doses from inhalation of ^{131}I were calculated for adult population of the studied areas. The results show that thyroid doses D_n for population of the eastern area change in region $3 < D_n < 80$ mSv. In case of the southern areas the dose values vary from 40 to 370 mSv. The median doses are about 20 and 130 mSv, for population of the eastern and the southern area, respectively. The observed difference between doses is caused mainly by different character of ^{131}I deposition in the studied areas.

The values of thyroid dose normalized to the level of settlement contamination with ^{137}Cs tend to decrease with increasing ^{137}Cs deposition density. This tendency in behavior of the normalized dose reflects the non-linear relationship derived between ^{131}I and ^{137}Cs concentration in soil.

The results of the present estimation of ^{131}I deposition density and thyroid doses from inhalation of ^{131}I will be included in wide-scale computations of thyroid dose for population of the contaminated regions of Belarus.

References

1. Belarusian Cancer Registry. Ministry of Health of Belarus, Minsk (2001).
2. Yu.I.Gavrilin, V.T.Khrouch, S.M.Shinkarev, N.A.Krysenko, A.M.Skryabin, A.Bouville and L.R.Anspaugh, Chernobyl Accident: Reconstruction of Thyroid Dose for Inhabitants of the Republic of Belarus. *Health Physics* 76(2), 105-119 (1999).
3. Buglova E.E., Kenigsberg J.E. and Sergeeva N.V., Cancer Risk Estimation in Belarussian Children due to Thyroid Irradiation as a Consequence of the Chernobyl Nuclear Accident. *Health Physics* 71(1), 45-49 (1996).
4. V.A.Knatko, I.I.Ivashkevich, V.D.Asimova. Relationship between ^{131}I and ^{137}Cs Deposition on Soil in the Chernobyl Accident. Research Activities about the Radiological Consequences of the Chernobyl NPS Accident and Social Activities to Assist the Sufferers by the Accident. Ed. by T.Imanaka, KUR-KR-21, Kyoto University, 90-93 (1998).
5. J.E.Kenigsberg, V.F.Minenko, S.S.Tretyakevich. Catalog of Annual Exposure Doses for Population of Belarus. Report of the Institute of Radiation Medicine and Endocrinology, Minsk, 1995 (in Russian).
6. Yu.A.Izrael, and 10 others. Ecological After-Effects of Environment Contamination in Chernobyl Accident Area. *Atom. Energ.* 64(19), 28-40 (in Russian) (1988).
7. Retrospective Dosimetry and Dose Reconstruction. Experimental collaboration project №10, Final report. Eds. I.K.Bailiff and V.Stepanenko. European Commission, Brussels, 38, (1996).
8. K.Mueck. Variations in Activity Concentration and Radionuclide Ratio in Air After the Chernobyl Accident and its Relevance to Inhalation Dose Estimates. *Radiat. Prot. Dosim.* 22(4), 219-229 (1988).
9. V.A.Knatko, A.Mayall, M.A.Drugachenok, I.I.Matveencko, V.P.Mironov. Radiation Doses in Southern Byelorussia from Inhalation of Specific Radionuclides Following the Chernobyl Accident. *Rad. Prot. Dosimetry.* 48(2), 179-183 (1993).
10. A.W.Phipps, G.M.Kendall, J.W.Stather and T.P.Fell. Committed Equivalent Organ Dose and Committed Effective Doses from Intake of Radionuclides. NRPB-R245 (London: HMSO) (1991).
11. NRPB. Revised Generalized Derived Limits of Radioisotopes of Strontium and Curium. (Chilton: NRPB), NRPB-GS8 (1987).
12. K.P.Mahonko, E.G.Kozlova, V.V.Volokitin. Dynamic of Radioactive Iodine Accumulation in Soil and Reconstruction of Doses from its Irradiation at Territory Contaminated after the Accident at Chernobyl NPP. *Radiation and Risk* 7, 140-191 (1996) (in Russian).
13. H.Muller, G.Prohl. ECOSYS-87: A Dynamic Model for Assessing Radiological Consequences of Nuclear Accident. *Health Phys.* 64, 232-252 (1993).
14. V.F.Minenko, S.S.Tretjakevtch, S.V.Trofimik, Y.E.Kruck. Methodical Recommendations for Defining Thyroid Doses for Inhabitants of Settlements of Republic of Belarus. (2001) (Project) (in Russian).
15. M.Y.Orlov, V.P.Snikov, Y.A.Hvalenski, A.A.Volokitin Contamination of the Soil in European Part of Territory of USSR after Accident at the Chernobyl NPP. *Atomic energy* 80, 466-471 1996 (in Russian).
16. V.A.Knatko, I.N.Dorozhok. Reconstruction of ^{131}I Deposition Density in Regions of Belarus with Estimation of Thyroid Doses from Inhalation of Thyroid Doses from Inhalation of ^{131}I . *Radiat. Prot. Dosim.* 93(1), 43-48 (2001).

Radiation Epidemiological Studies in Russian National Medical and Dosimetric Registry: Estimation of Cancer and Non-cancer Consequences Observed among Chernobyl Liquidators

Marat M. MAKSIOUTOV

*Medical Radiological Research Center, Russian Academy of Medical Sciences,
National Radiation and Epidemiology Registry
Koroleva st. 4, Obninsk, 249020, Russia: nrer@obninsk.com*

Abstract

In June 1986 the USSR Ministry of Health Care initiated a large-scale program to establish All-Union Distributed Registry of persons exposed to radiation. The Research Institute of Medical Radiology of Russian Academy of Medical Sciences in Obninsk (currently Medical Radiological Research Center of RAMS) was appointed as the leading organization to create and manage the Registry. Two tasks were set before the Registry: first, assessment of health effects due to the Chernobyl accident with a view to develop an optimal strategy for alleviating the accident consequences for human health and, second, organization of many-years epidemiological studies primarily directed to estimating the actual radiation risks. By 1 December 2001, the Russian National Medical and Dosimetric Registry (RNMDR) included medical and dosimetric data for 585,121 persons exposed to radiation as a result of the Chernobyl accident and residing in the territory of Russian Federation. At present the Registry includes 187,596 liquidators (32.1% of total number of registered).

This article presents comprehensive radiological and epidemiological analysis of individual medical and dosimetric data for the cohort of liquidators available in the RNMDR. Particular emphasis is placed on the issue of estimating radiation risks in induction of cancer and non-cancer diseases. This is due to the fact that the coefficients recommended by ICRP are primarily based on the Japanese epidemiological studies of 1945 atomic bomb survivors of Hiroshima and Nagasaki (the LSS cohort). Statistically significant estimates of radiation risk coefficients for the Japanese cohort, however, were received in the individual dose range above 0.3 Sv. For low doses (up to 0.2 Sv), only extrapolation models without direct epidemiological ascertainment were used. Therefore, the RNMDR is the first to estimate radiation risks for low radiation doses using individual medical and dosimetric information available for the liquidators cohort.

The article consists of five parts. Chapter 1 describes the organizational structure and basic principles of operation of the Russian National Medical and Dosimetric Registry, and provides characterization of the liquidators cohort in the RNMDR. Chapters 2-4 deal with direct radiation-epidemiological studies aimed at estimating and predicting radiation risks using the actual data of the Registry. Radiation risk estimates derived from incidence data on leukemias, solid cancers and noncancer diseases among the liquidators are discussed. The last chapter 5 deals with estimating mortality rate among the Chernobyl liquidators and establishing a possible dose response relationship for mortality. The submitted material is based on scientific papers prepared by the experts of the Registry and published in the famous Russian and international scientific magazines.

1. The short description of the Registry

In 1986 the USSR Ministry of Health Care initiated a program to establish All-Union Distributed Registry (UDR) of persons exposed to radiation due to the Chernobyl accident. The computer center of Research Institute of Medical Radiology of USSR RAMS (Obninsk) became the core of the Registry. The UDR was formed with contributions from all republics of the former Soviet Union, many scientific research

institutions and practical organizations [1]. Information to the UDR was mainly supplied by republican information computer centers of Ministries of Health Care of Belarus, Russian Federation and Ukraine. In 1992 after the disintegration of USSR, on the base of the UDR the Russian National Medical and Dosimetric Registry (RNMDR) was set up in Medical Radiological Research Center of RAMS (former Research Institute of Medical Radiology). The principal objective of the Registry was organization of long-term automated individual recording of persons exposed to radiation effects of the Chernobyl accident, their children and subsequent generations as well as assessment of their vital status.

1.1. Organizational structure and tasks of the Registry

The Registry is a multilevel information system covering all regions of Russian Federation. The Registry provides for four levels: federal, regional, province and district.

In each of the 11 administrative and economic regions of Russia a regional center of the RNMDR was set up to collect individual medical and dosimetric information supplied from districts and provinces and to pass it on to the national level (Fig. 1.1). In addition to regional centers established by the territorial principle, the RNMDR has affiliation centers in Ministry of Defense, Ministry of Internal Affairs, Ministry of Railways, Ministry of Atomic Energy and Federal Security Service. Affiliations with the same status as regional centers were also set up in the regional cities the population of which was worst exposed to radiation as a result of the Chernobyl accident, namely Bryansk, Kaluga, Tula and Oryol.

The Registry is designed to provide information support and to improve the quality and effectiveness of the following:

- clinical examination of the population;
- treatment and health promotion activities;
- studies of the incidence pattern, dynamics and trends of health outcomes in the monitored contingent;
- recommendations on improving prevention, diagnosis and treatment of diseases, conducting protection measures and perfecting the health care system;
- special scientific studies on the health effects of the Chernobyl accident and other radiation disasters and incidents.

The tasks of the Registry include:

- automated recording of passport and registration data for persons exposed to radiation as a result of the Chernobyl accident and other radiation disasters and incidents;
- automated recording and determination of individual radiation doses among the population;
- automated recording of chronic diseases in the monitored cohort before the accident and automated

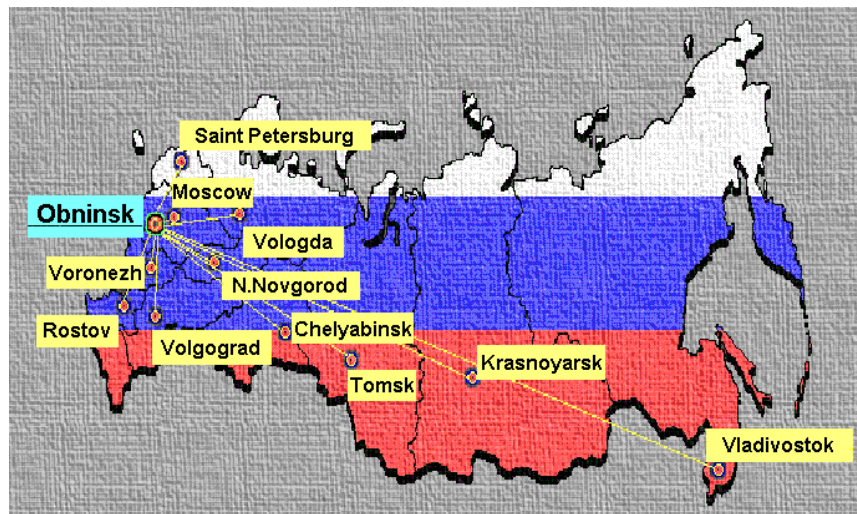

Fig. 1.1. Distribution of regional centers of the Registry across the territory of Russia.

- recording of health status after the accident;
- retrieval of data on request of users;
- quality control for data completeness and medical follow-up.

The users of the Registry are Ministry of Health Care of Russian Federation and Ministry of Emergency of Russian Federation. Other organizations are entitled to get access to materials of the Registry with permission of appropriate health care authorities.

The structure of the Registry was devised with allowance for the experience of similar registries in the world, in particular, the Japanese Registry of atomic bomb survivors in Hiroshima and Nagasaki as well as registries in other countries [2].

1.2. Monitored groups and operational procedures in the Registry

By 1 December 2001, the Registry included medical and dosimetric data for 585,121 persons exposed to radiation as a result of the Chernobyl accident and residing in the territory of Russian Federation. The contingent of the registered persons consists of four groups:

1st group - persons involved in clean up works at the Chernobyl NPP (liquidators). These include:
 - persons who were involved in mitigation of the Chernobyl accident consequences in the exclusion zone in 1986-1990 (including temporary workers and those on a mission), persons dealing with public and cattle evacuation or working at the Chernobyl NPP, military servicemen including air force staff irrespective of where they were stationed and what works involved, and senior and junior militia personnel servicing in the exclusion zone in 1986-1990. These include specialists, servicemen and reservists called up for mitigation works and having a certificate of Chernobyl liquidator of established format. At present the Registry included 187,596 liquidators (32.1% of total registered in the Registry).

2nd group - persons evacuated (among them volunteers) from the exclusion zone in 1986 (areas from which the population was evacuated in 1986 by the radiation safety regulation) including children, among them prenatal at the evacuation time (1.7 %).

3rd group - persons living in the monitored territories (relocation zone) or having lived there immediately after the accident (later moved to another area) (61.1%).

4th group - children born to parents in 1st group involved in mitigation of the accident consequences in 1986-1987 (5.1%).

1.3. Doses for liquidators in the Registry

Let us consider the density $f(D)$ of the distribution of absorbed dose D for liquidators. In what follows, we give a step-by-step approximation to $f(D)$, which by the definition for the dose interval $(D, D+\Delta D)$ is equal to:

$$f(D) = \frac{\Delta N(D)}{\Delta D \cdot N}, \quad (1.1)$$

where: $\Delta N(D)$ is the number of liquidators with a dose between $(D, D+\Delta D)$;
 N is the total number of liquidators in the group analyzed.

We then form groups of liquidators depending on the date of their entry into the contamination zone: 1986; 1987; 1989 and 1990. This classification corresponds to the type of work performed (from the end of May to November 1986: the construction of the sarcophagus) and differs with regard to the radiation situation [3,4].

Fig. 1.2 shows unnormalized histograms of the density of the distribution function $D-\Delta N(D)$ for the above groups. For convenience of comparison, the interval of histograms was taken to be the same for all groups. As can be seen in Fig. 1.2, the distribution of absorbed doses for all liquidators (the group of 119,416 persons with known doses and places of accommodation and work) is rather complex and has peaks at doses

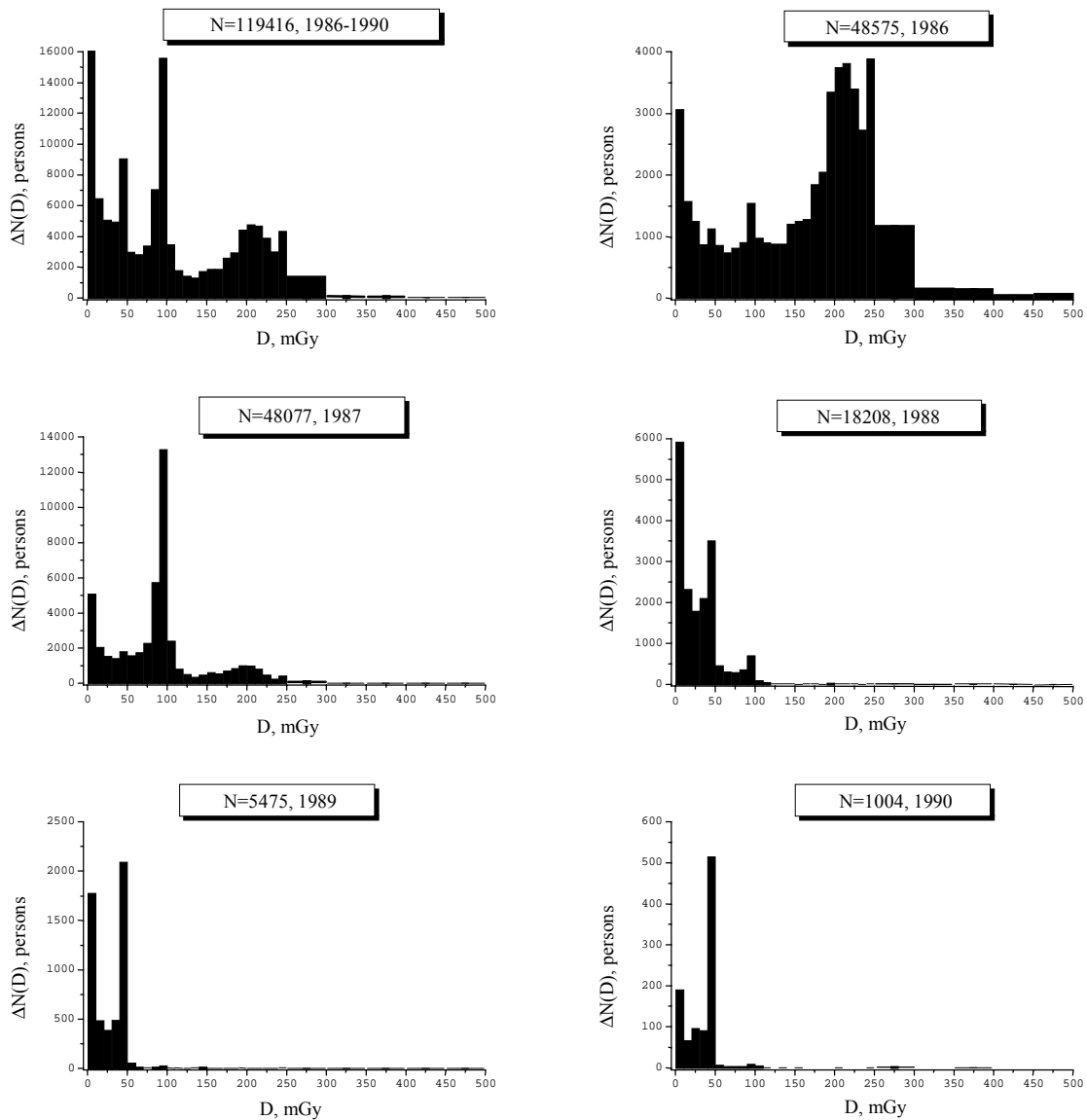

Fig. 1.2. Unnormalized density $\Delta N(D)$ of the distribution of absorbed doses D in liquidators registered in the RNMDR and densities $\Delta N(D)$ for liquidators with different dates of entry into the contaminated areas - 1986, 1987, 1988, 1989, 1990.

of 10, 50, 100 and 200 mGy. At doses higher than 250 mGy the distribution density decreases sharply, which suggests proper management of doses during recovery operations (preventing the excess above the dose limit of 250 mGy for most liquidators) or can be explained by other, possibly, subjective reasons.

For the liquidators of 1986 the dose distribution density has maxima in the range of low doses up to 10 mGy (these doses are most probably attributable to the liquidators who were not involved in Recovery Operations in heavily contaminated areas) and in the range of high doses of 200-250 mGy. For 1987 the indicated maxima are added with a sharp maximum at doses about 100 mGy. This is the dose limit which was established for most of the liquidators in 1987. In the following years, the dose distribution was shifted to even lower values with the maxima at about 10 and 50 mGy.

2. Prediction of long term stochastic effects for liquidators

There are currently two models of radiation risk used for prediction of the temporal trend of radiogenic cancers: the model of relative risk (multiplicative) and the model of absolute risk (additive) [5, 6]. In this

work the multiplicative model is used, since experts of the ICRP consider it to be preferable for most solid cancers.

In a simple multiplicative model for the i -th disease the increment to the cancer mortality rate due to radiation is written as:

$$\Delta\lambda_i(u, t, d) = ERR^i_{ISv}(u, t) \times \lambda_i(u, t) \times f(d),$$

ERR^i_{ISv} is the excess relative risk of mortality for the i -th disease per unit dose [1/Sv];

$f(d)$ is the dose response function (usually linear or linear-quadratic);

$\lambda_i(u, t)$ is the spontaneous mortality rate for the i -th disease in the stratum of the age group, t and the time period, u .

In the additive model:

$$\Delta\lambda_i(u, t, d) = EAR^i_{ISv}(u, t) \times f(d),$$

EAR^i_{ISv} is the excess absolute risk of mortality for the i -th disease [10^4 person-years Sv] $^{-1}$.

Obviously, $ERR^i_{ISv} = EAR^i_{ISv} / \lambda_i$.

In case of rare diseases (for example, leukemia) or diseases with low survival rate and short disease time course, these models can be used to estimate additional incidence rate due to the radiation factor by substitution of mortality rates for incidence rates.

Knowing the distribution of population density for liquidators with time and dose response coefficients, frequency of radiogenic cancers for the i -th disease $\Delta IM_i(t, d)$ (additional mortality due to radiation induced cancers) can be estimated:

$$\Delta IM_i(t, d) = \int_{u_{min}}^{u_{max}} n(u, t) \times \Delta\lambda_i(u, t, d) du,$$

where $n(u, t)$ is the time variations in the size and age structure of the cohort. For calculation of this value one can use survival tables or apply the approach to solve the equation accounting for variations in the population.

Additional mortality rate from all radiogenic cancers is given by

$$\Delta IM(t, d) = \sum_i \Delta IM_i(t, d).$$

For estimation of the contribution of radiogenic cancers to cancer mortality we estimate the value of attributive risk equal to the ratio of the number of radiogenic cancers to the total spontaneous and radiogenic cancers, i.e. to the detected number of cancers.

As exposure of liquidators was protracted in time (the dose rates are lower than in the LSS cohort [7]) we used the dose and dose rate effectiveness factor (DDREF) of 2 for estimating radiogenic cancers. Frequency of radiogenic cancers is calculated with allowance for the latent period (10 years for solid cancers and 2 years for leukemias).

2.1. Calculation models of excess mortality risk for solid cancers and leukemias

In calculation of additional mortality from radiogenic solid cancers and leukemias the approximants of excess relative risk given in [21] were used.

The model used for describing the risk of radiogenic solid cancers has the following form (designations are as in the original):

$$ERR(d, s, e) = \beta_s \times d \times \exp(\gamma \times (e - 30)).$$

Here s is the sex attribute;

d is the dose;

e is the age at exposure;

β_s is the risk coefficient dependent on sex and cancer localization (ERR/Sv). For all solid cancers the coefficient is equal to 0.38;

Table 2.1. Age dependence of parameters β_e and δ_e for leukemias

Age at exposure	0-19	20-39	40+
β_e	-0.553	-0.037	0.708
δ_e	-1.542	-0.688	0.173

Leukemia: In accordance with [21] the model of excess absolute risk of radiogenic leukemias for males is written as:

$$EAR(d, s, e, t) = (d + \theta \times d^2) \times \exp(\beta_e + \delta_e \times \log(t / 25)).$$

The parameters β_e and δ_e dependent on age at exposure account for the level and temporal trend of risk for leukemias, respectively. The values of these parameters as a function of age at exposure are given in Table 2.1. The value of θ is taken to be 1.53.

2.2. Prediction of mortality from radiogenic cancers in the liquidators

Leukemia

Effects of exposure to ionizing radiation are characterized by the increase of the leukemia incidence rate because, according to current concepts, radiation risks of leukemia are much higher than those for solid cancers. The time elapsed since the accident is now sufficient for leukemia induction (the latent period is about 2 years). A prediction of expected mortality from radiogenic leukemias in the Chernobyl liquidators is presented in Fig. 2.1. The expected life-time number of radiogenic leukemias is 32 cases (per 100,000 persons with the mean dose 0.11 Sv).

The attributive risk of radiogenic leukemias changes significantly with time since the accident. The peak in the attributive risk of 41% is expected 5 years after the accident. Such dependence of the attributive risk is due to a similar time dependence of the excess relative risk. This means that today the peak in induction of radiogenic leukemias has passed. The attributive risk is currently 35%, i.e. each third leukemia in the cohort of liquidators is radiation induced. Even 50 years after the accident the attributive risk of leukemias will exceed the risk for solid cancers and be equal to 10%.

Solid cancers

Fig. 2.2 shows occurrence of solid radiogenic cancers in the cohort of liquidators as a function of time since the accident (per 100,000 persons), the mean dose is 0.11 Sv (mean dose for liquidators). The expected life-time number of radiogenic solid cancers is 320 cases (per 100,000 persons). The peak in the incidence rate is expected to occur 30-35 years after the accident and will approximately be equal to 10 cases per year.

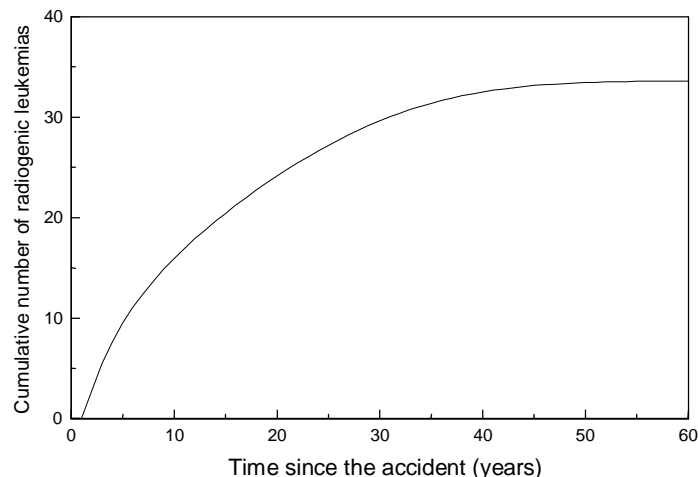

Fig. 2.1. Temporal pattern of radiogenic leukemias in the cohort of liquidators (per 100,000 persons).

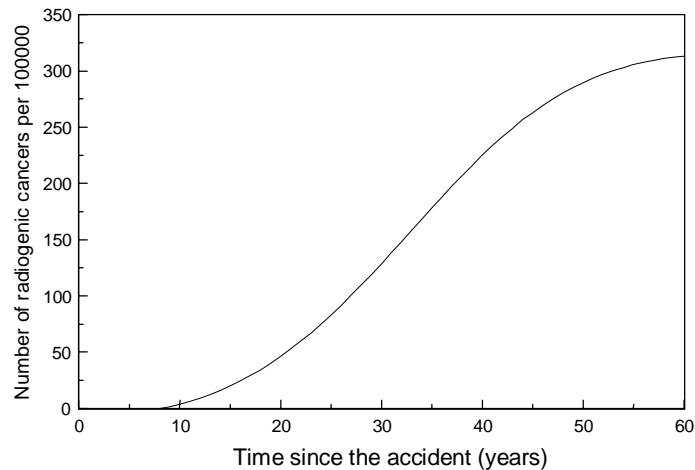

Fig. 2.2. Temporal pattern of radiogenic solid cancers in the liquidators. (per 100,000 persons).

Table 2.2. Temporal pattern of the attributive risk of radiogenic cancers (%).

Malignant neoplasms	Time since the accident (years)			
	5	10	20	50
Solid cancers	-	1.5	1.6	2.4
Leukemias	40.5	34.4	23.3	10.1
Digestive system diseases	-	1.5	1.7	2.3
Respiratory system diseases	-	8.4	3.3	0.9

The attributive risk increases with time and reaches 2.4% 50 years after the accident. The growth of the attributive risk with time is due to a greater contribution from liquidators exposed at younger age because the radiation risk of solid cancers increases as the age at exposure decreases.

Table 2.2 contains the values of the attributive risks for solid cancers, leukemia and malignant neoplasms for the digestive and respiratory systems.

The presented results of predicting the excess cancer mortality due to radiation in liquidators are preliminary. As was indicated, the estimates are rather approximate because of uncertainties in parameters used in predictions. This is, first of all, the uncertainty in the risk coefficients which were obtained for different exposure conditions (doses and dose rates) and for other populations. All this lets us assume that the projection based on the models currently accepted in the world radiation epidemiology and discussed in this chapter may be underestimation. As a consequence, the expected stochastic effects can, in fact, be more pronounced. Optimization of measures to minimize health effects of the Chernobyl accident becomes of even more social significance. Solutions to these problems can be sought in many-years radiation-epidemiological studies in the RNMDR system based on the Chernobyl data.

3. Trends of cancer incidence among liquidators: estimation of radiation risks

One of the issues related to radiation effects on liquidators that has not been adequately covered in the literature is how frequency of malignant diseases can be modified by risk factors. At the same time, malignant neoplasms are known to be radiogenic [8], as confirmed by both clinical and radiation-epidemiological studies [5].

The long-term study of the 1945 atomic bomb survivors in Hiroshima and Nagasaki has revealed an increase in risk of malignant diseases and corresponding mortality with increase in radiation dose [2].

This chapter deals with calculating cancer incidence rates and assessing radiation risks for the liquidators in the period from 1986 to 1997-1998. The analysis is based on the data available in the RNMDR about radiation risks of leukemia (ICD-9: 204-208) and solid tumors (ICD-9: 140-165, 170-195). The

incidence of leukemia and solid tumors was analyzed using the cohort methodologies [9,10]. Particular attention was attached to deriving a relationship between incidence rates and different risk factors. The incidence rates are primarily dependent on age of liquidators, external radiation dose and time of entry into the zone. The absolute values of incidence rates tend to increase with time since the Chernobyl accident.

3.1. Analytical method for radiation risk assessment

In cohort epidemiological studies long-term systematic surveillance of a group of persons is carried out to collect individual information on their health status.

For each person the time at risk to develop a disease of a particular class is calculated as a difference of dates T_1 and T_0 , where T_0 is time of arrival to the 30-km zone and T_1 is one of the following dates: the date of the first diagnosis for the class of diseases under study, the date of the latest medical examination or the date of death. The incidence rate used in this study is defined as a ratio of the total cases to the total times at risk measured in person-years.

At first, in order to estimate the difference in cancer incidence between liquidators and the population of Russia as a whole, Standardized incidence ratio (SIR) is calculated. Age-specific incidence rates for the male population of Russia were used in SIR calculations.

Secondly, to derive the dependence of incidence rates on dose, the individual data about liquidators have been grouped in a multidimensional table. In the present study the data are grouped into 10 strata by age ([18-20), [20-25), [25-30), [30-35), [35-40), [40-45), [45-50), [50-55), [55-60), [60+) years), into 6 groups according to dose ([0-50), [50-100), [100-150), [150-200), [200-250), [250+) mGy) and groups by calendar year (from 1986 to last year of surveillance).

Let i be the index of age-time group and j be the index of dose group.

Let Y_{ij} be the number of cases, P_{ij} is person-years and M_{ij} is the incidence rate in stratum ij . In these terms M_{ij} for a given class of diseases can be defined as:

$$M_{ij} = Y_{ij} / P_{ij}. \quad (3.1)$$

It is reasonable to assume [11,12] that Y_{ij} values are independent Poisson random variables with mathematical expectation $E(Y_{ij}) = P_{ij}M_{ij}$. To determine the dose dependence of M_{ij} it is necessary to present M_{ij} in the form of parametric function and determine its parameters using the maximization of likelihood function:

$$l = \sum \{Y_{ij} \ln(P_{ij}M_{ij}) - P_{ij}M_{ij}\}, \quad (3.2)$$

where $M_{ij} = f(D_{ij})$ where D_{ij} is the average dose in stratum ij .

Simple functions are used in this work:

$$f(D_{ij}) = M_{i0} \exp(ad_{ij}), \quad (3.3)$$

$d_{ij} = 0$ for $j = 0$ and $d_{ij} = 1$ for $j > 0$.

$$f(D_{ij}) = M_{i0} (1 + bD_{ij}). \quad (3.4)$$

$$f(D_{ij}) = M_{i0} + yD_{ij}. \quad (3.5)$$

Equation (3.3) is used to determine the relative risk $RR = \exp(a)$, and equation (3.4) is used to determine the significance of dependence of relative risk on dose. The statistical test applied for these purposes is the test of ratios of likelihood maxima at null hypothesis $b=0$. The 0-50 mGy group is used as baseline dose group ($j=0$, internal control).

Estimation of parameters of equations (3.3-3.4), statistical tests and determination of confidence intervals are performed on the software AMFIT [12].

For calculation of the dose dependence of leukemia incidence rates, equation (3.5) was used with stratification solely by age.

3.2. Results of radiation risk assessment

Leukemia

The cohorts of liquidators in this study total 99,024 people [13]. All worked within the 30-km zone.

Members of the cohort reside in the European part of Russia. In 1986, 44,057 individuals served, and their mean dose from external penetrating radiation was 0.168 Gy. In 1987, 35,689 people served; their mean dose was 0.093 Gy. For the three-year period 1988-1990 inclusive, additional 19,278 persons, with a mean dose of 0.033 Gy, from the Russian Federation were involved in recovery operations related to the Chernobyl accident.

The incidence of leukemia in these liquidators has been followed up to the end of 1997. Standardized incidence ratios (SIR) together with related information are provided in Table 3.1 for all leukemia, chronic lymphocytic leukemia, and chronic myeloid leukemia in the liquidators. The results have been tabulated separately for the early period (April 1986-1990), the later period (1991-1997) and for the entire period of follow-up. The SIR values are relative to the comparable age-, sex- and period-specific rates for the Russian Federation as a whole.

The SIR for all leukaemia was elevated for both periods, but slightly more for 1991-1997. The question is to what extent these elevated values may reflect the effect of differential case ascertainment for the liquidators compared to that for the general population of Russia. Table 3.1 provides the standardized incidence ratios for chronic lymphocytic leukemia (deemed a subtype not increased by radiation exposure) and chronic myeloid leukemia (a subtype for which incidence can be increased by radiation exposure) for these same periods. The elevated standardized incidence ratio for chronic lymphocytic leukemia indicates that a substantial effect of screening exists. However, the standardized incidence ratio for chronic myeloid leukemia is some two-fold higher than that for chronic lymphocytic leukemia in the same 1991-1997 period,

Table 3.1 Standardized incidence ratio for various types of leukemia in Russian liquidators.

Period	Person-years	Number of cases		Standardized incidence ratio ^a (SIR)
		Observed	Expected	
Leukaemia (ICD-9: 204-208)				
1986-1990	398 630	17	8.6	1.98 (1.15-3.17)
1991-1997	613 203	48	17.7	2.71 (2.00-3.59)
1986-1997	1 011 833	65	26.3	2.47 (1.91-3.15)
Chronic lymphocytic leukaemia (ICD-9: 204.1)				
1986-1990	398 630	4	1.7	2.33 (0.62-5.96)
1991-1997	613 203	14	4.5	3.10 (1.70-5.20)
1986-1997	1 011 833	18	6.2	2.89 (1.71-4.56)
Chronic myelogenous leukaemia (ICD-9: 205.1)				
1986-1990	398 630	4	1.3	3.01 (0.81-7.72)
1991-1997	613 203	21	2.7	7.76 (4.81-11.9)
1986-1997	1 011 833	25	4.0	6.20 (4.01-9.16)

^a 95% CI in parentheses.

Table 3.2. Standardized incidence ratio and excess relative risk for leukemia among Russian liquidators with documented individual doses.

Period	Person-years	Number of cases		Standardized incidence ratio ^a (SIR)	Excess relative risk ^a (Gy) ⁻¹
		Observed	Expected		
Leukaemia (ICD-9: 204-208)					
1986-1990	288 917	16	6.1	2.63 (1.15-4.28)	n.a.
1991-1997	454 867	36	12.6	2.85 (1.99-3.94)	0.83 (-1.62-3.31)
1986-1997	743 784	52	18.7	2.78 (2.07-3.64)	1.16 (-1.17-3.52)
Leukaemia excluding chronic lymphocytic leukaemia (ICD-9: 204-208 excluding 204.1)					
1986-1990	288 917	13	4.9	2.55 (1.41-4.54)	n.a.
1991-1997	454 867	27	9.5	2.84 (1.88-4.14)	2.93 (-0.83-6.72)
1986-1997	743 784	40	14.4	2.78 (1.99-3.79)	4.58 (0.51-8.60)

^a 95% CI in parentheses.

Table 3.3. Incidence of solid cancers among Russian liquidators.

Period	Person-years of follow-up	Number of cases		Standardized incidence ratio (SIR) ^a
		Observed	Expected	
Nuclear workers				
1991-1998	107 133	278	293	0.95 (0.84-1.07)
Previously not nuclear workers				
1991-1998	704 375	1 152	1 259	0.91 (0.86-0.97)

^a 95% CI in parentheses.

Table 3.4. Standardized incidence ratio and excess relative risk of solid cancers among Russian liquidators with documented individual doses in the range of 0.001-0.3 Gy.

Period	Person-years of follow-up	Number of cases		Standardized incidence ratio ^a (SIR)	Excess relative risk ^a (Gy) ⁻¹
		Observed	Expected		
Nuclear workers					
1991-1998	56 356	149	146	1.01 (0.86-1.20)	0.56 (-1.23-2.79)
Previously not nuclear workers					
1991-1998	514 101	847	898	0.94 (0.88-1.01)	0.82 (0.28-1.37)

^a 95% CI in parentheses.

suggesting the possibility of radiation-related excesses.

The question whether radiation exposure from their work in the 30-km zone may have led to excess leukemia was addressed by examining the excess relative risk (ERR) per Gy in the liquidators for whom individual measurements of external dose were available. With this criterion, the number of person-years of follow-up (Table 3.2) is about three-quarters of the total in Table 3.1. The SIR for all leukemia is given in Table 3.2 for this group with documented individual doses; 2.85 (95% CI: 1.99-3.94) for the period 1991-1997, which is essentially identical to the value of 2.71 (95% CI: 2.00-3.59) in Table 3.1 for the entire cohort. The ERR per Gy for all leukaemias was not significantly associated with radiation dose. For the forms of radiogenic leukemia (all leukemia excluding chronic lymphocytic leukemia), however, a significant association with dose is observed over the entire period of follow-up (1986-1997). For the period 1991-1997, however, ERR per Gy is elevated but not significantly so.

Solid cancers

For investigation of solid cancers, Russian liquidators were divided into two different groups. The first group comprised 16,280 persons who had been nuclear workers before the accident occurred. The second group is larger (comprising 96,982 persons) and consists of those who had not been nuclear workers prior to their participation in recovery operations within the 30-km zone.

A five-year latency period was employed for the analysis of solid cancers. The SIR values for solid cancer appearing 1991-1998 are provided in Table 3.3 for the two groups of the liquidators. The control is the age-and sex-standardized rates for the whole of Russia. SIR were <1 for both groups, while for those who had not previously been nuclear workers SIR was significantly low, indicating a significant healthy worker effect.

The correlation of solid cancer incidence with dose was examined for those workers who had documented individual doses (the range 0.001-0.3 Gy was selected). This selection decreased the person-years of follow-up by about 50% for those who had been nuclear workers (comparing Table 3.3 with Table 3.4) and by about 30% for those who had not previously been nuclear workers. The SIRs for those with documented individual doses, however, were similar to those shown for the entire group. While the point estimates of ERR were greater than zero for both groups (Table 3.4), the ERR was significant only for those who had not been nuclear workers prior to their participation in recovery operations (0.82 (0.28-1.37)). The ERR was not significant in the case of those who had been nuclear workers previously (0.56 (-1.23-2.79)).

Some words about risk assessment for other solid cancer sites. Table 3.5 contains estimates of radiation

Table 3.5. Excess relative risk for malignant neoplasm of the digestive and respiratory systems.

Disease class	ICD-9 code	ERR/Gy	Significance level
Malignant neoplasm of the digestive system	150-159.9	0.85 (-0.3,2.04)	0.2
Malignant neoplasm of the respiratory system	160-165.9	1.13 (-0.24,2.4)	0.14

risks for malignant neoplasm of the digestive and respiratory systems. For both types of the solid tumors were detected non-statistically significant excesses in the incidence of malignant neoplasm.

The estimates of radiation risks for solid cancers in the previous studies of cancer incidence in liquidators [14] are consistent, within statistical errors, with the results of the present study. In our present study the ERR per Gy for solid cancers is estimated to be 0.82 (0.28-1.37), which is somewhat higher than the values previously presented [15,16]. It should be pointed out, however, that the sex and age patterns of these cohorts are different, as well are the systems of health care, methods of data collection, estimation of radiation doses etc. In order to assess the influences of all these factors, detailed long-term studies are required. Further study of the Chernobyl liquidators will serve to reduce uncertainties in interpretation of the effects of radiation on human health.

4. Radiation-epidemiological analysis of incidence of non-cancer diseases in liquidators.

Most of studies of health consequences of the Chernobyl accident and related radiation risks are concerned with dose response relationship of cancer incidence and mortality. But in the last few years a possible relationship between radiation exposure and frequency of non-cancer diseases is being discussed in scientific publications in Russia and abroad. Therefore it becomes particularly important to estimate radiation risks of non-cancer diseases from low doses within the study of the health status of liquidators. This chapter presents results of radiation-epidemiological studies of the cohort of liquidators registered in the RNMDR. This chapter discusses the dose response relationship for non-cancer incidence [17].

For this epidemiological analysis we formed a retrospective cohort consisting of 68,309 male liquidators, for each of which external gamma radiation dose was known and health information was available in the RNMDR (at least one entry from 1986 to 1996) and all were registered before 1.01.1992. For radiation risk assessment the analytical method described in chapter 3.1 was used. The 0-50 mGy group was taken as the baseline group (internal control).

4.1. Results of radiation risk assessment

All non-cancer classes

This section provides estimates of the excess relative risks (ERR) for main classes of non-cancer diseases derived from the cohort of liquidators.

As can be seen from Table 4.1, the statistically significant dose dependency with 95% confidence interval was derived for four classes of non-cancer diseases [18]:

1. endocrine diseases and metabolic disorders (ERR=0.58 with 95% CI (0.30; 0.87));
2. mental disorders (ERR=0.40 with 95% CI (0.17; 0.63));
3. diseases of the nervous system and sensory organs (ERR=0.35 with 95% CI (0.19; 0.52));
4. diseases of the digestive system (ERR=0.24 with 95% CI (0.05; 0.43)).

Two other classes of diseases have been estimated to be close to their statistical significance. These classes are:

1. diseases of the circulatory system (ERR=0.23 with 95% CI (-0.03; 0.50));
2. diseases of the genitourinary system (ERR=0.43 with 95% CI (-0.02; 0.87)).

For other classes of diseases under study no statistically significant dose dependencies were observed. We also calculated ERR for liquidators separately with different time of arrival to the emergency zone. It is only the endocrine

Table 4.1. Estimation of parameters of dose dependency of incidence rates for different non-cancer diseases among liquidators.

Disease	ICD-9 codes	P	ERR (1/Gy)
Infectious and parasitic diseases	001-139	0.152	-0.49 (-1.12; 0.15)
Endocrine and metabolic diseases	240-279	<0.001	0.58 (0.30; 0.87)
Diseases of blood and blood-forming organs	280-289	0.701	-0.17 (-1.00; 0.67)
Mental disorders	290-319	<0.001	0.40 (0.17; 0.64)
Diseases of the nervous system and sensory organs	320-389	<0.001	0.35 (0.19; 0.52)
Diseases of the circulatory system	390-459	0.077	0.23 (-0.03; 0.50)
Diseases of the respiratory system	460-519	0.893	0.11 (-0.15; 0.18)
Diseases of the digestive system	520-579	0.013	0.24 (0.05; 0.43)
Diseases of the genitourinary system	580-629	0.048	0.43 (-0.02; 0.87)
Diseases of the skin and subcutaneous tissue	680-709	0.377	-0.22 (-0.70; 0.26)
Diseases of the musculoskeletal system and connective tissue	710-739	0.319	0.09 (-0.09; 0.26)
Injuries and poisoning	800-999	0.161	0.24 (-0.11; 0.59)

and metabolic diseases for which statistically significant estimates of ERR were obtained for both 1986 and 1987. The values of ERR for the liquidators of 1986 was 0.57 with 95% CI (0.19; 1.00) and for the liquidators of 1987 the value of ERR was 0.75 with 95% CI (0.28; 1.22). Below listed are diseases for which statistically significant estimates of ERR were obtained when the group was separated according to the year of arrival to the zone:

- mental disorders, 1986 (ERR=0.53 with 95% CI (0.21, 0.85));
- diseases of the nervous system and sensory organs, 1986 (ERR=0.45 with 95% CI (0.22; 0.68));
- diseases of the digestive system, 1986 (ERR=0.27 with 95% CI (0.01, 0.52));
- diseases of the genitourinary system, 1987 (ERR=0.89 with 95% CI (0.10, 1.68)).

Thus, as a result of the radiation-epidemiological analysis of the dose dependency of non-cancer diseases a series of classes of diseases were identified which show a statistically significant growth with increase in dose. For diseases of the genitourinary system, the statistically significant relative risk was obtained only for the liquidators of 1987, whereas for all liquidators the estimate of relative risk is not statistically significant.

Cardiovascular diseases

Table 4.2 gives calculated radiation risks of the diseases of the circulatory system among liquidators. The conducted studies have revealed, first of all, a statistically significant estimate of ERR for cerebrovascular diseases (ERR=1.17 with 95% CI (0.45; 1.88) and essential hypertension (ERR=0.52 with 95% CI (0.07; 0.98)). It has also been demonstrated that for the liquidators who arrived to the zone in 1986 the value of ERR for cerebrovascular diseases was higher than for the cohort as a whole and equals 1.29 (95% CI (0.34; 2.24)) and for essential hypertension among the liquidators of 1987 the value ERR is 0.88 with 95% CI (0.10; 1.66).

Among diseases of the circulatory system attention should be paid to the class as a whole, in which the value ERR is 0.23 with 95% CI (-0.03; 0.50), and hypertension (ERR=0.35 with 95% CI (-0.05; 0.74)). The lower boundary of these two diseases is almost 0, i.e. there is a clear tendency, even though not statistically

Table 4.2. Estimated parameters of the dose dependency of incidence of diseases of the circulatory system among liquidators.

Disease	ICD-9 codes	P	ERR(1/Gy)
Diseases of the circulatory system	390-459	0.077	0.23 (-0.03; 0.50)
Hypertensive disease	401-405	0.071	0.35 (-0.05; 0.74)
essential hypertension	401	0.016	0.52 (0.07; 0.98)
hypertension with heart affection	402	0.814	-0.08 (-0.76; 0.60)
Ischaemic heart disease (IHD)	410-414	0.735	0.08 (-0.39; 0.55)
acute myocardial infarction	410	0.702	0.29 (-1.23; 1.81)
other acute IHD	411	0.642	-0.35 (-1.74; 1.05)
angina pectoris	413	0.372	0.31 (-0.40; 1.01)
other chronic forms of IHD	414	0.970	-0.04 (-0.64; 0.57)
Other heart diseases	420-429	0.927	-0.04 (-0.83; 0.90)
Cerebrovascular diseases	430-438	<0.001	1.17 (0.45; 1.88)
Diseases of arteries, arterioles and capillaries	440-448	0.167	0.56 (-0.31; 1.44)
Diseases of veins, lymphatic vessels and other diseases of the circulatory system	451-459	0.341	-0.25 (-0.75; 0.26)

significant.

We also studied robustness of radiation risk estimates depending on dose group ranges and effect of stratification by the arrival year on these estimates. The study has shown that division into smaller dose groups does not result in noticeable differences in radiation risk estimates.

It should be noted that the study did not allow for recognized risk factors such as excessive weight, hypercholesterolemia, smoking and alcoholism. Therefore, there is no way thus far to single out the radiation component in incidence of diseases of the circulatory system and other somatic diseases among liquidators. This requires in-depth studies considering all risk factors of both radiation and non-radiation nature and conducting detailed questioning of liquidators under study.

5. Mortality among the liquidators: estimation of radiation risks

This part of the article is based on the paper [19] and deals with estimating mortality rate among the Chernobyl liquidators and establishing a possible dose response relationship for mortality (radiation risks). The importance of these issues is associated with two aspects: first, from the epidemiological standpoint it is vital to study a possible dose response of mortality rate, considering low doses in the cohort under study (the mean external gamma radiation dose to liquidators is 0.1 Sv), and secondly, because mortality and its dynamics is a reflection of social, economic and political conditions in the country.

The size of the cohort of liquidators (65,905 persons) considered in the present paper is comparable to that of the above mentioned cohorts and these data may be of interest as an additional source of information about relationship of low radiation doses (<0.3 Sv) and mortality.

In the present work, the term dose implies a documented external radiation dose for a specific liquidator. In order to reduce the uncertainty in the marginal dose intervals, the analysis of dose response was based on data on liquidators with the doses from 5 to 300 mSv. A total of 65,905 liquidators with a

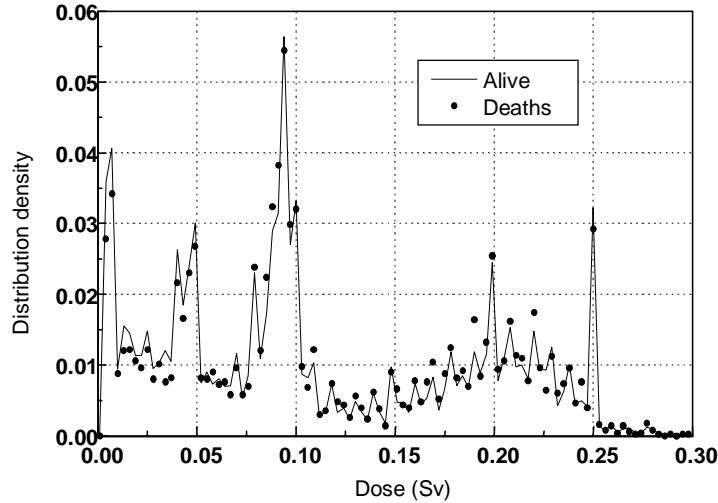

Fig. 5.1. Distribution of the alive liquidators and deaths by external radiation dose.

documented dose falling in this dose interval (follow up 1991-1998) were entered in the cohort under study. The number of follow-up person-years in 1991-1998 in this cohort was 426,304.

Distribution of liquidators by external dose is shown in Fig. 5.1. It is seen from Fig. 5.1 that the distribution has four pronounced peaks. The peaks of 0.05, 0.10 and 0.25 Sv are dose limits established administratively. The limit of 0.25 Sv was set for liquidators working in the zone in 1986, 0.1 Sv - for liquidators of 1987 and 0.05 Sv - for the remainder.

The analysis included 4,995 deaths with documented cause of death and doses in the selected dose interval 5-300 mSv.

Basically, four classes of causes of death were considered as based on the International Classification of Diseases (ICD) [18]:

- malignant neoplasms: code of ICD-9 140-239.9;
- cardiovascular diseases: code of ICD-9 390-459.9;
- injuries and poisoning: code of ICD-9 800-E 999;

Table 5.1. Mean dose characteristics for death cases as a function of working time in the zone (the range 5-300 mSv).

Year of working time	Population	Mean dose (mSv) ^a	Mean length of stay (days) ^a	Mean dose rate (mSv day ⁻¹) ^a
1986	1978	171	68.2	2.9
1987	2169	97	74.2	1.4
1988	636	37	74.5	0.4
1989	206	40	108.5	0.5
1990	16	43	30.0	0.5
1986-1990	4995	116	72.4	1.8

^a Person-year weighted averages.

Table 5.2. Number of deaths and SMR with 95% confidence intervals for main mortality classes.

Parameter	Malignant neoplasms	Noncancer causes of death			Total	All causes
		Cardiovascular diseases	Injuries and poisoning	Other		
Number of deaths	515	1728	1858	894	4480	4995
SMR (95%CI)	0.87 (0.80, 0.95)	1.07 (1.03, 1.13)	0.78 (0.74, 0.81)	0.82 (0.77, 0.88)	0.85 (0.83, 0.88)	0.85 (0.82, 0.87)

- diseases other than the above: code of ICD-9 0-139.9, 240-389.9 and 460-799.9.

Subclasses were not considered because of the short observational period and limited number of deaths.

The main dosimetric characteristics for cases of death are shown in Table 5.1.

The number of deaths included in the analysis of the mortality pattern is shown in Table 5.2.

For analysis of mortality rates and estimation of risk coefficients (using the external control), the general spontaneous mortality rate in Russia in 1991-1998 obtained from official statistics sources was used.

5.1. Analytical method for radiation risk assessment

The performed descriptive analysis of mortality is based on using the standardized mortality ratio (SMR). The expected number of deaths is calculated using the dynamics of person-years in the cohort and the age-specific mortality rate (males) for the population of Russia in the period from 1991 to 1998. The confidence intervals for SMR were calculated using the approach proposed in [11]. The projection of the mortality pattern is based on estimates of expected number of deaths.

Risk coefficients were estimated by the method of maximum likelihood, assuming that the numbers of deaths are the non-stationary Poisson series of events. We considered the non-stationary process to allow for changes in the spontaneous mortality in the considered time period.

The significance tests were derived from asymptotic properties of the likelihood ratios. The analysis is based on individual information about external radiation dose, number of observational person-years and age at exposure time.

The risk estimates were made using both the external (spontaneous mortality in Russia as a whole) and the internal control group. The logarithm of the likelihood function L for the given sample is [20]:

$$\ln L(f, ERR_{ISv}) = \sum_{i=1}^n (\ln(\lambda_{i,fp_i})) - \sum_{k=0}^{fp_i} \lambda_{i,k} - \sum_{j=1}^N \sum_{k=0}^{fp_j} \lambda_{j,k}. \quad (5.1)$$

Risk coefficients were estimated using the linear model.

Model for the external control

In calculations using the external control group the risk model takes the form:

$$\lambda_{i,k} = \lambda_{i,k}^o \cdot f \cdot (1 + ERR_{ISv} \cdot d_i). \quad (5.2)$$

Where $\lambda_{i,k}$ is the intensity of the events series (here the mortality) for person i at the k -th time interval; fp_i is the period of follow-up for the cohort member i (the time lapse from the start of follow up to the date of death or the period of the follow-up for an alive member of the cohort);

n is the number of deaths in the observational period;

N is the number of alive members of the cohort included in the analysis;

$\lambda_{i,k}^o$ is the spontaneous mortality rate in Russia corresponding to the attained age of the i -th cohort member at the k -th time interval;

d_i is the external radiation dose for the i -th cohort member;

ERR_{ISv} is the excess relative risk per unit dose (sought parameter);

f is the coefficient (sought parameter) accounting for the difference between the spontaneous mortality in the liquidators cohort and the general population of respective age in the time period considered. In the used model this coefficient is equal to the SMR for unexposed members of the cohort. The variation of the coefficient f from unity may be explained by completeness and reliability of mortality data in the Registry or a possible «healthy workers effect», as the liquidators were subject to additional medical checks before going to work in the zone. The selected risk model has the advantage that it estimates both the dose response and the difference in spontaneous mortality in the followed up cohort and the referent Russian population.

The spontaneous mortality rate for each person was equal to the corresponding national rate for the attained age at a given time moment. We believe that individual information is preferable for risk estimation

because it makes possible to minimize the influence of subjective factor and loss of information in data grouping and stratification.

Thus, it is only the relative age distribution of spontaneous mortality rates that is used for risk estimation and this is a more robust characteristic than the absolute distribution. The value of f was assumed to be the same for all age groups.

The 95% likelihood intervals were determined from the likelihood function profile.

Model for the internal control

When risk coefficients were estimated using the internal control, data were stratified by attained age and calendar time, and the spontaneous mortality was determined from the balance of the observed and expected number of cases in a given stratum.

The risk model is written as:

$$\lambda_{i,k} = \lambda_{i,k}^{EW} \cdot (1 + ERR_{ISv} \cdot d_i) \tag{5.3}$$

Where:

$\lambda_{i,k}^{EW}$ -is the spontaneous mortality rate among liquidators in the stratum by the attained age and calendar time in which the i -th person under study falls.

The spontaneous mortality in the stratum by attained age j , at time moment k was taken to be as follows:

$$\lambda_{j,k}^{EW} = \frac{n_{j,k}}{\sum_{i \subset j} PY_{i,k} \cdot (1 + ERR_{ISv} \cdot d_i)} \tag{5.4}$$

5.2.Results

Fig. 5.2 shows the SMR dynamics from all causes in the studied cohort of 65,905 individuals.

The mortality from all causes is lower than the general Russian rate and is basically a reflection of the corresponding pattern in Russia as a whole in the considered period. It should be pointed out, however, that the mortality rate in the cohort of liquidators is gradually approaching the general Russian one. In 1998 the mortality from all causes was about 8 deaths per 1,000 persons.

Table 5.3 shows that for the considered dose interval (5-300 mSv) the spontaneous mortality of liquidators is lower than the general Russian one and equals about 82% of the general all-Russian mortality for the population of corresponding age. The observed difference in the spontaneous mortality (the coefficient $f=0.82$) can be either because of incomplete data on mortality in the general population or due to the «healthy workers effect» in the liquidators.

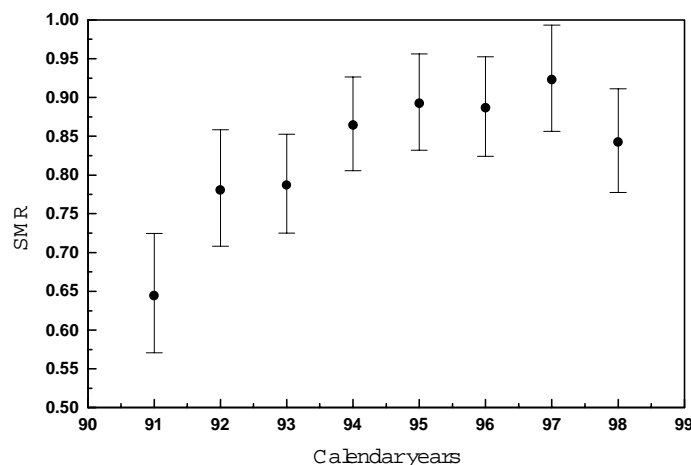

Fig. 5.2. SMR dynamics from all causes.

Table 5.3. Estimates of risk coefficients for deaths among liquidators.

Parameter	Cancer: ICD-9 140-208	Non cancer				All causes
		Non cancer: Other than ICD-9 140-208	Injuries and poisoning: ICD-9 800-E999	Cardiovascular diseases: ICD-9 390-459.9	Other than in columns 3 and 4: ICD-9 0-139.9, 240-389.9, 460-799.9	
Number of cases	515	4480	1858	1728	894	4995
Risk coefficients derived using the external control (spontaneous mortality in Russia)						
ERR S_v^{-1}	2.11 (1.31, 2.92)	0.13 (-0.09, 0.35)	-0.36 (-0.68, -0.04)	0.54 (0.18, 0.91)	0.23 (-0.26, 0.73)	0.27 (0.06, 0.48)
Coefficient f	0.70 (0.64, 0.76)	0.84 (0.81, 0.87)	0.81 (0.77, 0.85)	1.01 (0.97, 1.06)	0.80 (0.75, 0.85)	0.82 (0.80, 0.85)
Risk coefficients calculated using the internal control (spontaneous mortality derived from the balance of the observed and expected mortality in the strata at attained age and calendar time. In parentheses are 95% likelihood intervals						
ERR S_v^{-1}	2.04 (0.45, 4.31)	0.15 (-0.24, 0.60)	-0.36 (-0.89, 0.26)	0.79 (0.07, 1.64)	0.18 (-0.67, 1.26)	0.31 (-0.08, 0.74)

The mortality pattern for the considered causes of death is shown in Fig. 5.3. The observed pattern is in good agreement with the expected.

The proportion of deaths from malignant neoplasms and other causes (except the circulatory system diseases and injuries and poisoning) remains nearly constant at 10 and 20%, respectively, which is consistent with the prognosis. The percentage of the deaths due to cardiovascular diseases grows, while deaths from injuries and poisoning decrease. It is worth noting that the fraction of mortality from injuries and poisoning among liquidators in 1986-1992 was significantly higher than in the same age group in the country as a whole.

The mortality from cardiovascular diseases becomes predominant (about 42% in 1998) and corresponds to changes in the general mortality pattern for a given age group in Russia.

The SMR dynamics for cancer in Fig. 5.4 show a little lower mortality than the control (all-Russian). In 1998 the mortality rate from this cause was 110 deaths per 100,000 persons. Dynamics of SMR from cardiovascular diseases is shown in Fig. 5.5

With respect to all causes of death as a whole and separate categories, the mortality pattern in the considered cohort reflects the general trends in Russia. The mortality among liquidators is lower than in the

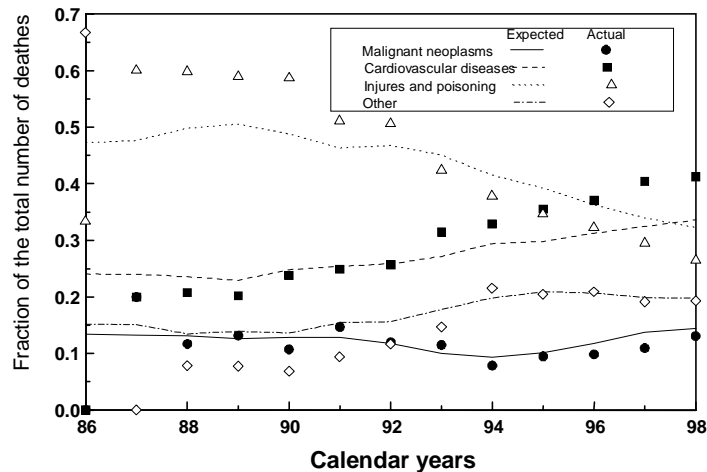

Fig. 5.3. Pattern of overall mortality by disease categories for liquidators.

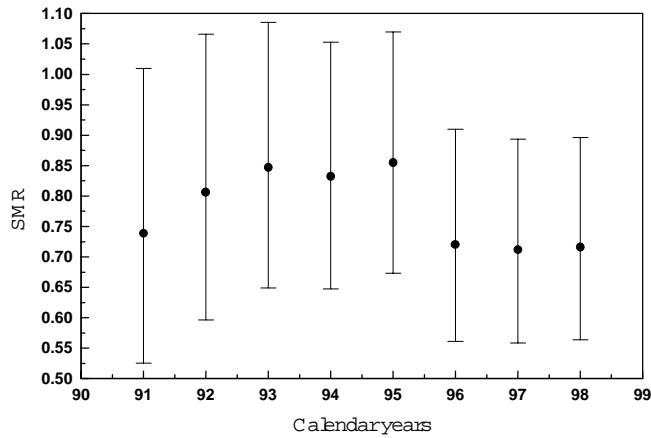

Fig. 5.4. SMR dynamics from malignant neoplasms.

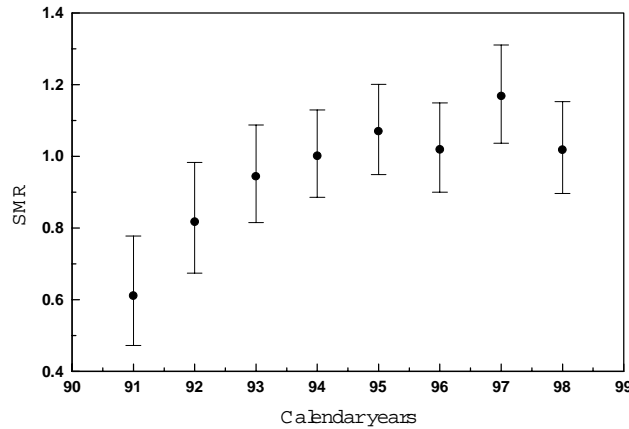

Fig. 5.5. Dynamics of SMR from noncancer diseases in liquidators (cardiovascular diseases).

corresponding age group in the country. An exception is the mortality from cardiovascular diseases for which the mortality became the same level as all-Russian by the end of the follow-up period.

Table 5.2 contains results of SMRs over the whole follow-up period. Comparing the SMR values from Table 5.2 with the values of coefficients f (SMR for non-exposed liquidators) from Table 5.3, it can be seen that the confidence intervals of these two estimates for various death causes are practically the same.

Results of estimation of the radiation risk coefficient for the mortality (ERR per Sv) are presented in Table 5.3. As follows from Table 5.3, the ERR values obtained using external and internal controls are close and the difference does not exceed, on the average, 10-15% (the greatest difference of 46% is observed for the death from cardiovascular diseases). It should be noted that the range of likelihood intervals derived using the approach proposed by the authors is very narrow, which suggests, as mentioned above, an increase in estimate accuracy.

As is seen from the presented results for all causes of death, except cancer and cardiovascular diseases, radiation risks are not statistically significant. For injuries and poisoning the dose relationship is actually inverse: the risk is decreasing with dose.

The ERR of death from malignant neoplasms of 2.11 (1.31, 2.92 95% CI) (with external control) and 2.04 (0.45, 4.31 95% LI) (with internal control) are statistically significant for the considered dose interval (0.005-0.3 Sv).

Thus, the results of the study lead us to conclude that there is a dose response relationship for mortality

from cancer in the cohort of liquidators. Given the above considerations and remembering that no account was taken of the minimal latent period (10 years) preceding the development of malignant neoplasms, the derived values of risk should be treated as preliminary.

It should be also recognized that even with reliable estimates of risk, the dose values being low, induction of radiogenic cancers will be insignificant. If the maximum risk estimate of 2.04 Sv^{-1} is adopted, the attributive risk of induction of radiogenic cancers will be 20% (with the mean dose 0.1 Sv), which corresponds to 20 annual radiation-induced deaths per 100,000 liquidators.

In conclusion we would like to point out that the approach to estimation of risk coefficients using the relative age distribution of spontaneous mortality normalized to national rates (external control) seems to be justified. The risk coefficients (ERR per Sv) estimated with the external and internal controls appear to be close each other. The values of SMR (Table 5.2) and the coefficient f (Table 5.3) and their confidence intervals for various death causes, which reflect no dose response, are also very close. We believe that the proposed approach will have an advantage for rare death causes, for example leukemia, when the accuracy of determination of spontaneous mortality in strata is not very high.

5.3. Conclusion

1. The mortality in liquidators is mostly lower than the all-Russian one and correlates with the trends in the corresponding age groups of the Russian population. The SMR for liquidators varies from 0.62 to 0.90.
2. The observed pattern of mortality is consistent with the predicted. At present the percentage of deaths from malignant neoplasms is about 10%, deaths from injuries and poisoning - 30%. Predominant are deaths from cardiovascular diseases which account for 40% of the overall mortality.
3. The values of the excess relative risk per unit dose (ERR Sv^{-1}) for malignant neoplasms and cardiovascular diseases are estimated as 2.11 (1.31, 2.92 95% CI) and 0.54 (0.18, 0.91 95% CI), (external control), and as 2.04 (0.45, 4.31 95% CI) and 0.79 (0.07, 1.64 95% CI) (internal control), respectively. The risk of death from all noncancer causes is not statistically significant and close to zero. The derived estimates of risk coefficients, however, are preliminary.

References

1. *Tsyb A.F., Dedenkov A.N., Ivanov V.K., Stepanenko V.F., Pozhidaev V.V., Pitkevich V.A., Matveenko E.G., Ispenkov E.A., Stadnik O.E., Maksyutov M.A., Gagin E.A., Airapetov S.A., Polsky O.G., Turaev R.N., Romanenko A.E., Ledoshchuk B.A., Omelyanets N.I., Sytnik A.S., Buriak V.N., Stezhko V.A., Losev G.A., Linge I.I.* Development of All-Union Registry of persons exposed to radiation as a result of the Chernobyl accident//Medical Radiology. - 1989. - No 7. - P. 3-6 (in Russian).
2. *Shigematsu I., Ito C., Kamada N., Akiyama M. and Sasaki H., eds.* Effects of A-bomb radiation on the human body. - Tokyo, Japan: Harwood Academic Publishers, Bunkodo Co., Ltd., 1995.
3. *Pitkevich V.A.(b), Ivanov V.K., Chekin S.Yu., Tsyb A.F.* About exposure burden for the Chernobyl emergency workers registered in the Russian National Medical and Dosimetric Registry//Radiation Biology. Radioecology. - 1996. - V. 36, Issue5. - P. 747-757 (in Russian).
4. *Pitkevich V.A., Ivanov V.K., Tsyb A.F., Maksyoutov M.A., Matiash V.A., Shchukina N.V.* Exposure levels for persons involved in recovery operations after the Chernobyl accident. Statistical analysis based on the data of the Russian National Medical and Dosimetric Registry (RNMDR)//Radiat. Environ. Biophys. - 1997. - V. 36, No. 3. - P. 149-160.
5. *BEIR V.* Committee of the biological effects of ionizing radiation. The Health Effects on Populations of Exposure to Low Levels of Ionizing Radiation. - Washington: National Academy Press, 1990.
6. *ICRP.* Recommendations of the International Commission on Radiological Protection. ICRP Publication 60. - Oxford: Pergamon Press, 1991.
7. *Shimizu Y., Pierce D.A., Preston D.L., Mabuchi K.* Studies of the mortality of atomic bomb survivors. Report 12, Part II. Non-cancer mortality: 1950-1990//Radiation Research. - 1999. - V. 152, N 4. - P. 374-389.
8. *Gofman J.* Radiation and human health. - San Francisco: Sierra Club Books, 1981.

9. *Ivanov V.K., Tsyb A.F., Maksoutov M.A., Pitkevich V.A., Gorsky A.I., Rastopchin Eu.M., Korelo A.M., Chekin S.Yu., Konogorov A.P., Nilova E.V.* Radiation epidemiological analysis of the data of the National Chernobyl Registry of Russia: prognostication and facts nine years after the accident//Radiation Protection Dosimetry. - 1994. - N 64. - P. 121-128.
10. *Ivanov V.K., Tsyb A.F., Maksoutov M.A., Rastopchin Eu.M., Gorsky A.I., Konogorov A.P., Chekin S.Yu., Pitkevich V.A., Mould R.F.* Cancer morbidity and mortality among Chernobyl accident emergency workers residing in the Russian Federation//Current Oncology. - 1995. - N 2. - P. 102-112.
11. *Breslow N.E., Day N.E.* Statistical Methods in Cancer Research. Vol. II. - The Design and Analysis of Cohort Studies. Scientific Publication 82. - Lyon: IARC, 1987.
12. *Preston D.L., Lubin J.H., Pierce D.A.* EPICURE User's Guide. - Seattle: Hirosoft International Corp., 1992.
13. *United Nations Scientific Committee on the Effects of Atomic Radiation.* Fiftieth session of UNSCEAR "Radiation-related cancer resulting from the Chernobyl accident". - Vienna, 2001.
14. *Ivanov V.K., Rastopchin E.M., Gorsky A.I., Rvkin V.B.* Cancer incidence among liquidators of the Chernobyl accident: solid tumors, 1986-1995//Health Physics. - 1998. - V. 74(3). - P. 309-315.
15. *Ron E., Preston D.L., Mabuchi K., Thompson D.E., Soda M.* Cancer incidence in atomic bomb survivors. Part IV: Comparison of cancer incidence and mortality//Radiation Research. - 1994. - V. 137. - P. S98-S112.
16. *Thompson D.E., Mabuchi K., Ron E., Soda M., Tokunaga M., Ochikubo S., Sugomoto S., Ikeda T., Terasaki M., Izumi S., Preston D.L.* Cancer incidence in atomic bomb survivors. Part II: Solid tumors, 1958-1987//Radiation Research. - 1994. - V. 137. - P. S17-S67.
17. *Ivanov V.K., Maksoutov M.A., Chekin S.Yu., Kruglova Z.G., Petrov A.V., Tsyb A.F.* Radiation-epidemiological analysis of incidence of non-cancer diseases among the Chernobyl liquidators // Health Physics. - 2000. - 78(5) P. 495-501.
18. *International Classification of Diseases, 9th Revision.* - Geneva: WHO, 1977.
19. *Ivanov V.K., Gorsky A.I., Maksoutov M.A., Tsyb A.F., Souchkevitch G.N.* Mortality among the Chernobyl emergency workers: estimation of radiation risks (preliminary analysis)//Health Physics. - 2001. - 81(5) P. 514-521.
20. *Cox D.R. and Hinkley D.V.* Theoretical Statistics. - London: Chapman and Hall, 1974. - P. 25.
21. *Pierce D.A., Shimizu Y., Preston D.L., Vaeth M., Mabuchi K.* Studies of the mortality of atomic bomb survivors. Report 12, Part I. Cancer: 1950-1990//Radiation Research. - 1996. - V. 146. - P. 1-27.

Review of Epidemiological Finding in Study of Medical Consequences of the Chernobyl Accident in Ukrainian Population

Anatoly Ye. PRYSYAZHNYUK, Volodymir G. GRISHTSHENKO,
Zoya P. FEDORENKO*, Ludmila O. GULAK*, Mykola. M. FUZIK

*Scientific Center for Radiation Medicine of Academy of Medical Science of the Ukraine,
53, Melnikov str., Kiev, 04050, Ukraine. E-mail root@ucr.kiev.ua*
**Institute of Oncology of Academy of Medical Science of the Ukraine,
33/43, Lomonosov str., Kiev, 03022, Ukraine. E-mail root@ucr.kiev.ua*

Abstract

Evaluation of the health status of different groups of the Ukrainian population affected by the Chernobyl accident is one of the most important problems in elimination of the consequences of the Chernobyl disaster. A lot of scientific researches devoted to study of health effects and based on established registers of victims of the Chernobyl accident had drawn conclusion about worsening of health of main groups of the affected population: Chernobyl accident recovery operation workers, evacuees from Prypyat city and 30km zone, and residents of the most contaminated with radionuclides territories. Most remarkable stochastic effect of radiation due to the Chernobyl accident is increase of thyroid cancer incidence rate in the above-mentioned groups of the Ukrainian population. For female breast cancer and some other solid cancers there are suggestions of increases. Further observation is needed for long term stochastic and non-stochastic effects.

1. Introduction

The accident at the Chernobyl Nuclear Power Plant on April 26th, 1986 is an unprecedented complicated and large-scale disaster in views of its origin, spreading of radionuclides on relatively large territories and the number of affected population. The release of dangerous radioactive substances diffused over the wide areas of Ukraine, Belarus and Russia. Chernobyl accident recovery operation workers (CAROW), who participated in elimination of the consequences of the accident, as well as inhabitants of territories neighbouring Chernobyl received substantial dose of radiation.

According to National Report (2001) [1], during 15 years after the accident the rural population of the Ukraine received 46.21 thousand person-Sv of accumulated collective dose. Average external dose in the rural inhabitants during that period constituted 0.6-41 mSv. Average accumulated external and internal dose per person in the territories with a density of nuclear fall-out more than 555 kBq/m² exceeded 70 mSv.

Average external effective dose to the evacuated inhabitants of the 30-km zone formed 20-30 mSv; Prypyat city - 10-12 mSv and Chernobyl city - 20 mSv. Taking into account the internal component, this evaluation should be doubled. The main group of CAROW who participated in elimination of the accident consequences in 1986 have received mean dose of 100-200 mSv, and CAROW in 1987 - 50-100 mSv.

Doses to thyroid for the population of the contaminated territories have shown significant burden on this organ, especially in children. Estimated average of thyroid dose equivalent in the most contaminated areas constituted 187 - 220 mSv in adults and children, while 877-1360 mSv only in children. Collective dose to thyroid in Ukrainian children is estimated to be 400,000 person-Gy, and in the most contaminated districts - 57,000 person-Gy [2].

Evaluation of health status of the population affected by the Chernobyl accident is one of the most important problem in elimination of the consequences of the Chernobyl disaster. According to regulation of

Ukrainian government, there was established State Registry of Ukraine of persons affected by the Chernobyl accident (SRU). In 2000 there were registered 1,258,241 persons, including 249,000 CAROW, 71,510 evacuees and 193,250 children [1]. Health care system in Ukraine and principles of activity of SRU are described in details by [3].

To follow up haematological and thyroid cancer consequences two special registries are in operation; Ukrainian Haematological Registry at Scientific Centre for Radiation Medicine, and Morphological Registry of Thyroid Cancer at Kiev Research Institute of Endocrinology and Metabolism.

The main cancer epidemiological studies related to the Chernobyl consequences are based on a data base of National Cancer Registry (NCR), which was established in 1989 and covers all territory of Ukraine. Personal information about all cancer cases is collected in NCR using a network of regional and city cancer registries [4, 5, 6]. In the last years joint efforts between Research Institute of Oncology and Scientific Centre for Radiation Medicine allowed to establish a frame of special sub-registry of NCR: cancer patients from the sufferers by the Chernobyl accident (CAROW, evacuees, and people still living in the contaminated territories). Before these registries, in Ukraine since 1953 there existed a system of cancer registration based on paper documents which were filled in all cancer hospitals (oncological dispensaries).

Results of studies in the above-mentioned institutes have been published in periodical medical literatures in Russian, Ukrainian languages as well as in proceedings in national and international symposia, conferences, congresses and another scientific forums. The main purpose of the current paper is review of publications performed and devoted to epidemiological researches of health status, especially about leukaemia and solid cancer in the groups of the Ukrainian population affected by the Chernobyl accident.

2. Somatic disorders in the main groups of population affected by the Chernobyl accident

2.1. Health status of residents in the contaminated territories with radionuclides

There were observed significant changes of health status of the population still living in the contaminated territories with radionuclides [7]. During 1988-1999 prevalence and incidence of diseases in these people increased by more than 2 times (from 620.9 to 1275.6 ‰ and from 305.5 to 746.0 ‰, respectively). Increases of morbidity were observed in almost all diseases classes, especially blood and blood circulation classes (10.8-15.4 times), endocrine pathology (4.1-8.1 times), neurological system and sense organs (3.8-5.0 times), skin and underskin cellulose (4.0-4.6 times). There were also observed more than two fold increases in the level of morbidity of digestive organs, urinarygenital and muscular-skeletal systems. It should be pointed out that the level of morbidity in the contaminated areas has exceeded the Ukrainian population level since 1993-1994.

There was observed a tendency that morbidity in inhabitants of the contaminated areas depends on the level of contamination. Since 1988 through 1997 the most remarkable increase was observed in the population of the territories with the highest level of contamination (so-called the 2nd zone of “obligatory resettlement”) - by 4.2 times. In the areas with the intermedium level of contamination (so-called the 3rd zone of “guaranteed voluntary resettlement”) morbidity increased by 2.3 times. And in the areas with the lowest level of contamination (so-called the 4th zone of “enhanced radiation control”) - only by 1.4 times. Only in the 2nd zone, however, there was observed significantly higher level of pathology in comparison with the Ukrainian population level. Such difference in the levels of morbidity of inhabitants in the different zones was demonstrated for almost all diseases classes. Attention should be drawn to the higher excess of mental disorders in all contaminated territories. In the 2nd zone the maximal level of mental disorders incidence reached 69.7 ‰ rather 4.4-5.4 ‰ in the Ukrainian adult population.

There was performed an incidence cohort study of inhabitants in the contaminated territories with different dose of thyroid gland irradiation [7], which registered high relative risks of blood circulation diseases, especially cerebrovascular pathology and muscular-skeletal system.

As pointed out [8, 9] since 1990-1991 a sign of demographical crisis has been observed, peculiarities of which are a significant decrease of birth-rate and a steep increase of mortality, including a high level of infant mortality. That happened in the negative radiation-ecological situation due to the Chernobyl disaster and its consequences. Forecasting calculation suggests worsening of the main demographical indexes in the contaminated territories. It is difficult, however, to estimate the size of load due to ionising radiation in the worsening demographical situation.

2.2. Health status of Chernobyl accident recovery operation workers (CAROW)

During the last period of time there were registered significant changes toward worse health status of CAROW [10, 11]. The proportion of healthy persons among this relatively young and healthy population at the moment of participation in elimination of the Chernobyl consequences decreased from 78.7% to 10.3%. In the people who have received external dose of radiation more than 250 mSv the percentage of healthy persons decreased to 7.2% due to increase of non-cancer chronic pathology which is the leading cause in their invalidity and mortality. There were observed increases of morbidity due to neurological diseases, diseases of sense organs, endocrine system, blood circulation, digestive organs, urinogenital system, and blood and haemopoetic system. The levels of these pathologies exceeded the incidence figures in the adult population of Ukraine.

There was observed a high level of psychiatric disorders incidence, especially in 1990-1993 [12]. In the structure of all diseases priority belongs to digestive organs pathology, system of blood circulation, neurological system and sense organs [13]. These three diseases classes compose 85-87% from all causes of invalidisation.

According to epidemiological cohort studies [14] the most significant increase of prevalence and incidence of chronic non-cancer diseases was observed in CAROW of 1986-1987 in comparison with persons who participated in the later period of time. Fourteen years follow-up of CAROW who had acute radiation disease demonstrated high risks of leukaemia and combined forms of immunodeficit. In a third of these patients there were observed relapse of skin lesions. In clinical symptomatology there was observed domination of radiation cataracts, hypothyroidism, organic pathology of nervous system. About 90% of recovered patients from acute radiation diseases are severe invalids. The main cause of death of them is sudden heart death. Obtained data [13] suggest a relationship between dose of irradiation and chronic non-cancer morbidity among CAROW.

In CAROW there were observed annual increase of mortality. The level of CAROW mortality approximated to figures of the mortality in the Ukrainian population of labourable ages [12]. In the last six years there was observed two fold annual increase of death rate of blood circulation system diseases, respiratory, digestive systems and endocrine pathology. In the structure of causes of death the first place belongs to pathology of blood circulation system.

2.3. Health status of the adult population of evacuees

According to State Registry of the Ukraine (SRU) [15, 16], in the adult population of evacuees from Prypyat city and the 30-km zone around Chernobyl NPP there were observed negative tendency of health status. Since 1988 through 1999 the percentage of healthy persons decreased from 67.7 % to 29.0 %. In the same time the relative frequency of pathology increase from 31.5 % to 71.0 %. During the above-mentioned period of time the prevalence of diseases increased by more than 3 times, and the incidence - by 2 times.

The morbidity level was higher rather than the population level for the next classes of diseases: pathology of endocrine system, blood and haemopoetic system, mental disorders, neurological system and sense organs, system of blood circulation, digestive, and muscular-skeletal systems.

In evacuees there was observed 1.5 fold increased incidence of thyroid gland pathology due to the

acquired hypothyroidism, thyroiditis and non-toxic nodular goiter. Annual level of thyroid pathology in female was higher rather than in male. There is an increase of this pathology with age, and more significant increase was observed in the people older 30.

There are some peculiarities in the structure of evacuees' morbidity. In the early post-accidental period the leading role was mental disorders which relative frequency reached 14%. In the following years the leading places belonged to blood circulation diseases, respiratory, neurology systems and sense organs, and digestive organs.

There was performed a special cohort study of evacuees' morbidity [16] with different terms of evacuation from Prypyat city and the 30-km zone around Chernobyl NPP: the first twenty four hours, 8-12 days and 19-50 days. The highest level of morbidity was observed in Prypyat inhabitants of the earliest evacuation, the prevalence figure of which in 1988-1998 composed 7780 ± 212.4 ‰. The lowest level of morbidity was observed in the sub-cohort of evacuees during 19-50 days after the accident. The level of prevalence was 3124 ± 108.8 ‰, two times lower than the earliest sub-cohort. The intermedium level was observed for 8-12 days evacuees; 5436.6 ± 62.2 ‰ of prevalence.

A study of evacuees' mortality pointed out that at the present time its level does not exceed the population level. Nevertheless, in separate years (1993, 1994) the mortality level in teenagers (15-17 years old) was higher than in 18-29 years and corresponded with the mortality in older population groups. In the structure of death causes the highest relative frequency was observed due to blood circulation diseases (47.6-83.1 %), neoplasms (7.4-16.5 %), and traumas and poisoning (2.7-19%).

2.4. Health status of children affected by the Chernobyl accident

The percentage of healthy children who were evacuated or born from CAROW decreased from 30% in the first post-accidental years to 2.8 - 5.0% [17]. The percentage of invalid children affected by the Chernobyl accident by four times exceeds the Ukrainian population level

There was revealed an increase of somatic diseases prevalence during the follow-up period. In 1999 the level of all diseases prevalence (49,967 per 10,000 children) was twice the figure in 1987-1988 (25,948 per 10,000 children). The most remarkable changes were registered in index of prevalence of digestive organs diseases (4,659 in 1988 and 10,122 in 1999 per 10,000 children), nervous system diseases (2,369 and 4,350 per 10,000 children, correspondingly).

Comparison of morbidity figures with those in the identical age groups of non-affected children suggests a significant difference between two groups (in 1999 by 3 times higher in the affected children). A tendency of increase was determined distinctly in digestive organs pathology, nervous system and the diseases in pathogenesis of which the main the role belongs to changes of immune system [17, 18, 19].

There was denoted that the main risk of health damage in children living in the contaminated territories were connected with blood diseases, haemopoietic system, endocrine system pathology, digestive organs disorders and mental disorders [19].

The increased level of morbidity may be related with both radiological and non-radiological factors (contamination of soil with radionuclides, heavy metals, pesticides, chemical composition drinking water and so on). Portion of ionising radiation contributing to the increased morbidity is considered from 2 to 20 %.

The most unfavourable changes were observed in the children with high dose of irradiation of thyroid gland (over 200 cGy) and *in utero* irradiated children. Among them the percentage of practically healthy does not exceed 2.6-5.0 % [13]. Since 1986 there were observed determined effects of irradiation on thyroid gland: primary functional reaction observed in 1986-1987, beginning of formation chronic autoimmunal thyroiditis in 1990-1992, and clinical realisation of diseases - in 1992-1993.

In the latest period after the Chernobyl accident the forecasting of health status of the children affected

by radiation is unfavourable [20]. The higher proportion of these children has developed pathology in most organs and systems: thyroid gland - 32.6 % (15.4 % in the control group, $P<0.05$), respiratory system - 26.0 % (13.7 % in the control group, $P<0.05$), heart-vessel system (including vegeto-vessel distonia) - 57.8 % (31.8 % in the control group, $P<0.05$), gastro-intestinal tract - 18.9 % (8.9 % in the control group, $P<0.05$), immunological deficiency - 43.5 % (28.0 % in the control group, $P<0.05$), and endocrine infertility in girls - 32.0 % (10.5 % in the control group, $P<0.05$).

3. Cancer incidence rates in main groups of population affected by Chernobyl accident.

Cancer incidence rates after the Chernobyl accident were studied in the population of the territories of Kiev and Zhytomir regions neighbouring with the nuclear power plant. The most contaminated districts included in the study were Narodichy and Ovruch districts of Zhytomir region, Ivankov, Poleskoye and now unpopulated former Chernobyl districts. At the moment of the Chernobyl accident these five districts accounted 274 thousand of population including 59,200 children. In 2000 the four most contaminated districts (without unpopulated Chernobyl district) had 125,000 residents (including 21,600 children). During the period of observation for 1980-2000 there were registered 11,400 cases of cancer and leukaemia, including 126 cases in children [21].

Cancer incidence rates for the period of 1990-1997 were studied in Chernobyl accident recovery operation workers (CAROW) of 1986 and 1987 years who were chosen from 6 regions of Ukraine: Dnepropetrovsk, Donetsk, Kharkov, Kiev, Lugansk regions and Kiev city [22]. The sample population containing the records on 95,000 CAROW as of 1990 was constructed based on the data acquired from the State Registry of Ukraine of persons affected due to the Chernobyl accident (SRU). Cancer incidence in the Ukrainian evacuees was studied based on the data base contained in SRU. In 1990 there were accounted 51,500 evacuees [22, 23].

3.1. Cancer incidence rates in residents of the most contaminated territories

Cancer incidence rates in the population living in various regions are illustrated in Figure I for the period 1980-2000 [21]. Cancer rates in the populations still living in the most contaminated districts were consistently lower than for the overall Ukraine or for Kiev and Zhytomir regions. Cancer incidence rates in all four groups show a similar pattern of temporal increase. Regression coefficients, which characterise the increment per year, do not differ significantly [21, 22, 23, 24].

Comparison of standardised incidence ratios (SIR) for all cancers in the most contaminated districts is shown in Table 1 for various periods of observation. Irrespective of the sub-periods for 1990-1993, 1994-1997 and 1998-2000, there is no significantly increased cancer incidence for all cancers in the residents of

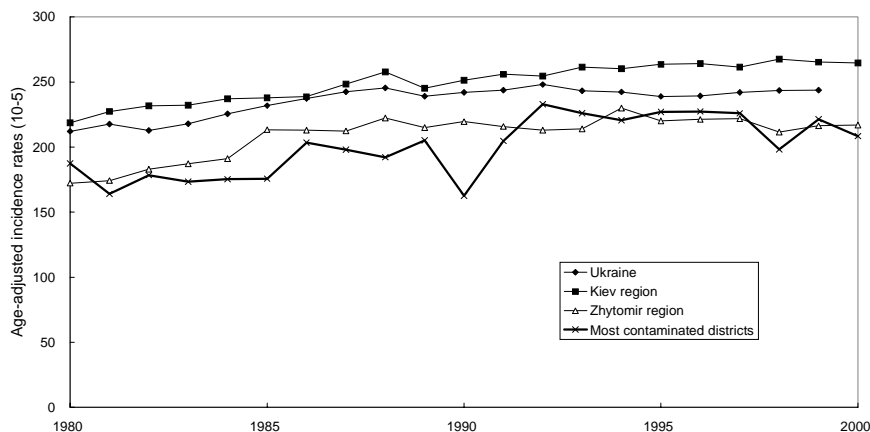

Fig. I. Incidence rates for all cancers in various regions of the Ukraine. Males and females.

Table 1. Standardised incidence ratios for various cancers in residents of the most contaminated districts in Zhytomyr and Kiev regions.

Years of observation	Number of person-years of observation	Observed numbers of cases	Expected numbers of cases	SIR (%)	95% CI
All cancers (ICD-IX 140-208), males and females					
1990-2000	1660971	5378	6781	79.3	77.2 - 81.4
1990-1993	654501	2143	2607	82.2	78.8 - 85.7
1994-1997	556631	1820	2283	79.7	76.1 - 83.4
1998-2000	449839	1415	1891	74.8	70.9 - 78.7
Leukaemia and lymphoma (ICD-IX 200-208), males and females					
1990-2000	1660971	310	295.7	104.8	93.2 - 116.5
1990-1993	654501	127	114.1	111.3	92.8 - 131.5
1994-1997	556631	100	98.8	101.2	82.3 - 122.0
1998-2000	449839	83	82.8	100.3	78.7 - 121.8
Thyroid cancer (ICD-IX 193), males and females					
1990-2000	1660971	107	57.3	186.7	151.4 - 222.1
1990-1993	654501	24	22.4	107.2	68.6 - 154.4
1994-1997	556631	48	19.3	249.1	183.6 - 324.6
1998-2000	449839	35	15.60	224.4	150.1 - 290.8
Breast cancer (ICD-IX 174) females					
1993-1997*	389645	162	107.8	150.3	127.1 - 173.4
1998-2000*	240917	97	64.1	151.3	121.2 - 181.4

*Because of significant territorial variation of breast cancer incidence in the Ukraine SIR was calculated on a base of local standard 1980-1992.

the most contaminated districts.

For leukaemia and lymphomas (Figure II) in the population from the contaminated districts there were pronounced annual incidence fluctuations. Such annual figures showed an increase for the period 1987-1991 and 1999-2000. Analysis of aggregated time periods for leukaemia and lymphoma incidence rates showed higher levels in 1986-1991, 1992-1997 and 1998-2000 in comparison with the pre-accident period (1980-1985) (Table 2). When individual subtypes of these diseases were evaluated, a comparable increase was seen for lymphoid leukaemia in 1986-1991 and (non-significantly) for 1992-1997, 1998-2000. For myeloid leukaemia there was an increase in 1986-1991 and 1998-2000 [21, 24].

A screening (ascertainment) effect could be supposed for the first after-accident period. The overall regression coefficients for this entire period do not suggest any significant difference among the different

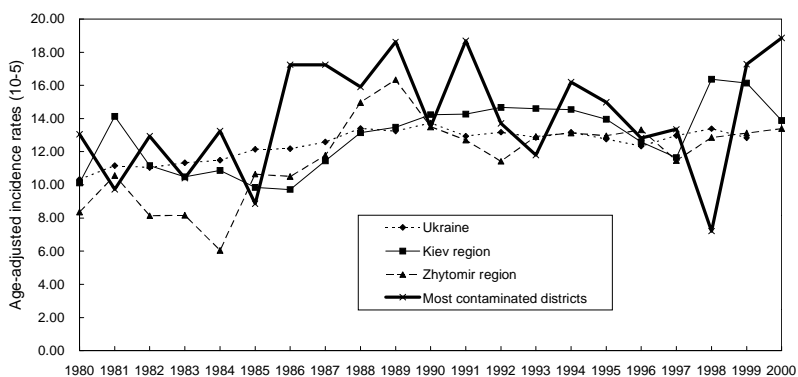

Fig. II. Incidence rates for leukaemia and lymphoma in various regions of the Ukraine. Males and females.

Table 2. Leukaemia and lymphoma incidence rates in the population (children and adults) of 5 most contaminated districts in Zhytomyr and Kiev regions, Ukraine.

Disease	ICD9 code	Mean annual age-adjusted incidence rate (10^{-5})			
		1980–1985	1986–1991	1992–1997	1998–2000
Leukaemia and lymphoma	200–208	10.12 ± 0.75	15.63 ± 1.06	13.41 ± 1.10	13.82 ± 1.52
Lympho- and reticulosarcoma	200, 202	1.84 ± 0.33	2.70 ± 0.41	3.70 ± 0.58	3.36 ± 0.90
Hodgkin's disease	201	1.82 ± 0.34	2.47 ± 0.48	2.10 ± 0.48	1.23 ± 0.50
Multiple myeloma	203	0.54 ± 0.16	1.03 ± 0.25	0.78 ± 0.22	1.38 ± 0.40
Lymphoid leukaemia	204	3.08 ± 0.40	4.93 ± 0.59	2.97 ± 0.49	4.11 ± 0.75
Myeloid leukaemia	205	0.49 ± 0.17	1.99 ± 0.41	1.06 ± 0.30	2.32 ± 0.62
Other leukaemias	206–208	2.35 ± 0.36	2.51 ± 0.41	2.81 ± 0.53	1.41 ± 0.53

territories [21]. Because of large-scale out-migration of the people from the contaminated areas, there is a concern that some members of the group of highest potential risk may have been lost to follow-up.

On the western part of Ukraine there was performed a study of morbidity and mortality rate of leukaemia and lymphoma in relation to the Chernobyl accident during the period 1981-1994 [25, 26, 27, 28]. There were studied the population in two regions: Rivne and Ivano-Frankivsk, which correspond to the contaminated and the non-contaminated regions as a result of Chernobyl accident, respectively. The study has revealed that leukaemia and lymphoma morbidity and mortality rate increased mainly during the period 1987-1994 in both regions, irrespectively of their being or not being contaminated by radionuclides. The most pronounced increase was observed in older age groups of the population of two regions. Besides, among different forms of these diseases there were registered increases of non-Hodgkin's lymphoma, chronic lymphocytic leukaemia and multiple myeloma.

The radiation-related origin of the dramatic increase of thyroid cancer incidence is not in doubt [29, 30]. In Ukraine, the overall incidence of thyroid cancer was approximately doubled during the post-Chernobyl (Figure III). In the Kiev region and city of Kiev, where some 70% of the population of Pripjat and the 30-km zone settled, the increases were significant (Figure IV). A dramatic increase occurred in 1996 and 1999 for the most contaminated areas [21].

In the 5 most contaminated districts, female breast cancer rate remained relatively stable during 1980-1992 (Figure V), though lower than in Ukraine as a whole or in regions that include contaminated districts. In 1993-2000, however, an increase in the rate of female breast cancer (Table 1) occurred in the 5 most contaminated districts; which now corresponds more closely to the rate typical of Ukraine as a whole [21, 22, 23].

A molecular-genetic study at Institute of Urology and Nephrology of AMS of Ukraine in collaboration

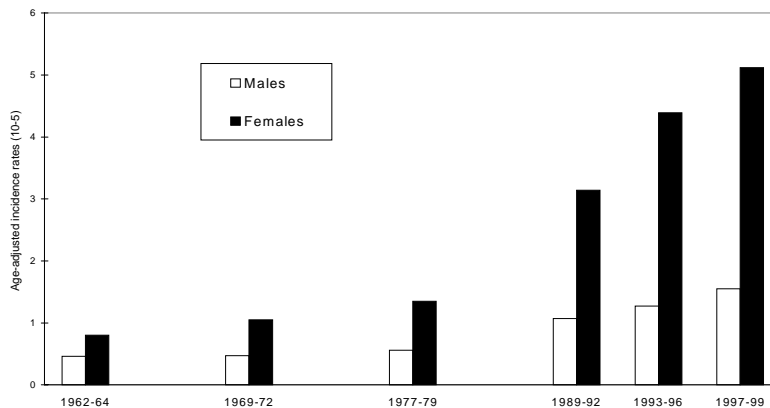

Fig. III. Mean annual age-adjusted thyroid cancer incidence rates in the Ukraine.

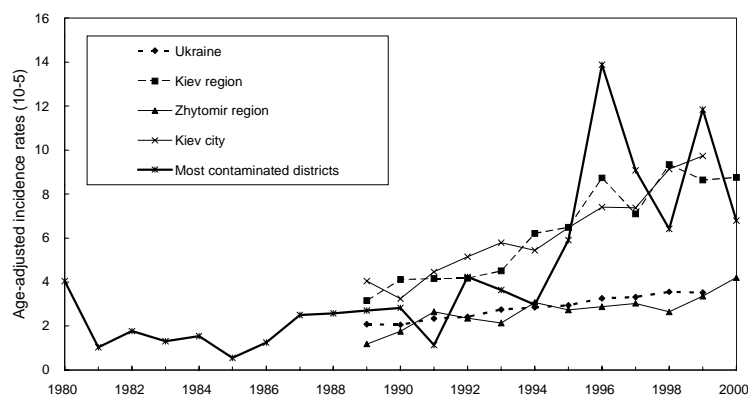

Fig. IV. Thyroid cancer incidence rates in various regions of the Ukraine.

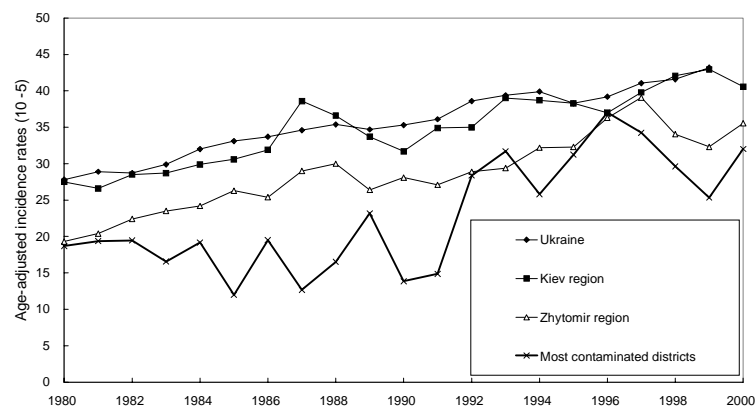

Fig. V. Breast cancer incidence rates in various regions of the Ukraine.

with medical experts of University of Osaka (Japan) gave the evidence that, among prostate adenoma patients who are inhabitants of the contaminated territories, in 53% there happened mutagenic inactivation of tumour-suppressional gene, p53 and in 96% - development of pre-cancer changes in urotelii of urinary bladder [31]. The authors has connected these changes with chronic influence of low level ionising radiation which leads to genetic instability with possible development to chiefly invasive cancer of urinary bladder.

3.2. Cancer incidence in Chernobyl accident recovery operation workers (CAROW).

Standardised cancer incidence ratios (SIR) of different organs in CAROW of 1986, 1987 are illustrated in Table 3 for periods 1990-1993 and 1994-1997. Significant excess is observed in CAROW for all cancers in the first years following the accident, especially for the period 1990-1993 [22, 23].

Leukaemia and lymphoma are diseases that have drawn special attention after the Chernobyl accident. A study of leukaemia and lymphoma in a cohort of Russian recovery operation workers has shown excess of leukaemia and elevated radiation risks [32, 33, 34], but the data weren't confirmed in a case-control study [30].

In Ukraine an international haematological review was performed in relation to diagnosis validation evaluation of diagnostic material quality. The international experts panel has proved the adequacy of diagnostic criteria applied in different regions of Ukraine as satisfying the international standards and high quality level of diagnosis of acute and chronic leukaemia [35, 36]. The percentage of confirmed cases of Hodgkin disease and non-Hodgkin lymphomas for which histological slides were available was high, but the availability of data from the different sources (oncological or haematological dispensaries) has to be improved.

Table 3 Standardised incidence ratios for various cancers in Chernobyl accident recovery operation workers of 1986 and 1987.

Years of observation	Number of person-years of observation	Observed numbers of cases	Expected numbers of cases	SIR (%)	95% CI
All cancers (ICD-IX 140-208), males					
1990-1997	577536	1496	1354	110.5	104.9 - 116.1
1990-1993	263084	538	443	121.5	111.2 - 131.8
1994-1997	314452	958	911	105.1	98.5 - 111.8
Leukaemia and lymphoma (ICD-IX 200-208), males					
1990-1997	577536	183	81.6	224.2	191.7 - 256.7
1990-1993	263084	81	31.8	255.0	199.5 - 310.5
1994-1997	314452	102	49.9	204.6	164.9 - 244.3
Thyroid cancer (ICD-IX 193), males					
1990-1997	577536	37	8.4	442.7	300.0 - 585.3
1990-1993	263084	13	3.3	393.0	179.4 - 606.6
1994-1997	314452	24	5.1	475.2	285.1 - 665.4
Breast cancer (ICD-IX 174), females					
1990-1997	39188	44	29.1	151.2	106.5 - 195.8
1990-1993	15913	12	10.9	110.2	47.9 - 172.6
1994-1997	23275	32	18.2	175.6	114.8 - 236.5

A study based on the data base from the SRU for CAROW who were exposed in the period 1986-1987, the leukaemia and lymphoma incidence rate was significantly elevated in the years 1990-1993 and 1994-1997 [22, 23].

Other group of investigators has followed the incidence of leukaemia in CAROW of 1986 and 1987 up to the end of 1996 [37, 38]. In a cohort of 74.7 thousand CAROW (aged 20-69) there were registered 48 leukaemia cases during 1987-1996. The results were tabulated for the entire period of follow-up. The SIR ratio values were relative to the comparable age and period-specific rate for Ukraine as a whole. SIR for all leukaemia (107.8%, 95% CI 77.3 - 138.3%) were not elevated for the whole period of time. SIR for chronic lymphoid leukaemia did not indicate changes. However, SIR for chronic myeloid leukaemia suggested a increase of this malignancy (SIR - 258.7; 95% CI 127.8 - 389.5%). In 1989-1991 there was observed high risk of leukaemia in CAROW of 1986 in comparison with CAROW of 1987 [39].

Russian CAROW from the same period displayed their increase in all types of leukaemia, chronic lymphoid leukaemia and chronic myeloid leukaemia [32, 33, 34]. In Belorussian CAROW (again from 1986-1987) excess of acute leukaemia was seen for 1990-1991 [40].

Besides, Table 3 demonstrates the most significant increases in thyroid cancer occurred in CAROW of 1986, 1987 in the periods 1990-1993 and 1994-1997 [22]. A statistically significant increase in breast cancer incidence rate was also observed in female CAROW of 1986, 1987 in the period 1994-1997, but not during 1990-1993 (Table 3).

3.3. Cancer incidence rate in evacuees from 30-km zone.

Standardised cancer incidence rates of different organs in evacuees are illustrated in Table 4 for the periods; 1990-1993, 1994-1997. There is some evidence of increase of this pathology in the above-mentioned group of sufferers by the Chernobyl accident. Leukaemia and lymphoma cases are significantly elevated only for the 1990-1993 sub-period [23]. The most significant increases occurred in thyroid cancer in both 1990-1993 and 1994-1997 sub-periods. About female breast cancer a small increase is suggested [22, 23].

Table 4 Standardised incidence ratios for various cancers in evacuees from 30 km zone.

Years of observation	Number of person-years of observation	Observed numbers of cases	Expected numbers of cases	SIR (%)	95% CI
All cancers (ICD-IX 140-208), males and females					
1990-1997	408882	870	1234	70.5	65.8 - 75.2
1990-1993	208805	432	618	69.9	63.3 - 77.8
1994-1997	200077	438	616	71.1	64.5 - 77.8
Leukaemia and lymphoma (ICD-IX 200-208), males and females					
1990-1997	408882	74	59.6	124.2	95.9 - 152.5
1990-1993	208805	43	30.0	143.4	100.5 - 186.3
1994-1997	200077	31	29.6	104.7	67.9 - 141.6
Thyroid cancer (ICD-IX 193), males and females					
1990-1997	408882	66	12.9	513.4	389.6 - 637.3
1990-1993	208805	23	6.4	362.0	214.1 - 510.0
1994-1997	200077	43	6.5	661.4	463.7 - 859.1
Breast cancer* (ICD-IX 174) females					
1990-1997	235072	72	52.3	137.7	105.9 - 169.5
1990-1993	119915	37	25.7	143.9	97.5 - 190.2
1994-1997	115157	35	26.6	131.7	88.1 - 175.3

*Because of significant territorial variation of breast cancer incidence in the Ukraine SIR was calculated on a base of local standard 1980-1992.

3.4. Cancer incidence rates in children sufferers by the Chernobyl accident

Children constitute a group vulnerable to radiation. Cancer incidence rates in the children population of the most contaminated districts in Zhytomyr and Kiev regions are provided in Table 5, including the data for the period before the accident (1980-1985). When compared to the pre-accident values (1980-1985), the only significant excess observed in children is for thyroid cancer diagnosed during 1992-1997 and for leukaemia during 1986-1991, though the latter result may have other explanations than radiation.

According to [41] there was observed a steep increase of thyroid cancer incidence rate in children and adolescents of Ukraine. Before the Chernobyl accident (1981-1985) the level of morbidity constituted 0.05 per 100,000 children. In the post-accidental period the dynamics of this pathology was: 0.11 in 1986-1990, 0.41 in 1991-1995, and 0.40 per 100,000 children in 1996-2000.

Status of haemopoietic system due to acute and chronic irradiation has been studied in 42,888 children inhabiting the four contaminated regions of Ukraine during 15 years after the Chernobyl accident [42, 43]. Data analysis suggested absence of excess leukaemia and lymphoma incidence rate during 1980-1999 in comparison with spontaneous background. But, in a group of 3,840 exposed children with high risks of oncohematological pathology [42], 11 cases of acute leukaemia were registered during the period of observation of this cohort.

There was also performed a study of the incidence of acute childhood leukaemia during 1980-1996 in 12 large territories of Ukraine including 4 regions which were contaminated by the Chernobyl accident [44, 45, 46]. This study has revealed an increase of acute childhood leukaemia incidence rate in most of the regions excluding Kiev city. Certain specificity of different types of leukaemia in children age groups of 0-4, 5-9, 10-14 was revealed. It should be pointed out that the incidence rate of acute leukaemia in 10-14 years increased mainly in the contaminated regions. Acute myeloid leukaemia had a tendency to increase in 10-14 years. In the post-accidental period (1986-1996) there was also observed an increase of inherited leukaemia in most of territories.

With relation to this finding there is a very interesting study of acute leukaemia occurrence among the children exposed *in utero* due to the Chernobyl accident [47]. To ascertain the effect of *in utero* radiation exposure and the development of leukaemia a review was undertaken of leukaemia subtypes occurring

Table 5 Standardised incidence ratio (SIR) for cancer in children population (0-14) of the most contaminated districts in Zhytomyr and Kiev regions.

Site of tumours (code ICD-IX) and years of observation	Number of person-years of observation	Observed numbers of cases	Expected numbers of cases	SIR (%)	95% CI
All cancers (140-208)					
1980-1985	337076	44	36.48	120.62	84.98 - 156.26
1986-1991	209337	44	22.69	193.95	136.64 - 251.26
1992-1997	150170	31	16.26	190.62	123.51 - 257.72
1998-2000	80656	7	8.70	80.46	20.86 - 140.07
1998-2000 (age 10-29)	107629	37	22.61	163.62	110.90 - 216.34
Leukaemia and lymphoma (200-208)					
1980-1985	337076	21	17.28	121.51	69.54 - 173.49
1986-1991	209337	27	10.75	251.11	156.39 - 345.84
1992-1997	150170	11	7.72	142.49	58.28 - 226.69
1998-2000	80656	2	4.13	48.47	(-18.71) - 115.66
1998-2000 (age 10-29)	107629	10	7.58	131.88	50.14 - 213.61
Leukaemia (204-208)					
1980-1985	337076	19	10.88	174.68	96.13 - 253.22
1986-1991	209337	22	6.78	324.35	188.82 - 459.89
1992-1997	150170	7	4.87	143.70	37.25 - 250.15
1998-2000	80656	0	2.59	0.00	0.00 - 0.00
1998-2000 (age 10-29)	107629	5	2.58	193.63	23.91 - 363.35
Thyroid cancer (193)					
1980-1985	337076	0	1.13	0.00	0.00 - 0.00
1986-1991	209337	2	0.69	289.84	(-111.86) - 691.53
1992-1997	150170	9	0.49	1824.77	632.59 - 3016.95
1998-2000	80656	1	0.28	362.91	(-348.40) - 1074.22
1998-2000 (age 10-29)	107629	6	1.14	527.32	105.38 - 949.27
All cancers except leukaemia and lymphoma, and thyroid cancer (140-208 less 200-208, 193)					
1980-1985	337076	23	18.07	127.29	75.27 - 179.31
1986-1991	209337	15	11.24	133.40	65.89 - 200.91
1992-1997	150170	11	8.05	136.65	55.89 - 217.40
1998-2000	80656	4	4.30	93.06	1.86 - 184.26
1998-2000 (age 10-29)	107629	21	13.89	151.16	86.51 - 215.81

among the children born in the year of Chernobyl accident (1986) and followed 10 years of post-exposure in the most affected region of the Ukraine (Zhytomyr region). A comparison of leukaemia cumulative incidence rates was made between the children from the exposed and the non-exposed (Poltava region) territories. For all cell types of leukaemia there was observed a significantly increase of incidence in the exposed region. The rate of acute lymphoblastic leukaemia was more than three times greater in the exposed region than in the unexposed region. The results of this study suggest that the increased risk of acute leukaemia among those children born in 1986 and reside in the radioactively contaminated territories may be associated with exposure to radiation resulting from the Chernobyl accident.

4. Discussion and conclusion

The established system of follow-up, dispensation of sufferers by the Chernobyl accident allow to collect annually data about health status of different groups of these people. In this context it should be reminded that the health condition of sufferers by the Chernobyl accident as well as Ukrainian population as a whole are related not only with the consequences of Chernobyl, but with aggravation in the last years of economic, social and environmental conditions in Ukraine. The Chernobyl accident has caused a heavy impact on the environment of vast territories of Ukraine, significant worsening of the economic situation in state, disruption of social life in the contaminated areas, growing anxiety and fears among sufferers, as well

as certain biomedical effects on the people.

From the other side the exposed population undergo much more intensive and active follow-up of their status of health rather than do the general population. Implementation of modern screening procedures (for example ultrasound devices) have improved the quality of diagnostic procedures. These could in some degree influence on the registered figures of diseases. Meanwhile, these figures are basis for analysis and conclusions about long-term tendencies in health status of the population affected by the Chernobyl accident.

Similar trends in incidence rates for cancer were apparent in the different Ukrainian population groups directly affected by the Chernobyl accident (residents of the most contaminated districts, recovery operation workers and evacuees). There is excess of thyroid cancer [21, 22, 23, 24, 29, 30, 41]. For female breast cancer and some other solid cancers there are suggestions of increases. Further studies are required to confirm these tendencies along with evaluation of the effects of screening and improved registration quality. The small number of cases for certain types of cancer and the confounding effect due to out-migration mean that cancer monitoring and surveillance should include not only the contaminated districts but outside regions where such residents are relocated. The apparent increases at least in part may reflect differences in case ascertainment between the affected groups and the general population of Ukraine, not relating with a radiation-related effect [30, 48]. The existing data on cancer and leukaemia-lymphoma incidence after Chernobyl are based on the two registries: Chernobyl registry (SRU) and national cancer registry (NCR). This approach requires more comprehensive linkage between two registries.

References

1. Fifteen years of Chernobyl catastrophe. Experience of mitigation. National Report of the Ukraine, K.:Chornobylinterinform, 2001, 144 p. (in Ukrainian).
2. Ministry of the Chernobyl Affairs of Ukraine. Ten years after the accident at the Chernobyl nuclear power plant. Ukrainian National Report, Kiev (1996). (In Ukrainian).
3. Oleg Nasvit. Research and Managing Institution in Ukraine concerning the Radiological Consequences of the Chernobyl Accident. In: T. Imanaka (Ed) - Research Activities about Radiological Consequences of the Chernobyl NPS Accident and Social Activities to Assist the Sufferers by the Accident. Research Reactor Institute, Kyoto University, March 1998, pp.58-64.
4. Gulak L.O. Cancer register of the Ukraine: Experience of formation and usage in scientific researches and branch administration. Environment and Health, Kiev, 1 2, 1997, pp. 12-13. (In Russian).
5. Winkelmann R., Gulak L., Okeanov A., Remennik I. Cancer registration techniques in the New Independent States of Former Soviet Union /IACR, Lyon, 1998, 200 p.
6. 6 Gulak L.O. Methodological aspects of large scale cancer register formation. Oncology, Kiev, Vol. 3, 1 2-3, 2001, pp.198-202. (In Russian).
7. Buzunov V.A., Pirogova Ye.A., Tereshtchenko V.M. et al. Dynamic of adult population health living on contaminated with radionuclides territories in: Medical Consequences of the Chernobyl Accident, Monograph in 3 books."MEDECOL" interdisciplinary Scientific and Research Centre BIO-ECOS, Kiev, 1999, Book 1, -pp. 108-119. (In Russian).
8. Omelyanets N.I., Kartashova S.S. Medico-demographycal consequences . //Chernobyl catastrophe. - K., 1995. - P.414-417. (in Russian).
9. Omelyanets N.I., Kartashova S.S. , Dubova N.F., Savtchenko A.B. Integral estimation of Social - economic and demographyc condition in contaminated with radionuclides regions of the Ukraine, in: Remote medical consequences of the Chernobyl Catastrophe: Proceeding 2 international conference, 1-6 June, - K., 1998. - pp.102-103. (In Ukrainian).
10. Buzunov V.A., Strapko N.P., Krasnikova L.I. Time trend of health of Chernobyl NPP accident consequences liquidates. In: Medical Consequences of the Chernobyl Accident, Monograph in 3 books. "MEDECOL" Interdisciplinary Scientific and Research Centre BIO-ECOS, Kiev, 1999, Book 1, pp.65-85.
11. Buzunov V.A., Strapko N.P., Pirogova Ye.A. et al. Epidemiology of non-cancer diseases among Chernobyl

- accident recovery operation workers. / *International Journal of Radiation Medicine*, 2001, 3(3-4): 9-25.
12. Nyagu A.I., Loganovsky K.N., Chuprovsky N.U. et al. Neuropsychiatric effects in: V.G.Bebeshko, A.N.Kovalenko (Eds). - Book 2. Clinical aspects of the Chernobyl catastrophe. - K.: "MEDECOL" interdisciplinary Scientific and Research Centre BIO-ECOS, Kiev 1999, pp.154-186. (In Russian).
 13. Medical Consequences of Chernobyl nuclear power station accident. Book 2. Clinical aspects of the Chernobyl catastrophe. V.G.Bebeshko, A.N.Kovalenko (Eds).- K.: "MEDECOL" interdisciplinary Scientific and Research Centre BIO-ECOS, pp. 399. (In Russian).
 14. Medical Consequences of the Chernobyl Nuclear Power Plant Accident. Book 1. Epidemiology of Medical consequences of the Chernobyl NPP Accident. V.A .Buzunov, L.A.Likhtarev (Eds). "MEDECOL" interdisciplinary Scientific and Research Centre BIO-ECOS, Kiev 1999, pp.315. (In Russian).
 15. Buzunov V.A., Pirogova Ye.A., Prikashtchikova Ye.Ye., Strapko N.P. Dynamic health status adult population evacuated from 30 km zone and Pripjat city in Medical consequences of the Chernobyl Accident Monograph in 3 books."MEDECOL" interdisciplinary Scientific and Research Centre BIO-ECOS, Kiev, 1999, V. 1, -pp. 86-107. (In Russian).
 16. Buzunov V.A., Pirogova Ye.A., Repin V.S. at all. Epidemiologic studies of non-cancer incidence of adult population evacuated from Pripjat and 30-km zone surround the Chernobyl NPP. / *International Journal of Radiation Medicine*, 2001, Vol. 3(3-4).- pp.26-45.
 17. Korol N.A., Treskunova T.V., Duchota T.A. Children health status affected by accident on CNPP in: Medical consequences of the Chernobyl Accident, Monograph in 3 books."MEDECOL" interdisciplinary Scientific and Research Centre BIO-ECOS, Kiev, 1999, Book 1, -p. 120-134. (In Russian).
 18. Romanenko A.E., Bomko E.I., Bomko A.A. Estimation of health effects of long-term chronic exposure of the low lively radiation among children exposed in consequence of the disaster at the Chernobyl nuclear power plant //Low doses of ionizing radiation: biological effects and regulatory control: Proceeding of 1st int. conf., Seville, Spain, 17-21 November, 1997. - Vienna, 1997. - P. 326-329.
 19. Romanenko A.E., Bomko E.I., Kostenko A.I., Bomko A.A. Incidence of children resident on radioactively contaminated territories of Ukraine and chronically exposed to low doses of ionising radiation. / *International Journal of Radiation Medicine*, 2001, Vol. 3(3-4).- pp.61-70.
 20. Stepanova Ye. I. Medico-biological consequences of Chernobyl catastrophe in affected children population. "MEDECOL" interdisciplinary Scientific and Research Centre BIO-ECOS, Kiev, 1999, Book 2, -p. 5-32. (In Russian).
 21. Prisyazhnyuk A. et al. Results of long-term monitoring of solid cancers and leukaemia in population still living in the most contaminated with radionuclides territories of the Ukraine after the Chernobyl accident (preliminary report). In: International Conference "Fifteen Years after the Chornobyl Accident. Lessons Learned". Kiev, 2001. Chornobylinterinform. P. 3-118.
 22. Prisyazhniuk, A. et al. Epidemiological study of cancer in the Ukraine with reference to the Chernobyl accident. p. 199-228 in: Seventh Symposium on Chernobyl-Related Health Effects, Tokyo, 25-16 November 1998.
 23. Prisyazhnyuk A. Ye. et al. Malignant neoplasms in different groups of population affected by the Chernobyl accident. In: *International Journal of Radiation Medicine*, 2001, Vol. 1, No 1-2, P. 110.
 24. Prisyazhniuk, A., V. Gristchenko, V. Zakordonets et al. The time trends of cancer incidence in the most contaminated regions of the Ukraine before and after the Chernobyl accident. *Radiat. Environ. Biophys.* 34: 3-6 (1995).
 25. Wyhowska J., Lukawecki L., Mazurok A., Ciapka O., Fabryka A. The multiple myeloma morbidity before and after nuclear catastrophe in Chernobyl. A study of two administrative districts of the Ukraine: Rivnensk and Ivano-Frankovsk //Applied Biology Communications. - 1997. - 7, Suppl. 1. - P. 175.
 26. Lukawecki L., Vygovska Y., Prisyaznyuk A., Mazurok A., Tsiapka O., Masliak Z., Fabryka A. The chronic lymphocytic leukaemia morbidity before and after nuclear catastrophe in Chernobyl //Acta Haematologica Polonica. - 1998. -29, Suppl. - P. 119. (In Polish).
 27. Y.I.Vygovska, L.M.Lukavetsky, A.A.Mazurok, O.M.Tsiapka, A.V.Fabryka. Mortality rate caused by leukemia and lymphoma in Ukraine before and after Chernobyl catastrophe //Brit.J. of Haematology. - 1998.-102.-P.36.
 28. Y.I.Vygovska, L.M.Lukavetsky, A.Ye.Prisyaznyuk, A.A.Mazurok, O.M.Tsiapka, Z.V.Masliak, A.V.Fabryka, L.O.Karlyuk, A.S.Kalis. Haemablastosis incidence rate in representative territories of the Ukraine before and after

- Chernobyl accident /Ukrainian medical newes. - 1998. -2, 1-2. pp.252-253. (in Ukrainian).
29. Prisyazhniuk, A., O.A. Pjatak, V.A. Buzanov et al. Cancer in the Ukraine, post-Chernobyl. *Lancet*: 338(8778): 1334-1335 (1991)
 30. .United Nations. Sources and Effects of Ionizing Radiation. Volume I: Sources; Volume II: Effects. United Nations Scientific Committee on the Effects of Atomic Radiation, 2000 Report to the General Assembly, with scientific annexes. United Nations sales publication E.00.IX.3 and E.00.IX.4. United Nations, New York, 2000.
 31. Romanenko A., C.Lee, S.Yamamoto et al., Urinary bladder lesions after the Chernobyl accident: immunohistochemical assessment of p. 53, proliferation cell nuclear antigen, cyclin D 1 and p 21 WAF1/Cip 1. *Jpn. J. Cancer Res.* -1999. - 1 90. -p.144-153.
 32. Ivanov, V.K., E.V. Nilova, A.I. Gorsky et al. Leukaemia incidence in the population of the contaminated districts of the Bryansk region after the Chernobyl accident (1991-1996 data). in: Fifteen Years after the Chernobyl Accident. Lessons Learned. International Conference, Kiev, 18-20 April 2001, PP. 3-66.
 33. Ivanov, V.K., A.F. Tsyb, A.I. Gorsky et al. Leukaemia and thyroid cancer in emergency workers of the Chernobyl accident: estimation of radiation risks (1986-1995). *Radiat. Environ. Biophys.* 36(1): 9-16 (1997).
 34. Ivanov, V.K., A.I. Gorski, A.F. Tsyb et al. Radiation risks of leukemia among Russian emergency workers, 1986-1997. in: International Symposium on Radiation and Homeostasis, Kyoto, Japan, 13-16 July 2001. (In press).
 35. Romanenko A.Ye. et al. Main results of pilot study of leukaemia and related diseases in participants of mitigation consequences of Chernobyl catastrophe in Ukraine. In: International Conference "Fifteen Years after the Chornobyl Accident. Lessons Learned". Kiev, 2001. Chornobylinterinform. P. 3-69. (In Russian).
 36. Dyagil I.S. et al. Experience of international haematological review in Ukraine. In: Ukrainian journal of haematology and transfusiology, 2001, N1, PP. 15-18 (in Russian).
 37. Ledoshchuk B.A. et al. Results of the 10-years study of leukemia in Chernobyl accident clean-up workers in Ukraine. In: Risk Analysis: Facing the New Millenium. Proceedings of SRA-Europe 9th Annual Conference/ Rotterdam, the Netherlands. October 10-13, 1999. P.833-836.
 38. Ledoshchuk B.A., Gudzenko N.A. Leukemia, lymphoma and related disorders in clean-up workers of the Chernobyl catastrophe consequences: developing of our understanding. In: Foresight and Precaution. Proceedings of ESREL 2000, SARS and SRA-Europe Annual Conference. Edinburgh, Scotland, UK. May 14-17, 2000. P. 765-767.
 39. Ledoshchuk B.A., Gudzenko N.A. Haemoblastosis in liquidators: 15 years after Chernobyl catastrophe. Main results and perspective. In: International Conference "Fifteen Years after the Chornobyl Accident. Lessons Learned". Kiev, 2001. Chornobylinterinform. P. 3-10.
 40. Ivanov, E.P. et al. Chernobyl registry and hematological surveillance of Belarus liquidators. p. 171-192 in: Sixth Symposium on Chernobyl-Related Health Effects, Tokyo, 10-11 December 1997.
 41. Tronko N.D., Bogdanova T.I. Thyroid cancer in children of the Ukraine (consequences of Chernobyl catastrophe). Kiev: Chornobylinterinform, 1997. 198 p. (in Russian).
 42. Bebeshko V.G. et al. Evaluation of blood performing system in Children, evacuated from Prypyat city and inhabited on contaminated with radionuclides territories after Chernobyl accident. In: International Journal of Radiation Medicine, special issue, 2001, Vol. 3, N2, P. 159.
 43. Bebeshko V.G. et al. Influence of negative factors of environment on development of leukaemia and lymphoma in children inhabited in Kiev region before and after Chernobyl accident. In: Ukrainian Journal of haematology and transfusiology, 2001, N2, PP. 17-25 (in Russian).
 44. G.Moroz. Childhood leukaemia in Kyiv city and Kyiv region after Chernobyl -17 year follow up // *British Journal of Haematology.* - 1998. -Vol.102, 11. - P.19.
 45. Moroz G., Drozdova V., Kireyeva S. Analysis of prognostic factors of acute leukemia after Chernobyl in children of Kyiv // *Annals of Hematology.* - 1999.- Suppl. II to Vol. 78. - P.40.
 46. Moroz G., Drozdova V. Risk of acute childhood leukaemia in Ukraine after the Chernobyl reactor accident // *The Hematology Journal.* - 2000.- Vol. 1, Suppl. 1. - P. 3.
 47. Andrey G Noshchenko, Kirsten B Moysich, Alexandra Bondar, Pavlo V Zamostyan, Vera D Drosdova and Arthur M Michalek. Patterns of acute leukaemia occurrence among children in the Chernobyl region. / *International Journal of Epidemiology* 2001; 30: 125-129.
 48. Boice, J.D. Jr. and L.E. Holm. Radiation risk estimates for leukaemia and thyroid cancer among Russian

emergency workers at Chernobyl. Letter to the editor. *Radiat. Environ. Biophys.* 36: 213-214 (1997).

Intelligence and Brain Damage in Children Acutely Irradiated in Utero As a Result of the Chernobyl Accident

Angelina I. NYAGU, Konstantin N. LOGANOVSKY, Tatiana K. LOGANOVSKAJA,
Viktor S. REPIN* and Stanislav Yu. NECHAEV*

*Department of Neurology, Institute for Clinical Radiology, Research Centre for Radiation Medicine of
Academy of Medical Sciences of Ukraine, WHO Collaborative Centre: nyagu@vent.kiev.ua*

**Department of Dosimetry and Radiation Hygiene, Institute for Epidemiology and Prophylaxis of Radiation
Injuries, Research Centre for Radiation Medicine of Academy of Medical Sciences of Ukraine, WHO
Collaborative Centre. 53 Melnikov Street, Kiev, 04050, Ukraine*

Abstract

The objective of the study was psychometric, neurophysiological and neuropsychiatric characterisation of acutely prenatally irradiated children. 100 randomly selected children who were in utero (born between April 26th, 1986 and February 26th, 1987) at the time of the Chernobyl accident and their mothers evacuated to Kiev as well as 100 classmates of the children were examined by the Wechsler Intelligence Scale for Children (WISC), electroencephalography (EEG) and clinical methods at the age of 10–12 years old. Foetal doses in the acutely exposed group were 11–92 mSv, in the comparison group — 0–3 mSv; foetal thyroid doses — 0.2–2 Gy and 0–0.04 Gy, respectively. The acutely exposed group showed a lower mean verbal IQ than in the comparison group (105.3±13.1 vs. 118.1±13; $p < .001$) and a lower mean full scale IQ (112.1±15.4 vs. 120.9±11.5; $p < .001$). In addition the followings were observed in the acutely exposed group; WISC performance/verbal discrepancies with verbal decrements; a higher frequency of low-voltage and epileptiform EEG-patterns and left hemisphere lateralised dysfunction; an increase ($p < .001$) of δ - and β -power and a decrease ($p < .001$) of θ - and α -power; an increased frequency of paroxysmal and organic mental disorders, somatoform autonomic dysfunction, disorders of psychological development, and behavioural and emotional disorders. Cerebral dysfunction was etiologically heterogeneous. This study suggests that prenatal irradiation at a thyroid foetal dose range of 0.2–2 Gy and a foetal dose of 11–92 mSv can result in detectable brain damage.

Background

Considerable strides have been made in the recent past in the knowledge and understanding of the effects of ionising radiation on the developing brain. A dose of 10 mSv is postulated to cause a reduction in IQ (intellectual quotient) of 0.3 [1]. The developing human brain is substantially more susceptible to teratogenic insults than most other embryonic and foetal structures [2].

The brain develops in 4 overlapping stages. The main developmental event of the first stage (0–7 weeks after fertilisation) is the commencement of neuronal mitosis during which the brain produces two to three times the full adult complement of neurones [3]. Impaired cell division presumably gives rise to fewer neurones and may result in dysraphic abnormalities (at 3–4 weeks), cerebellar agenesis (at 4–10 weeks) and small head size (at 3–12 weeks) [2].

The second stage (8–15 weeks) is the first critical period of cerebrogenesis and corresponds to the most rapid proliferation of neuronal elements and substantial migration of neurones to the neocortex from their proliferative zones near the cerebral ventricles [4–6]. Disturbances in cell migration may result in ectopic grey matter and dysplasia [2]. Learning disorders and some form of mental retardation may arise from abnormal migration [3].

The third stage (16–25 weeks) is the second critical period of cerebrogenesis. This stage corresponds to the progress of neuronal differentiation and synaptogenesis, and the beginning of the formation of brain architecture [2]. The most striking neurobiological event at this stage is programmed cell death or apoptosis, when more than 50% of migrated neurones are eliminated prior to birth [3]. The recently proposed neurodevelopmental theory of the genesis of schizophrenia shows that the second trimester of pregnancy is critical, and disturbed neuronal apoptosis is considered as a key neurobiological abnormality leading to schizophrenia [7]. Programmed cell death, essential to the development of the normal brain and its adnexa, could be accelerated or otherwise altered by ionising radiation [2].

The fourth stage (26+ weeks) indicates cell differentiation, progressive growth of dendrites and axons, further formation of synapses and cerebral cytoarchitecture [2,8]. Synaptic development is also characterised by distinct waves of overproduction and elimination [3]. Possible damage of thalamocortical innervation (at 24–33 weeks) is indicated by abnormal cortical differentiation, and by involution of subpial granular layer (at 24–38 weeks) — so-called marginal heterotopias [2].

Over the years, the Atomic Bomb Casualty Commission (ABCC) and its successor, the Radiation Effects Research Foundation (RERF), have established several overlapping samples of individuals prenatally exposed to the atomic bombing of Hiroshima and Nagasaki. According to the DS86 system of dosimetry there are 1,544 clinical samples of prenatally exposed survivors from a sample of 1,599 (including 509 nonexposed persons) derived from the T65DR system of dosimetry. Severe mental retardation has been clinically diagnosed in 30 (5 in nonexposed) children [2, 9]. Analysis of the Koga intelligence test scores obtained in 1955 on the prenatally exposed survivors has revealed a progressive shift downwards in the distribution of these scores with increasing exposure. There is an apparent dose-related reduction in mean IQ for the groups irradiated in the periods 8–15 weeks and 16–25 weeks after fertilisation. This effect is still apparent when the seriously retarded persons are excluded from the analysed population [10].

Data on the incidence of severe mental retardation as well as variation in intelligence quotient (IQ) and school performance show significant effects on those survivors exposed 8–15 and 16–25 weeks after ovulation. Studies of seizures also exhibit a radiation effect in survivors exposed 8–15 weeks after ovulation. Magnetic resonance imaging of the brains of some mentally retarded survivors has revealed a large region of abnormally situated grey matter, suggesting an abnormality in neuronal migration. Radiation-related small head size is related to a generalised growth retardation [11]. A recent reanalysis of the dosimetry data indicated that the dose threshold for the development of mental retardation after intrauterine irradiation at gestation terms of 8–15 weeks is 0.06–0.31 Gy. At gestation term of 16–25 weeks, it is 0.28 Gy [12].

The question of the increased lifetime prevalence of schizophrenia in survivors prenatally exposed to atomic bomb radiation is still open to discussion [13]. Among 1,867 prenatally exposed individuals, 18 subjects (0.96%) had developed schizophrenia later in life. The prevalence was significantly higher in the people exposed in the second trimester of pregnancy than in those exposed in the third trimester. The closer they had been to the hypocentre, the higher was the prevalence. No statistically significant linear relationship was found [14].

Brain damage due to prenatal exposure was recognised by World Health Organisation (WHO) as a priority area in the assessment of the health consequences of the Chernobyl accident. Such acknowledgement led to the establishment of the WHO Pilot Project «Brain Damage in Utero» of the International Programme on the Health Effects of the Chernobyl Accident (IPHECA). Analysis of the results in three countries (Belarus, Russian and Ukraine) has shown the following:

- a) incidence of mild mental retardation in prenatally irradiated children is higher when compared with the control group;
- b) an upward trend was detected in cases of behavioural disorders and in changes in the emotional problems in children exposed *in utero*;
- c) incidence of borderline nervous and psychological disorders in the parents of prenatally irradiated

children is higher than that of controls.

On the basis of the investigations it was impossible to arrive at a final conclusion on the relationship between an increase in the number of mentally retarded children and exposure to ionising radiation due to the Chernobyl accident because of an absence of dosimetric support of the studies [15–17].

Recently some related studies have been published. Children irradiated *in utero*, living on the radioactively contaminated areas in Russian Federation (Tula Region, ^{137}Cs deposition density 185–555 $\text{kBq}\cdot\text{m}^{-2}$) at the age of 1–7 years had the highest indices of mental morbidity and were more likely to display borderline intelligence and mental retardation. This morbidity was linked by the authors to radiation [18].

In Belarussian prenatally irradiated children, especially those exposed in 8–15 weeks, there were revealed more functional and organic disorders of central nervous system (CNS), borderline intelligence quotients (IQ) and abnormal EEG that were firstly linked to both radiation and psychosocial factors [19]. However, further these mental disorders among Belarussian children irradiated *in utero* were recognised as a result of sociodemographic and socio-cultural factors only [20]. Among these children there were revealed an increased prevalence of specific developmental speech-language and emotional disorders, as well as a lower mean full scale IQ and more cases of borderline IQ, which did not show the existence of a dose-effect relationships. No statistically significant distinctions in average IQ were found between the different subgroups of children in relation to the gestational age at the time of the Chernobyl accident. The authors attributed these disorders exclusively to unfavourable social-psychological and social-cultural factors [21]. At the same time, the same authors concerning the same children recently reported that average IQ for the subgroup of highly exposed children (thyroid doses more than 1 Gy) was lower in comparison with average IQ for the whole exposed group (85.7 ± 6.4 vs 89.6 ± 10.2 at the age of 6–7 years, $P=.014$; 89.1 ± 7.1 vs 94.3 ± 10.4 at age 10–12 years, $P=.003$) [22].

In contrast to the results of the WHO Pilot Project «Brain Damage in Utero» and another relevant studies, there are three recently published papers [23–25] where the authors concluded that 1) the mental and physical health of evacuee and non-evacuee children is similar and quite normal [23]; 2) the evacuee children (including irradiated *in utero*) were not different from their classmates based on data derived from objective and on the majority of the subjective measures used to assess attention, memory, intelligence and school performance [25]; 3) more evacuee mothers subjectively reported memory problems [25] and somatic symptoms [23, 24] in their children than classmates' mothers; 4) greater Chernobyl-focused anxiety is associated with slightly poorer performance on measures of attention [25]; 5) the most important risk factors were maternal somatization and Chernobyl-related stress [24]. However, as noted the authors, no dosimetric data were available, and there were no normative data in Ukraine for the measures used in the study [24, 25].

In the frame of the WHO Pilot Project «Brain Damage in Utero» we have previously revealed a significant increase of borderline and low range IQ, emotional and behavioural disorders, a decrease in high ($\text{IQ}>110$), as well as statistically significant higher prevalence of mental retardation ($\text{IQ}<70$) in Ukrainian prenatally irradiated children compared to the controls: 21 (3.9%) vs. 12 (1.6%) correspondingly ($\chi^2=6.27$; $\text{df}=1$; $P<.05$) [16, 26]. Besides, we found that the thyroid-stimulating hormone (TSH) level grows with foetal thyroid dose increase with the 0.3 Sv threshold [27]. The radiation-induced malfunction of the thyroid-pituitary system was proposed as one important biological mechanism in the genesis of mental disorders in the prenatally irradiated children [16, 26]. It was hypothesised that the cerebral basis of mental disorders in the prenatally irradiated children is the malfunction of the left hemisphere limbic-reticular structures, particularly in those exposed at 16–25 weeks of gestation, which obviously reflects developmental abnormalities of brain structure and function as a result of interaction of prenatal and post-natal factors, including possible radiation effects on the developing brain. It was also proposed that the left hemisphere is more vulnerable to prenatal irradiation than the right [28].

Thus, in the majority of studies an increased prevalence of cognitive, emotional and behavioural impairments have been revealed in prenatally children exposed as a result of the Chernobyl accident. A point

at issue remains the contribution of prenatal irradiation of a foetus and, especially, of the foetal thyroid gland to the genesis of brain damage in these children.

The objectives of the study was the psychometric, neurophysiological and neuropsychiatric (according to the International Classification of Disease, 10th Revision (ICD-10) criteria) characterisation of acutely prenatally irradiated children. This study involves acutely prenatally exposed children — born between April 26th, 1986 and February 26th 1987 from pregnant women at the time of the accident who had been evacuated from the 30-kilometer zone surrounding the Chernobyl NPP to Kiev — and their classmates. This sample seems to be optimal for examination of possible distinguished effects of exposure in different periods of cerebrogenesis.

Subjects and Methods

Design and Sample

The design was a cross-sectional assessment of children who were *in utero* (born between April 26th, 1986 and February 26th, 1987) at the time of the Chernobyl accident (April 26th, 1986) and their mothers who have been evacuated to Kiev. This group was acutely prenatally exposed to both radiation and non-radiation factors at the time of explosion, being at the Chernobyl exclusion zone and evacuation route. Inhabitants of the town of Pripyat (n=49,360) and railway station Yanov (n=254) were evacuated on April 27th, 1986. Residents of the 10-kilometre zone surrounding of the Chernobyl NPP (n≈10,000) were on May 2nd — 3rd, 1986. Since May 4th, 1986 stepwise evacuation of population of the 30-kilometer zone surrounding of the Chernobyl NPP was began. To the middle of August, 1986 there were evacuated 90,784 people from 81 settlements of Ukraine [29].

Obviously, these acutely prenatally exposed children-evacuees from Pripjat towards Kiev are the most adequate subcohort for comparison with the Japanese cohort prenatally exposed to the atomic bombs in Hiroshima and Nagasaki in view of 1) acute prenatal exposure, and 2) as much as possible urbanised sample.

The WHO Pilot Project «Brain Damage in Utero» International Advisory Board estimated the number of births to be identified in the interval between April 26th, 1986 and February 26th, 1987 in the Ukrainian radioactively contaminated areas (including the Chernobyl exclusion zone — 30-kilometer zone surrounding the Chernobyl NPP) as 1,400. However, when in 1993–1994 we could indeed identify 1,021 (73%) of these children, only 272 (27%) of them were evacuees from the Chernobyl exclusion zone. The reduced group of the identified prenatally irradiated children could be explained by both medical and spontaneous abortions (miscarriages) and migration. In the course of the WHO Pilot Project «Brain Damage in Utero» in Ukraine we have examined 544 (53%) prenatally irradiated children, only 115 (21%) of which were evacuees from the Chernobyl exclusion zone. The reduced number of the examined children irradiated *in utero* could be explained by: 1) migration and «dispersion» across Ukraine and other countries, 2) incorrect registration as prenatally irradiated children, 3) local organisational problems, and 4) refusals to be examined.

In 1997–1998, according to the database of the National Register of Ukraine, we identified the official cohort of prenatally irradiated children in Ukraine that consisted of 733 children, including 278 (38%) children born from mothers who had been evacuated from the Chernobyl exclusion zone in 1986. 145 (52%) of them live in Kiev, 133 (48%) — in 26 regions of Ukraine (3–10 children per region). Besides, we have identified additional 69 prenatally irradiated children-evacuees living in Kiev according to the data of the Specialised Clinical and Epidemiological Register (SCER) of the Research Centre for Radiation Medicine (RCRM) of Academy of Medical Sciences (AMS) of Ukraine. Thus, we have identified 347 prenatally irradiated children-evacuees including 214 (62%) living in Kiev. Among the latest there is the subcohort consisting of 182 (85%) children-evacuees from the town of Pripjat.

From the subcohort of 182 prenatally irradiated children-evacuees from the town of Pripjat living in Kiev we randomly selected 100 (55%) children for the study (acutely exposed group). The comparison group consisted of 100 gender- and age-matched children selected from the classrooms of the children of the

acutely exposed group. Children of both groups were officially included to the SCER of the RCRM of AMS of Ukraine and were profoundly medically examined by general paediatrist, paediatrist-psychoneurologist, paediatrist-endocrinologist, paediatrist-Ear-Nose-Throat (ENT), paediatrist-ophtalmologist, paediatrist-cardiologist, paediatrist-haematologists, paediatrist-pulmonologists, paediatrist-gastroenterologists, paediatrist-surgeon, paediatrist-gynecologist (for girls), and genetics using general and biochemical blood tests, immunological tests, urine tests, coprogram, thyroid and visceral ultrasonography, electrocardiogram (ECG), electroencephalogram (EEG), rheoencephalogram (RhEG) as well as fibrogastoscopy, cardiac ultrasonography, and magnetoresonance imaging (MRI) for diagnostic reasons. These examinations have been carried out at the Children Department of the Out-Patients' Clinic of the Radiation Register of the RCRM of AMS of Ukraine.

It should be emphasised that neuropsychiatric assessments presented here are based on neurological and psychiatric examinations, psychometry of both children and their mothers, and conventional and computerised EEG, which have been carried out by us and associates at the Neurology Department of the RCRM of AMS of Ukraine. The assessments took place in 1997–1999 when the children were 10–12 years old.

Estimation of Prenatal Age at Exposure

The most important single factor in determining the nature of the insult to the developing brain from ionising radiation exposure is gestational age. There are possible errors in the estimation of prenatal age at exposure. Postovulatory age is usually estimated from the onset of the last menstrual period, and adjustment is then made for the differences between that date and the probable date of fertilisation (usually taken to be 2 weeks later). Women with irregular menstrual cycles or who miss a menstrual period could erroneously identify the onset of their last cycle [2].

In order to avoid the aforementioned uncertainties concerning the estimation of prenatal age at the time of the Chernobyl accident we used the adapted formulas offered for estimation of prenatal age at atomic bombing in Hiroshima and Nagasaki [30]:

$$\text{Days of pregnancy } (Y) = 280 - (\text{date of birth} - \text{April } 26^{\text{th}}, 1986),$$

where the day of birth was obtained by interview with the mothers of the children and the mean duration of pregnancy is taken to be 280 days.

Gestational weeks after fertilisation at the time of the accident were calculated by the following equation:

$$\text{Gestational weeks } (G) = (Y - 14 \text{ days}) / 7 \text{ days},$$

where G was taken to be zero if $G < 0$.

Dosimetry

Individual reconstruction of foetal doses, foetal thyroid doses and foetal doses on the brain has been carried out in the Department of Dosimetry and Radiation Hygiene (Chief — Prof. I.A. Likhtariev) of the RCRM of AMS of Ukraine. It should be stressed that individual reconstruction has been carried out for all children of both the acutely exposed group and the comparison group because the residents in Kiev were also exposed to the Chernobyl accident fall-outs although significantly less than evacuees.

The main sources of irradiation of pregnant women were as follows: 1) external γ -irradiation of the whole body; 2) irradiation of thyroid by radioactive iodine isotopes; 3) internal irradiation by inhaled radionuclides; 4) internal irradiation by radioactively contaminated food. The dose depended on the settlement, the route of evacuation, and the places of intermediate and final evacuation. The estimation of individual doses was carried out by the methods of retrospective dosimetry that were elaborated on the base of measurements of the dynamic of exposure dose rate (EDR) at the settlements, analysis of 30,000 «route sheets» (information on clear address at the settlement, the date and the time of evacuation, the route of

evacuation, the place of intermediate and final evacuation), direct measurements of radioactive iodine content in 10,000 evacuees, ^{137}Cs deposition density at the place of intermediate evacuation [31, 32].

Reconstruction of foetal doses was based on reconstruction of doses of pregnant women. For estimation of foetal dose due to external irradiation the screening properties of mother's body were taken into account, and for estimation of thyroid foetal dose — mother's thyroid dose. Shield factor of buildings in towns was taken to be 10, in rural settlements — 3. Behavioural factor (time fraction outside houses) for pregnant women was taken to be 0.4.

Summarised dose on the whole foetus was taken to be equal to the dose of pregnant woman. The tissue-equivalent human phantom was exposed to real Chernobyl fall-outs in order to calculate the dose on the foetal human brain. At the places of foetal organs in the phantom LiF detectors with sensitivity 0.01 mSv were disposed. The transfer coefficient from EDR to equivalent dose on the foetal brain ($K_{\text{dbrain}} = 0.57 \cdot 10^{-2}$ mSv per 1 mR) was obtained considering the screening effect of foetal head by mother's pelvic bones, which does not depend on the prenatal age [32]. Finally, the dose on the foetal brain was calculated as the summarised dose of mother's external irradiation multiplied by K_{dbrain} .

In the earliest period after the Chernobyl accident (April 26th — May, 1986) internal irradiation by radioactive iodine had the most impact on the absorbed dose forming in population. Radioiodine from pregnant woman transfers to foetus quite rapidly. The rate of transfer increases in hundreds times in proportion to the term of pregnancy. Foetal thyroid begins its functioning at about the 8–12 weeks when it absorbs 50–70% of the whole radioiodine transferred to foetus. The radioiodine transfer rate to foetal thyroid is maximal at about the 20–25 weeks [33]. Consequently, foetal thyroid doses were reconstructed since the 8th week after fertilisation.

Foetal thyroid doses were calculated on the base of direct measurements of radioiodine contents in mothers' thyroid, taking into account age and other correction factors; ratio of radioactive iodine isotopes release from the reactor, wind speed and direction. The mean standardised thyroid dose of the adult population of Pripjat was taken to be 0.605 Gy (standard error 7%). Protective effect of stable iodine was taken to be 0.75. At present there are no officially adapted model for calculation of foetal thyroid dose that can be by 1 to 10 times larger than mother's thyroid dose [31, 32]. Assuming that the coefficient of transplacental transfer of iodine is 1 and iodine concentrations in maternal and foetal structures are equal, maternal and foetal thyroid doses were taken to be equal and not dependant on the prenatal age.

Intelligence assessment

The intellectual ability of children was assessed by the adapted and normalised version for the Ukrainian children of the WISC [34], which was carried out by Prof. Yu.Z. Gilbukh and colleagues from the Research Institute of Psychology of Academy of Pedagogic Sciences of Ukraine [35]. The child's performance was summarised in three composite scores, the verbal, performance and full scale IQs, which provide estimates of the individual's intellectual abilities.

Testing procedures were performed at standard conditions at the Neurology Department of the SCRM of AMS of Ukraine in a quite, adequately lit, well-ventilated room without an accompanying adult, seating and materials arrangement corresponded to recommendations by [34, 35] together with co-operative relationships between the child and the examiner. The entire test was administered in a single session.

Following subtests of the WISC were used: verbal scale — information, vocabulary, similarities, and digit span; performance scale — picture completion, block design, object assembly, and coding. We used eight subtests only of the WISC, as manuals permit it, to predict a possible fatigue of children due to following testing and examinations. The sum of subtest scaled scores on the affected scale was prorated to obtain the verbal and performance score that was used to derive the IQ score. To prorate the child's score on four verbal and four performance subtests we multiplied the sum of the four scaled scores by 1.25. The sums

of verbal and performance subtest scaled scores were prorated separately and the resulting verbal and performance scores were summed to yield the full scale IQ score. Scaled score equivalents of raw scores, standardised to age, and IQ equivalents of sums of scaled scores for verbal, performance, and full scales were obtained from the norms and conversion tables for Ukrainian children [35].

Cerebral electrical activity assessment

Quantitative electroencephalography (QEEG) is a set of non-invasive tools that are capable of quantitatively assessing activity of the brain with sensitivity and temporal resolution superior to those of any other imaging methods. The EEG power spectrum is quite stable and characteristic for healthy human beings. At the same time many brain dysfunctions, including environmentally induced ones, can be distinguished by QEEG with specificity of about 95% and sensitivity of 60–95% [36]. The level of sensitivity and specificity of QEEG for brain injury (which is possible to expect in acutely prenatally irradiated children) meets the standards of sensitivity and specificity maintained for MRI, sonograms, blood analysis, and other common clinical diagnostic measures [37]. Thus, QEEG is one of the most adequate diagnostic technologies for assessment of radiation effects on the brain.

Neurophysiological investigations were carried out in the neurophysiological laboratory of the Department of Neurology, RCRM of AMS of Ukraine in the first half of the day during the passive awake state of a child. The children were nonmedicated for 3 and more days.

Brain electrical activity was recorded monopolarly using the International 10–20 System on 19 channels, referenced to linked ears on a brain potential analyser «Brain Surveyor», SAICO, Italy. EEG were registered at 1) passive awakeness, eyes closed — 1 min, 2) passive awakeness, eyes open — 30 s, 3) hyperventilation, eyes closed — 3 min, and 4) passive awakeness after hyperventilation, eyes closed — 1 min. Spectral analysis of brain electrical activity was conducted. Epochs of analysis consisted of 60 seconds, and analysed frequencies were in the 1–32 Hz range. Estimation and interpretation of conventional and QEEG activity were performed according to Zhirmunskaya's algorithm [38] together with paediatric EEG classic manuals [39–41].

Additional measurements

This paper focuses on intelligence and EEG assessment as well as clinical psychiatric and neurological diagnostic in the children. At the same time the children were also measured by a number of psychological tests, analysis of which we hope to present further. For this paper these measures were used for verification of clinical diagnosis.

Aiming to follow up the children who had been examined before, parents were asked to complete a Russian translation of the Rutter A (2) Behaviour Rating Scale which was used in the WHO Pilot Project «Brain Damage in Utero» in 1993–1994. Parental rating assesses problems associated with health, hyperactivity, and behavioural and emotional disorders [42]. Russian translation of Achenbach's Child Behaviour Checklist (CBCL), the questionnaires for the children and the parents, was also used [43, 44]. Moreover, the Children Questionnaire of Neurosis (CQN) by V.V. Sednev [45], validated and standardised for Ukrainian children, was applied for revealing of depression, asthenia, behavioural disorders, autonomic nervous system dysfunction, sleep disorders, anxiety, and sincerity.

Following the WHO Pilot Project «Brain Damage in Utero», mothers were also asked to complete the General Health Questionnaire (GHQ-28), reflecting the level of her mental adaptation, the level of anxiety and depression, and also social functions [46, 47]. The vocabulary subtest of the Wechsler Adult Intelligence Scales (WAIS) was used to estimate the verbal intelligence of the mother. Moreover, posttraumatic stress disorders (PTSD) in mothers were assessed by the Impact of Events Scale and Arousal Scale of PTSD [48], as well as mother's unmasking depression — by the Self-rating Depression Scale [49].

Finally, mothers were asked for demographic background, family history, educational level of the

family, social and economical status as well as they completed a standardised questionnaire on radiation history. On the base of the Diagnostic and Statistical Manual of Mental Disorders, 4th Edition (DSM-IV) Scale of Stress-Factors [50] we elaborated a standardised questionnaire on stress-factors related to the Chernobyl accident that reflects a severity of *real* stress events (but not affective symptoms or Chernobyl-focused anxiety) following the Chernobyl accident to the birth of the child. For instance, separation with the husband and family during evacuation; absence information about the husband, participating in emergency work at the Chernobyl NPP, and family; consumer problems at the places of evacuation; low level of medical care, etc.

Clinical Psychiatric and Neurological Assessment

The children of both the acutely prenatally exposed and the comparison groups were examined by standardised clinical psychiatric interview and standardised clinical neurological examination at the Department of Neurology, RCRM of AMS of Ukraine. The mental disorders and the diseases of the nervous system were assessed according to the diagnostic criteria of ICD-10 (Chapter V: Mental and Behavioural Disorders & Chapter VI: Diseases of the Nervous System). ICD-10 diagnostic was made on the base of clinical psychiatric and neurological examinations, psychometry, conventional and QEEG, taking into account the results of the profound clinical, laboratory, and instrumental examination at the Children Department of the Out-Patients' Clinic of the Radiation Register of the RCRM of AMS of Ukraine, including MRI of the brain for diagnostic reasons.

Statistical Analysis

Statistical processing included descriptive statistics, *t* test, Chi-square tests, relative risk (RR) assessment, correlation and multiple regression analyses [51]. The paired *t* test was used to analyse data when a pair of measurements was obtained on each individual [52]. The Bonferroni correction was used when multiple statistical test were performed [53]. Statistical analysis was performed using STATISTICA 5.0 and MS EXCEL 97 software.

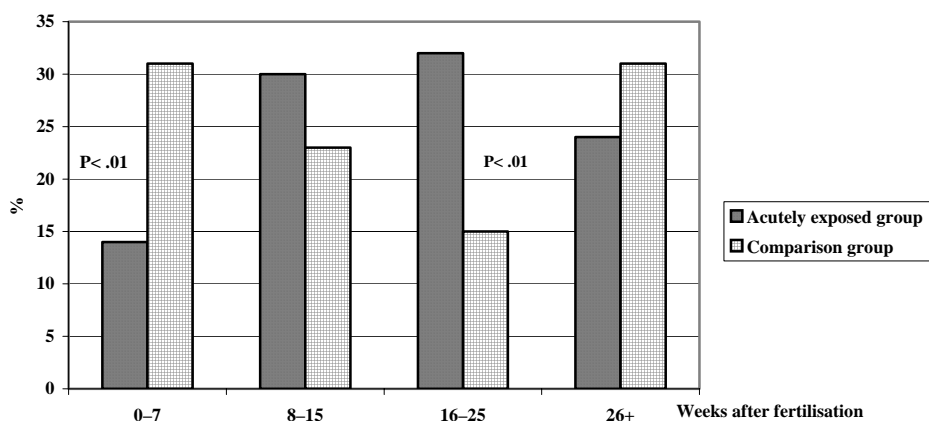

Figure 1. Distribution of children by prenatal age at the time of explosion (April 26th, 1986)

Results

Descriptive Characteristic

The age ($M \pm SD$) was 11.3 ± 0.4 years for the children from the acutely exposed group and 11.48 ± 0.82 for the classmates; 54% of the evacuee children and 56% of the comparison groups were male.

Distribution of children by prenatal age at the time of the Chernobyl accident is shown in Figure 1. In spite of a randomised procedure of the children selection, a significant reduction is found in the number of the children irradiated at 0–7 weeks after fertilisation in the acutely exposed group in comparison with the classmates (14% vs. 31%; $\chi^2=8.29$; $P<.01$), which could be explained as the result of abortions and/or miscarriages among pregnant women-evacuees. However, it is difficult to explain why there is also a significant reduction of the number of the children from Kiev at 16–25 weeks after fertilisation in comparison with the acutely exposed group (32% vs. 15%; $\chi^2=8.04$; $P<.01$).

Mean, standard deviation, and range of the individual foetal doses (summarised foetal dose of external irradiation, mSv; equivalent dose on the foetal brain, mSv; cumulated thyroid foetal dose (since the 8th weeks after fertilisation), Gy) for the two groups of children are presented in Table 1. It is clear that the children of the two groups correspond to the subgroups of the Japanese sample [2]: prenatally exposed survivors to atomic bomb radiation of the foetal dose category less than 0.01 Gy ($n=1,201$) — to the Ukrainian comparison group, and those of the dose category 0.01–0.09 Gy ($n=322$) — to the Ukrainian acutely exposed group.

Distribution of summarised foetal dose of external irradiation, equivalent dose on the foetal brain, mSv, and cumulated thyroid foetal dose (since the 8th weeks after fertilisation) among the children of the acutely

Table 1. Individual foetal doses.

Dose	Value	Acutely exposed group	<i>t</i> -test	P	Comparison group
Summarised foetal dose of external irradiation, mSv	$M \pm SD$ Range	31.9 ± 14.4 (10.74 – 92.52)	21.31	<.001	1.2 ± 0.5 (0 – 2.67)
Equivalent dose on the foetal brain, mSv	$M \pm SD$ Range	20.7 ± 9.43 (6.98 – 60.12)	21.14	<.001	0.8 ± 0.5 (0 – 2.52)
Cumulated thyroid foetal dose (since the 8 th weeks after fertilisation), Gy	$M \pm SD$ Range	0.66 ± 0.32 (0.22 – 2.04)	17.52	<.001	0.04 ± 0 (0.041)

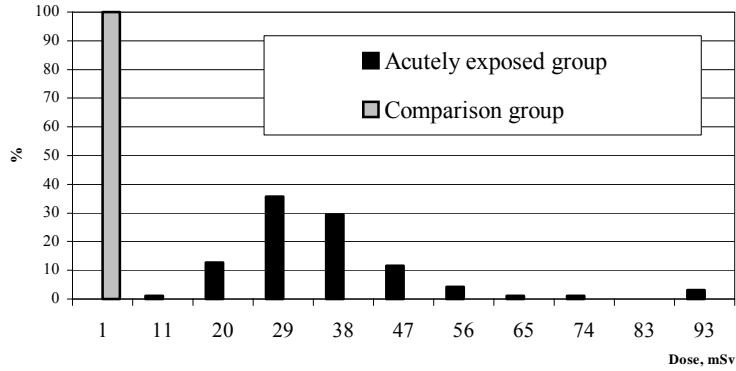

Figure 2. Distribution of summarised foetal dose of external irradiation

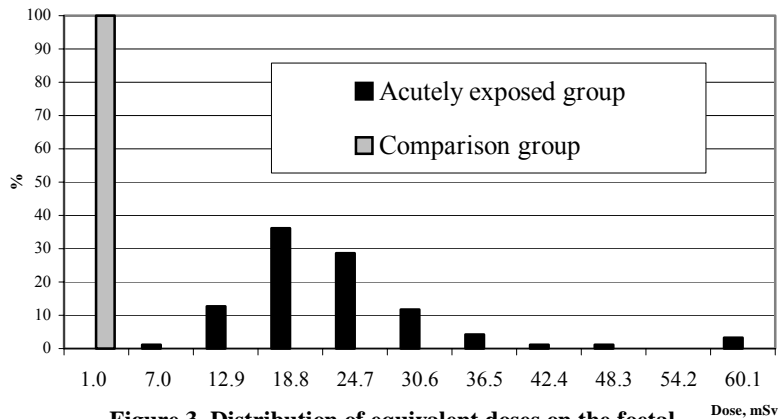

Figure 3. Distribution of equivalent doses on the foetal brain

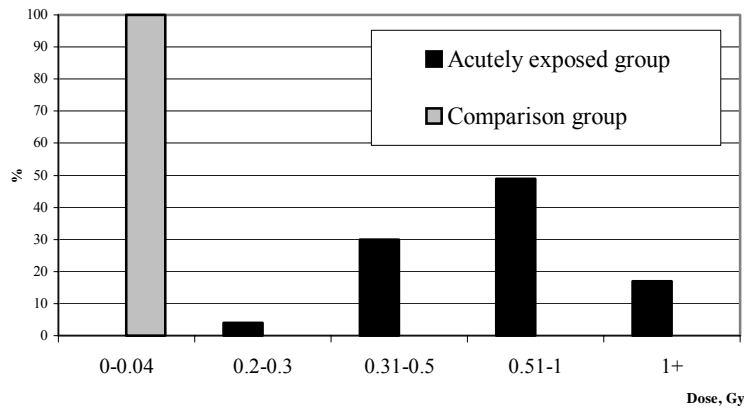

Figure 4. Distribution of foetal thyroid doses

exposed group are shown in Figures 2, 3 and 4, correspondingly. These foetal doses did not differ depending on the prenatal age at the time of the accident.

As seen in Figure 4, radiation exposure to foetal thyroid was quite significant: the permissible dose limit of 0.3 Gy on thyroid [54] was exceeded in 97% of the children of the acutely exposed group, moreover, the foetal thyroid of 17% of them was exposed to 1 Gy and more.

Among the acutely exposed group there were 5% disabled children and their disability was officially recognised to be caused by the consequences of the Chernobyl accident. Except one child with haemophilia, the four another children had neuromental disorders: moderate mental retardation (1), epilepsy (1), and encephalopathy (2). The child with haemophilia attended the school programme at home, and the child with moderate mental retardation was institutionalised into the special boarding school. Moreover, 7% of the

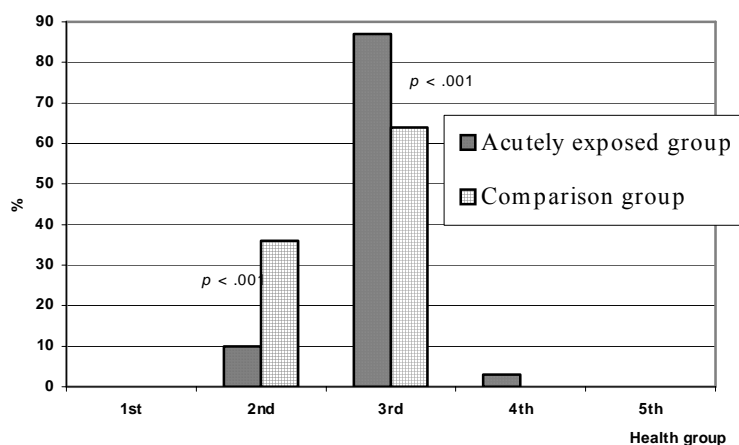

Figure 5. Distribution of children by the health groups

children-evacuee systematically missed school and attended the school programme at home due to different medical reasons except flu (epilepsy, paroxysmal states, behavioural problems, fatigue, headache, lack of concentration, exhaustion, etc). The other children attended public schools.

General health of children in the countries of the former U.S.S.R. is assessed according to the five «health groups»: the 1st health group includes absolutely healthy children; the 2nd — practically healthy children (no complaints, but there are some subclinical symptoms revealed by profound clinical, laboratory and instrumental examination only); the 3rd — children with chronic disease(s) in remission; the 4th — handicapped children with chronic disease(s) in exacerbation demanding active therapeutical intervention and/or institutionalisation; the 5th — handicapped children with severe chronic disease(s) in decompensation stage demanding hospitalisation with absence of learning and self-service. As seen in Figure 5, among the children-evacuees there were significantly less practically healthy children (the 2nd health group) (10% vs. 36%; $\chi^2=19.09$; $P<.001$) and significantly more children with chronic diseases in remission than in classmates (87% vs. 64%; $\chi^2=14.3$; $P<.001$) (the 3rd health group). The 3rd health group in the both groups was predominantly comprised by chronic decompensated tonsillitis and adenoids of the 2nd–3rd severity degree; cardiomyopathy; chronic inflammatory diseases of stomach and intestine at the stage of exacerbation; diffusive thyroid hyperplasia of the 3rd degree, euthrosis (normal thyroid functions); moderate to severe disorders of refraction (hypermetropia, myopia, astigmatism). The conclusion about the health groups is given by the experts of the Children Department of the Out-Patient's Clinic of the Radiation Register of the RCRM of AMS of Ukraine. No single child from the both groups was recognised as absolutely healthy.

The acutely exposed children in comparison with the classmates had more often moderate complications of postnatal period, paroxysmal states, including epileptical, enuresis/encopresis at the age more than 4 years. The evacuated mothers had more often moderate abnormalities and toxicosis of pregnancy (63% vs. 32% correspondingly, $\chi^2=19.27$; $P<.001$).

In the families of the acutely exposed children in comparison with the classmates living conditions were better; families with 2 and more children were more often; 85% of the fathers took part in the Chernobyl accident consequences clean up; 8% of the mothers were disabled and their disability was officially recognised to be caused by the consequences of the Chernobyl accident; the fathers took more alcoholic drinks and tobacco; less number of the parents graduated a university and more — had specialised secondary education.

According to our questionnaire on stress-factors related to the Chernobyl accident, a severity of *real* stress events was dramatically more pronounced in the mothers-evacuees than in the classmate's mothers: 14.9 ± 6.1 vs. 3 ± 5.3 , $t=10.56$, $P<.001$. Although the mothers-Kyievers had not been apparently exposed to *real* Chernobyl-related stress-events (extreme situations) such as evacuation, family separation etc., in

contrast to the mothers-evacuees, the mothers of the both groups have quite significant symptoms of Chernobyl-related PTSD, which were more pronounced in the mothers-evacuees. Mean score of the Impact of Events Scale and Arousal Scale of PTSD in the mothers-evacuees was 18.8 ± 10.6 and the mothers-Kyievers — 14.8 ± 9.9 , $t = 2.02$, $P < .05$.

Mother's unmasking depression estimated by the Self-rating Depression Scale was higher in the mothers-evacuees than in the classmate's mothers: 56.3 ± 10.4 vs. 42 ± 12.5 , $t = 5.22$, $P < .001$.

The mothers-evacuees had also worse than the classmate's mothers mental adaptation and social functions as well as more symptoms of anxiety and depression estimated by the GHQ-28: 9.6 ± 9.6 vs. 4.8 ± 4.9 , $t = 3.71$, $P < .001$.

The verbal intelligence of the mother measured by the vocabulary subtest of the WAIS was lower in the mothers-evacuees than in the mothers-Kyievers: 43.2 ± 10.9 vs. 52.4 ± 8.4 , $t = -5.09$, $P < .001$.

Intellectual ability of children

Distribution of verbal IQ, performance IQ and full scale IQ among the children of the both groups is presented in Table 2. Among the children of the acutely exposed group in comparison with the classmates there were significantly more children with an average verbal IQ of 91–110 (53% vs. 22%; $\chi^2 = 20.5$; $P < .001$) as well as significantly less of children with an high-advanced verbal IQ of 121→ (9% vs. 45%; $\chi^2 = 32.88$; $P < .001$) and an high-advanced full scale IQ of 121→ (27% vs. 55%; $\chi^2 = 16.21$; $P < .001$).

Mean values of all verbal subtests and performance subtest — picture completion of the WISC were significantly lower in the acutely exposed children in comparison with the classmates (Table 3). Although the mean verbal IQ, performance IQ and full scale IQ in children of the both groups were in high range, the acutely exposed group had a significantly lower mean verbal IQ (105.3 ± 13.1 vs. 118.1 ± 13 ; $t = -6.94$; $P < .001$) and mean full scale IQ (112.1 ± 15.4 vs. 120.9 ± 11.5 ; $t = -4.58$; $P < .001$). The mean performance IQ, however, was not significantly different (117.3 ± 18 vs. 119.2 ± 10.2 ; $t = -.92$; $P > .05$).

In spite of a similar performance IQ in the both groups, significant WISC performance/verbal

Table 2. Distribution of verbal IQ, performance IQ and full scale IQ.

IQ range		Acutely exposed group	χ^2	P	Comparison group
Verbal IQ:	<70–80	3	3.05	>.05	0
	81–90	9	3.19	>.05	3
	91–110	53	20.50	<.001	22
	111–120	26	.04	>.05	30
	121→	9	32.88	<.001	45
Performance IQ:	<70–80	3	3.05	>.05	0
	81–90	3	3.05	>.05	0
	91–110	20	.03	>.05	19
	111–120	27	.6	>.05	32
	121→	47	.08	>.05	49
Full scale IQ:	<70–80	3	3.05	>.05	0
	81–90	3	3.05	>.05	0
	91–110	33	3.03	>.05	22
	111–120	34	2.97	>.05	23
	121→	27	16.21	<.001	55

Table 3 WISC subtests, verbal IQ, performance IQ and full scale IQ.

Measure	Acutely exposed group (M±SD)	t-test	P	Comparison group (M±SD)
Verbal scale:				
Information	9.8±2.5	-4.53	<.001	11.4±2.5
Vocabulary	12.3±3.4	-6.84	<.001	15.4±3
Similarities	11.4±2.5	-4.89	<.001	13.2±2.7
Digit span	9.7±2.6	-3.6	<.001	11±2.5
Performance scale:				
Picture completion	14.8±3.4	-3.46	<.001	16.2±2.2
Block design	12.5±3.5	-1.61	>.05	13.2±2.6
Object assembly	10.9±3.3	-.72	>.05	11.2±2.5
Coding	11.7±3.2	2.55	<.05	10.6±2.9
Verbal IQ	105.3±13.1	-6.94	<.001	118.1±13
Performance IQ	117.3±18	-.92	>.05	119.2±10.2
Full scale IQ	112.1±15.4	-4.58	<.001	120.9±11.5

Note: Bonferroni corrected α -level of <.004 was used to assess statistical significance (.05 divided by 11 comparisons within measures of intelligence)

discrepancies (IQ_{p-v} = performance IQ – verbal IQ) with verbal decrements were revealed in the acutely exposed group in comparison with the classmates: 12.1 ± 13.8 (*paired t* = 8.7, $P < .001$) vs. 1.2 ± 11.8 (*paired t* = 1, $P > .05$); $t = 6$; $P < .001$.

WISC performance/verbal discrepancies take on clinical significance at the magnitude more than 25 points [55]. According to this criterion ($IQ_{p-v} > 25$), among the acutely exposed group there were significantly more children with disharmoniously developed intelligence due to verbal decrements than in the comparison group (17% vs. 4%; $\chi^2 = 8.99$; $P < .01$), especially among those irradiated at 16–25 weeks after fertilisation. Among the children irradiated at 16–25 weeks after fertilisation (from acutely exposed group) there were 9 children with $IQ_{p-v} > 25$ out of all 17 (more than $1/2$).

In Table 4 intellectual development of children of both groups corresponding to different periods of cerebrogenesis at exposure is presented. There is a tendency towards a deterioration of full scale IQ and verbal IQ, as well as an increasing of intellectual disharmony (IQ_{p-v}) in children of the acutely exposed group who were exposed at 16–25 weeks after fertilisation. Among those irradiated at 16–25 weeks, the full scale IQ and verbal IQ were the lowest in the acutely exposed.

There were 155 children (86 in the acutely exposed group and 69 in the classmates) who were at the 8th and more weeks after fertilisation at the time of the accident. For 154 (98%) of these children the foetal thyroid dose was reconstructed. IQs of the children in proportion to the foetal thyroid dose is presented in Table 5 and Figure 6. All classmates and 4 children from the acutely exposed group had the prenatal thyroid dose in the range of 0.04–0.3 Gy. It should be noted that the dose of 0.3 Gy on thyroid was the dose limit for the children at the time of the Chernobyl accident [54]. As it is shown in Table 5 and Figure 6, full scale IQ and, especially verbal IQ, were reduced in dependence to the foetal thyroid dose. Performance IQ was slightly reduced above the foetal thyroid dose of >1 Gy only.

According to the results of regression analysis, the children's intelligence is etiologically heterogeneous (Table 6). Higher educational, intellectual, and economical levels of a family, as well as older parents at the time of childbirth (at the examined age ranges 18–35 years for the mothers and 19–42 — for the fathers) are the contributors towards a higher child intelligence. Higher doses of prenatal irradiation, especially foetal thyroid dose, more severe stressogenic events and additional mother's hazards in the prenatal period, worse mother's mental health, as well as childbirth problems are the contributors towards a lower child intelligence.

Foetal thyroid dose seems to be the main predictor of verbal intelligence deterioration (regression coefficient = -0.34 – (-0.39) ; $P < .001$) and WISC performance/verbal discrepancies with verbal decrements

Table 4. Intellectual development of children corresponding to different periods of cerebrogenesis at exposure.

Age in weeks after fertilisation	Acutely exposed group	t-test	P	Comparison group
Total				
Subjects	100			100
Full IQ (M±SD)	112.3±15.4	-4.58	<.001	120.9±11.5
Verbal IQ (M±SD)	105.3±13.1	-6.94	<.001	118.1±13
Performance IQ (M±SD)	117.3±18	-.92	>.05	119.2±10.2
Intellectual disharmony IQ _{P,V} (M±SD)	12.1±13.8	6	<.001	1.2±11.8
<i>paired t</i>	8.7			<i>I</i>
P	<.001			>.05
0-7				
Subjects	14			31
Full IQ (M±SD)	110±14.7	-2.73	<.01	122.2±11.9
Verbal IQ (M±SD)	103.9±15.3	-3.26	<.01	119.4±13.5
Performance IQ (M±SD)	115±14.6	-1.47	>.05	121.4±10.7
Intellectual disharmony IQ _{P,V} (M±SD)	11.1±12.8	2.28	<.05	2±11.4
<i>paired t</i>	3.3			<i>I</i>
P	<.001			>.05
8-15				
Subjects	30			26
Full IQ (M±SD)	113.1±10.9	-1.37	>.05	117.6±12.5
Verbal IQ (M±SD)	106.3±10.5	-2.59	<.01	114.9±13
Performance IQ (M±SD)	117.9±12	.74	>.05	115.6±10.5
Intellectual disharmony IQ _{P,V} (M±SD)	11.6±10.9	3.29	<.001	.8±12.5
<i>paired t</i>	5.8			.3
P	<.001			>.05
16-25				
Subjects	32			15
Full IQ (M±SD)	109.2±20	-2.28	<.05	120.5±13.5
Verbal IQ (M±SD)	102.7±15.5	-2.88	<.01	117.1±16.2
Performance IQ (M±SD)	114.7±23.3	-.75	>.05	118.3±9.7
Intellectual disharmony IQ _{P,V} (M±SD)	12±14	2.62	<.01	1.3±12.6
<i>paired t</i>	4.8			.4
P	<.001			>.05
26-term				
Subjects	24			31
Full IQ (M±SD)	116±13.1	-2.01	>.05	122.3±9.1
Verbal IQ (M±SD)	108.3±11.2	-3.78	<.001	119.6±10.7
Performance IQ (M±SD)	121.4±18	.3	>.05	120.2±9.4
Intellectual disharmony IQ _{P,V} (M±SD)	13.1±17.6	3	<.01	.6±11.8
<i>paired t</i>	3.7			.3
P	<.001			>.05

Table 5 Full scale IQ, Verbal IQ and Performance IQ at prenatal exposure to different thyroid dose.

Thyroid doetal dose, Gy	Full scale IQ, M±SD	Verbal scale IQ, M±SD	Performance scale IQ, M±SD
0.04-0.3 (n=76)	119.6±10.8	116.6±12.3	118.0±9.5
0.31-0.6 (n=31)	113.3±15.2	106.9±12.1	118.0±17.9
0.61-1.0 (n=33)	113.2±14.9	105.5±12.7	119.3±19.2
1.0+ (n=14)	108.4±18.9	102.3±15.2	112.9±20.7

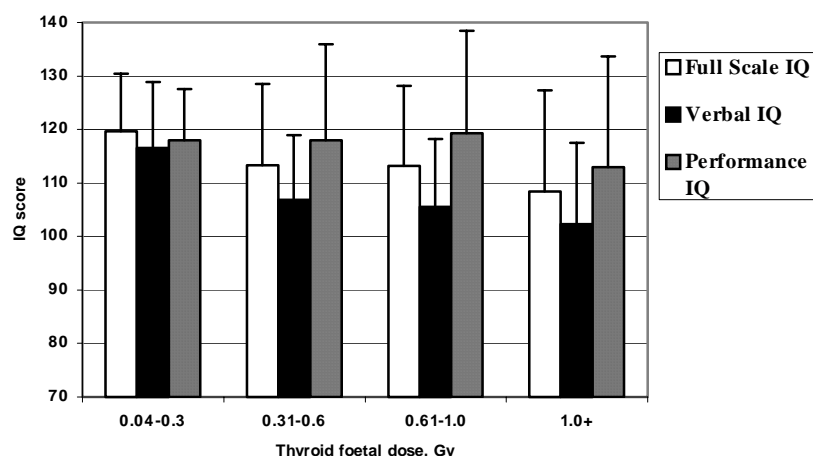

Figure 6. Children intelligence in proportion to the thyroid foetal dose

Table 6 Regression analysis of the predictors of the children's intellectual development.

Predictor	Regression coefficient	F _(df1, df2)	P
<i>Information subtest of WISC</i>			
Mother's intelligence (vocabulary subtest of WAIS)	.21	9.2002 _(1, 198)	.003
Father's age	.20	8.1679 _(1, 198)	.005
Father's educational level	.18	6.6469 _(1, 198)	.01
Mother's age	.18	6.3917 _(1, 198)	.01
Mother's educational level	.14	4.0504 _(1, 198)	.04
<i>Vocabulary subtest of WISC</i>			
Thyroid foetal dose	-.39	25.7159 _(1, 152)	.000001
Mother's intelligence (vocabulary subtest of WAIS)	.36	28.9968 _(1, 198)	.000000
Foetal dose	-.29	18.3566 _(1, 198)	.00003
Dose on the foetal brain	-.29	17.6903 _(1, 198)	.00004
Stress-events after the accident during pregnancy	-.15	4.6808 _(1, 198)	.03
<i>Similarities subtest of WISC</i>			
Thyroid foetal dose	-.24	8.4675 _(1, 152)	.004
Mother's intelligence (vocabulary subtest of WAIS)	.22	9.7155 _(1, 198)	.002
Dose on the foetal brain	-.21	9.0083 _(1, 198)	.003
Foetal dose	-.20	8.5392 _(1, 198)	.004
Stress-events after the accident during pregnancy	-.16	5.1838 _(1, 198)	.02
Economic level of family	.16	5.0957 _(1, 198)	.02
Mother's GHQ-28	-.15	4.6937 _(1, 198)	.03
<i>Digit Span subtest of WISC</i>			
Thyroid foetal dose	-.26	10.5202 _(1, 152)	.001
Mother's intelligence (vocabulary subtest of WAIS)	.24	11.8890 _(1, 198)	.0007
Dose on the foetal brain	-.24	11.5737 _(1, 198)	.0008
Foetal dose	-.23	11.0999 _(1, 198)	.001
Mother's additional hazards during pregnancy	-.15	4.8516 _(1, 198)	.03
Mother's Self-rating Depression Scale (Zung)	-.15	4.3983 _(1, 198)	.04
Father's educational level	.14	4.2379 _(1, 198)	.04
Verbal IQ			
Thyroid foetal dose	-.34	18.7662 _(1, 152)	.00003
Mother's intelligence (vocabulary subtest of WAIS)	.33	24.6009 _(1, 198)	.000002
Dose on the foetal brain	-.28	17.2540 _(1, 198)	.00005
Foetal dose	-.28	17.1946 _(1, 198)	.00005
Father's educational level	.16	4.8868 _(1, 198)	.03
Economic level of family	.15	4.5543 _(1, 198)	.03
Stress-events after the accident during pregnancy	-.14	3.9069 _(1, 198)	.049
Mother's educational level	.14	3.9227 _(1, 198)	.049

(Table 6 continued)

Predictor	Regression coefficient	F _(df1, df2)	P
<i>Picture completion subtest of WISC</i>			
Economic level of family	.26	14.2983 _(1, 198)	.0002
Mother's intelligence (vocabulary subtest of WAIS)	.22	10.0078 _(1, 198)	.002
Dose on the foetal brain	-.19	7.1427 _(1, 198)	.008
Foetal dose	-.18	6.4733 _(1, 198)	.01
Father's age	.17	6.2598 _(1, 198)	.01
Father's educational level	.16	5.0650 _(1, 198)	.02
Mother's GHQ-28	-.16	5.1748 _(1, 198)	.02
Mother's educational level	.15	4.7358 _(1, 198)	.03
Childbirth abnormalities	-.15	4.3178 _(1, 198)	.04
<i>Block design subtest of WISC</i>			
Mother's educational level	.18	6.9333 _(1, 198)	.009
Economic level of family	.17	6.0673 _(1, 198)	.01
Mother's PTSD	-.14	4.1347 _(1, 198)	.04
<i>Object assembly subtest of WISC</i>			
Father's educational level	.18	6.5096 _(1, 198)	.01
Economic level of family	.17	6.1768 _(1, 198)	.01
Mother's intelligence (vocabulary subtest of WAIS)	.14	4.0587 _(1, 198)	.04
<i>Coding subtest of WISC</i>			
Economic level of family	.28	17.1997 _(1, 198)	.00005
Father's educational level	.16	5.3818 _(1, 198)	.02
Mother's GHQ-28	-.14	4.0682 _(1, 198)	.04
Performance IQ			
Economic level of family	.32	22.9500 _(1, 198)	.000003
Mother's intelligence (vocabulary subtest of WAIS)	.23	10.6177 _(1, 198)	.001
Father's educational level	.21	8.7027 _(1, 198)	.004
Mother's educational level	.17	5.8003 _(1, 198)	.02
Disharmony of intellectual development IQ_{p-v}			
Thyroid foetal dose	.31	15.8215 _(1, 152)	.0001
Foetal dose	.23	11.5167 _(1, 198)	.0008
Dose on the foetal brain	.22	10.5278 _(1, 198)	.001
Economic level of family	.19	7.1229 _(1, 198)	.008
Mother's Self-rating Depression Scale (Zung)	.16	4.9322 _(1, 198)	.03
Full scale IQ			
Mother's intelligence (vocabulary subtest of WAIS)	.32	22.3837 _(1, 198)	.000004
Economic level of family	.26	14.4738 _(1, 198)	.0002
Dose on the foetal brain	-.20	8.0329 _(1, 198)	.005
Thyroid foetal dose	-.20	5.8691 _(1, 152)	.02
Father's educational level	.20	7.9749 _(1, 198)	.005
Foetal dose	-.19	7.5897 _(1, 198)	.006
Mother's educational level	.15	4.6695 _(1, 198)	.03
Verbal IQ (children exposed at 16–25 weeks after fertilisation, n=47)			
Thyroid foetal dose	-.39	5.7221 _(1, 45)	.022
Mother's intelligence (vocabulary subtest of WAIS)	.42	5.8961 _(1, 45)	.022
Vocabulary subtest of WISC (children exposed at 16–25 weeks after fertilisation, n=47)			
Thyroid foetal dose	-.51	11.0984 _(1, 45)	.002
Mother's intelligence (vocabulary subtest of WAIS)	.42	6.0628 _(1, 45)	.02

(regression coefficient = .31; P<.001) (Table 6), especially among the children irradiated at 16–25 weeks after fertilisation (Figure 7).

Brain electrical activity of children

The children of the acutely exposed group had significantly less age normal patterns of brain electrical activity in comparison with the classmates (16% vs. 54%, $\chi^2 = 31.74$, $p < .001$) (Table 7). There were four

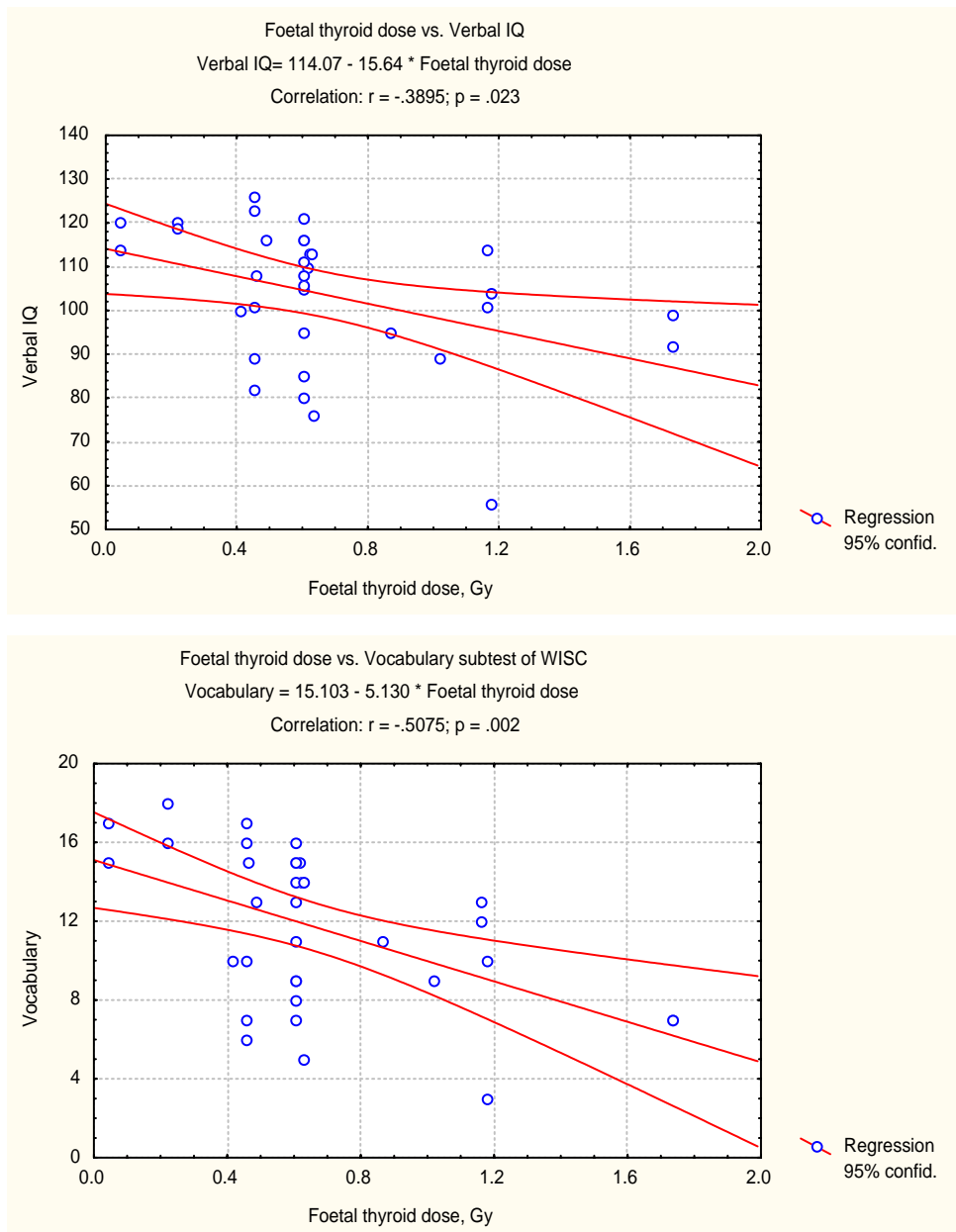

Figure 7. Relationships between Verbal IQ and Vocabulary subtest of WISC vs foetal thyroid dose, in children of the both groups (n=47) exposed at 16–25 weeks after fertilization.

abnormal EEG-patterns in the prenatally irradiated children as follows:

(1) *Low-voltage EEG* (20–25 μV) with excess of slow (δ) and fast (β) activity together with depression of α - and θ -activity with paroxysmal activity shifted to the left fronto-temporal region was one of the most distinguished conventional EEG-pattern in the children of the acutely exposed group (31% vs. 8%, $\chi^2=16.85$, $P<.001$).

(2) *Disorganised slow EEG-pattern* with δ -activity domination characterised by disorganised activity of moderate (40–55 μV) or high (70–80 μV) amplitude with a mainly δ -range slow activity domination and non-regular α -activity where hyperventilation led to bilateral paroxysmal activity discharges, as well as 3) *disorganised EEG-pattern with paroxysmal activity*, similar in general to the one described above, but characterised by generalised paroxysmal discharges and bursts of acute, θ - and δ -waves of high amplitude where the hyperventilation led to the bilateral paroxysmal activity increase, were found equally in the both groups.

(4) *Epileptiformal EEG* with «spike» or «polyspike—wave» complexes in the fronto-temporal region,

Table 7 Conventional EEG-patterns.

EEG-pattern	Acutely exposed group	χ^2	P	Comparison group
Age norm	16	31.74	<.001	54
Organised	0	4.08	<.05	4
Disorganised with predominance of α -activity	10	5.36	<.05	22
Hypersynchronous	6	17.15	<.001	28
Abnormal	84	31.74	<.001	46
Low-voltage	31	16.85	<.001	8
Disorganised slow	16	.16	>.05	14
Disorganised with paroxysmal activity	20	.27	>.05	23
Epileptiformal	17	15.63	<.001	1
Interhemispheric asymmetry	73	24.8	<.001	38
Left hemisphere lateralised dysfunction	37	15.36	<.001	13
Right hemisphere lateralised dysfunction	15	.87	>.05	20
Cross-hemispherical dysfunction	21	11.32	>.001	5

mainly of the left hemisphere, and bilateral paroxysmal activity in the form of δ -waves of very high amplitude (higher than 100 μ V) was another of the most distinguished conventional EEG-pattern among the children of the acutely exposed group (17% vs. 1%, $\chi^2=15.63$, $P<.001$).

Interhemispheric asymmetry of the EEG was revealed significantly more often in the acutely exposed children compared with the classmates (73% vs. 38%, $\chi^2=24.8$, $P<.001$) according to an asymmetry index $>5\%$. An increase of the abnormal or/and a decrease of the normal EEG-signs in one hemisphere in comparison with another were the criteria adopted for the lateralised dysfunction detection (Table 7). Three types of interhemispheric asymmetry were found in the children of the both groups. A *left hemisphere lateralised dysfunction* was characterised by slow and/or epileptiformal activity in the fronto-temporal region together with α -activity depression in the left hemisphere. The left-hemispherical type of EEG-laterality was found more often among the acutely exposed children in comparison with the classmates (37% vs. 13%, $\chi^2=15.36$, $P<.001$). A *right hemisphere lateralised dysfunction* characterised by abnormal activity in the right fronto-temporal region did not differentiate the acutely exposed children from the classmates (15% vs. 20%, $\chi^2=0.87$, $P>.05$). We described a so-called cross-hemispherical dysfunction, which consisted of abnormal activity simultaneously in the fronto-temporal region of one hemisphere and in the parieto-temporal region of another hemisphere. This was found in 21% of the children from the acutely exposed group and 5% of the children from the comparison group ($\chi^2=11.32$, $P<.001$).

According to the spectral EEG-analysis, a significant difference was found between the acutely exposed and the comparison groups (Table 8). The acutely prenatally irradiated children were dramatically distinguished from the classmates by an increase ($P<.001$) of δ - and β -power and a decrease ($P<.001$) of θ - and α -power. However, the pattern of summarised EEG spectral power in the children of the both groups exposed at 0–7 and 26+ weeks after fertilisation was statistically equal (except more δ -power among those acutely exposed at 26+ weeks). The children prenatally acutely exposed at 16–25 weeks of gestation had the most distinguished pattern of summarised EEG spectral power (increased δ - and β - and decreased θ - and α -power), as well as those exposed at 8–15 weeks (increased δ - and decreased θ -power) in comparison with the classmates.

Obviously, children's pattern of cerebral electrical activity is, like intelligence, etiologically heterogeneous. On the basis of correlation and regression analyses we found that the children's EEG-pattern was associated with age, current neuropsychiatric disorder, perinatal pathology, mother's mental health, as well as exposure to the disaster — both to stress and radiation. Foetal dose was the predictor for an increase

Table 8 EEG spectral analysis.

Age in weeks after fertilisation	Acutely exposed group	<i>t</i>	<i>p</i>	Comparison group
<i>Summarised δ (1–4 Hz)-power (%)</i>				
All	47.65±12.54	8.65	<.001	33.59±10.34
0–7	44.99±10.71	3.2	=.001	33.36±12.51
8–15	48.53±15.03	4.25	<.001	32.98±12.34
16–25	49.81±13.10	5.46	<.001	34.05±8.17
26–term	45.05±8.41	4.01	<.001	33.99±10.12
<i>Summarised θ (4–7) –power (%)</i>				
All	15.96±5.61	–8.9	<.001	23.32±6.07
0–7	16.75±6.08	–3.05	<.01	23.12±7.27
8–15	17.76±7.04	–4.99	<.001	26.35±5.84
16–25	14.01±4.05	–8.47	<.001	23±3.79
26–term	15.89±4.68	–3.12	<.01	21.09±6.42
<i>Summarised α (7–12) –power (%)</i>				
All	26.62±10.24	–5.5	<.001	33.50±7.17
0–7	29.79±12.77	–1.07	>.05	33.7±8.28
8–15	24.55±7.88	–3.12	<.01	30.93±7.39
16–25	25.25±11.63	–3.36	<.001	33.74±6.95
26–term	29.31±8.37	–2.55	<.01	35.42±7.85
<i>Summarised β (12–32) –power (%)</i>				
All	16.49±6.42	4.28	<.001	13.33±3.63
0–7	15.86±7.13	1	>.05	13.94±2.75
8–15	14.97±7.72	1.48	>.05	12.75±2.59
16–25	17.76±5.8	3.7	<.001	13.2±3.1
26–term	17.09±7.06	2.27	<.01	13.92±4.63

Note: Bonferroni corrected α -level of <.001 was used to assess statistical significance.

of summarised δ -power (regression coefficient =.46; $P<.001$) and β - power (regression coefficient =.22; $P=.002$), and for a decrease of θ - power (regression coefficient =–.48; $P<.001$) and α -power (regression coefficient =–.35; $P<.001$) (Table 9). This dose-effect relationship was the most pronounced in the children exposed at 8–25 weeks, especially at 16–25 weeks after fertilisation. Thyroid foetal dose was also the predictor for an increase of summarised δ -power (regression coefficient =.49; $P<.001$) and for a decrease of θ - power (regression coefficient =–.5; $P<.001$) and α -power (regression coefficient =–.32; $P<.001$). This dose-effect relationship was the most pronounced in the children exposed at 16–25 weeks after fertilisation (Figure 8).

The correlations between intelligence and spectral power of EEG were revealed as follows. Full scale IQ deterioration was associated with an increase of δ -power ($r=.25-.35$; $P<.001$), especially at the left frontal region ($r=.31-.35$; $P<.001$), a decrease of α -power ($r=.27-.36$; $P<.001$), especially at the left parieto-occipital region ($r=.33-.36$; $P<.001$), as well as a lateralisation of β -power to the left fronto-temporal region ($r=.2$; $P=.02$).

Verbal IQ deterioration was associated with an increase of δ -power ($r=.25-.41$; $P<.001$), mainly in the left hemisphere, especially at the left frontal region ($r=.38-.41$; $P<.001$), a decrease of α -power ($r=.22-.38$; $P<.001$), also mainly in the left hemisphere, especially at the left frontal region ($r=.34-.38$; $P<.001$), as well as an increase of β -power ($r=.27$; $P<.001$). Performance IQ deterioration was associated with an increase of δ -power ($r=.15-.28$; $P<.001$), mainly in the right hemisphere, especially at the right parietal region ($r=.21-.28$; $P<.001$), a decrease of α -power ($r=.17-.26$; $P<.001$), also especially at the right parietal region ($r=.23-.26$; $P<.001$), as well as an increase of β -power ($r=.21-.27$; $P<.001$) at the right temporal region. WISC performance/verbal discrepancies with verbal decrements were associated with lateralisation of δ -power towards the left parietal region ($r=.24$; $P=.04$), a decrease of θ -power in the left fronto-temporal region

Table 9 Relationships between EEG and doses of prenatal irradiation.

Age in weeks after fertilisation	Dose	Regression coefficient	F _(df1, df2)	p
<i>Summarised δ (1–4 Hz)-power (%)</i>				
All	Thyroid foetal	.49	61.2214 _(1,152)	.000000
	Foetal	.46	54.5663 _(1,198)	.000000
0–7	Foetal	.45	12.7301 _(1, 43)	.0008
8–15	Thyroid foetal	.43	11.3462 _(1,54)	.001
	Foetal	.42	10.7512 _(1,54)	.002
16–25	Thyroid foetal	.49	15.6218 _(1,45)	.0002
	Foetal	.46	13.3483 _(1,45)	.0006
26–term	Thyroid foetal	.54	18.6339 _(1,53)	.00009
	Foetal dose	.49	13.91842 _(1,53)	.0005
<i>Summarised θ (4–7) –power (%)</i>				
All	Thyroid foetal	–.5	64.3190 _(1,152)	.000000
	Foetal	–.48	60.3387 _(1,198)	.000000
0–7	Foetal	–.34	6.9570 _(1, 43)	.01
8–15	Thyroid foetal	–.51	17.2614 _(1,54)	.0001
	Foetal	–.53	19.1616 _(1,54)	.00006
16–25	Thyroid foetal	–.63	32.0500 _(1,45)	.000001
	Foetal	–.59	26.8140 _(1,45)	.000004
26–term	Thyroid foetal	–.43	10.2321 _(1,53)	.002
	Foetal dose	–.44	11.0047 _(1,53)	.002
<i>Summarised α (7–12) –power (%)</i>				
All	Thyroid foetal	–.32	22.9415 _(1,152)	.000003
	Foetal	–.35	27.0970 _(1,198)	.000000
0–7	Foetal	–.26	3.6292 _(1, 43)	.06
8–15	Thyroid foetal	–.26	3.5650 _(1,54)	.06
	Foetal	–.31	5.3726 _(1,54)	.02
16–25	Thyroid foetal	–.35	6.7276 _(1,45)	.01
	Foetal	–.39	8.6232 _(1,45)	.005
26–term	Thyroid foetal	–.39	8.2347 _(1,53)	.006
	Foetal dose	–.3	4.4584 _(1,53)	.04
<i>Summarised β (12–32) –power (%)</i>				
All	Thyroid foetal	.14	3.7750 _(1,152)	.05
	Foetal	.22	9.9334 _(1,198)	.002
0–7	Foetal	.09	0.4783 _(1, 43)	.5
8–15	Thyroid foetal	.11	0.6035 _(1,54)	.4
	Foetal	.23	2.8587 _(1,54)	.1
16–25	Thyroid foetal	.14	0.944 _(1,45)	.3
	Foetal	.44	6.6197 _(1,45)	.01
26–term	Thyroid foetal	.17	1.3397 _(1,53)	.2
	Foetal dose	.11	0.5989 _(1,53)	.4

($r=.27-31$; $P<.001$), as well as an increase of β -power ($r=.2-27$; $P<.001$).

Although intelligence is an integrative function of the human brain, full scale IQ and, especially, verbal IQ are closer associated with the left hemisphere functions, whereas performance IQ — with the right hemisphere ones. According to the data obtained a possible cerebral basis of full scale IQ and verbal IQ deterioration as well as WISC performance/verbal discrepancies with verbal decrements in the prenatally irradiated children is dysfunction of the left frontal, temporal and parietal lobes. This dysfunction apparently involves the cortico-limbic system, prefrontal cortex (frontal associative area), the secondary cortical receptor fields (temporal associative area), and the tertiary parietal associative area at the left, dominating, hemisphere [56, 57].

It seems to be possible to attribute this central nervous system dysfunction to prenatal exposure to ionising radiation, especially at the second critical period of cerebrogenesis (16–25 weeks after fertilisation)

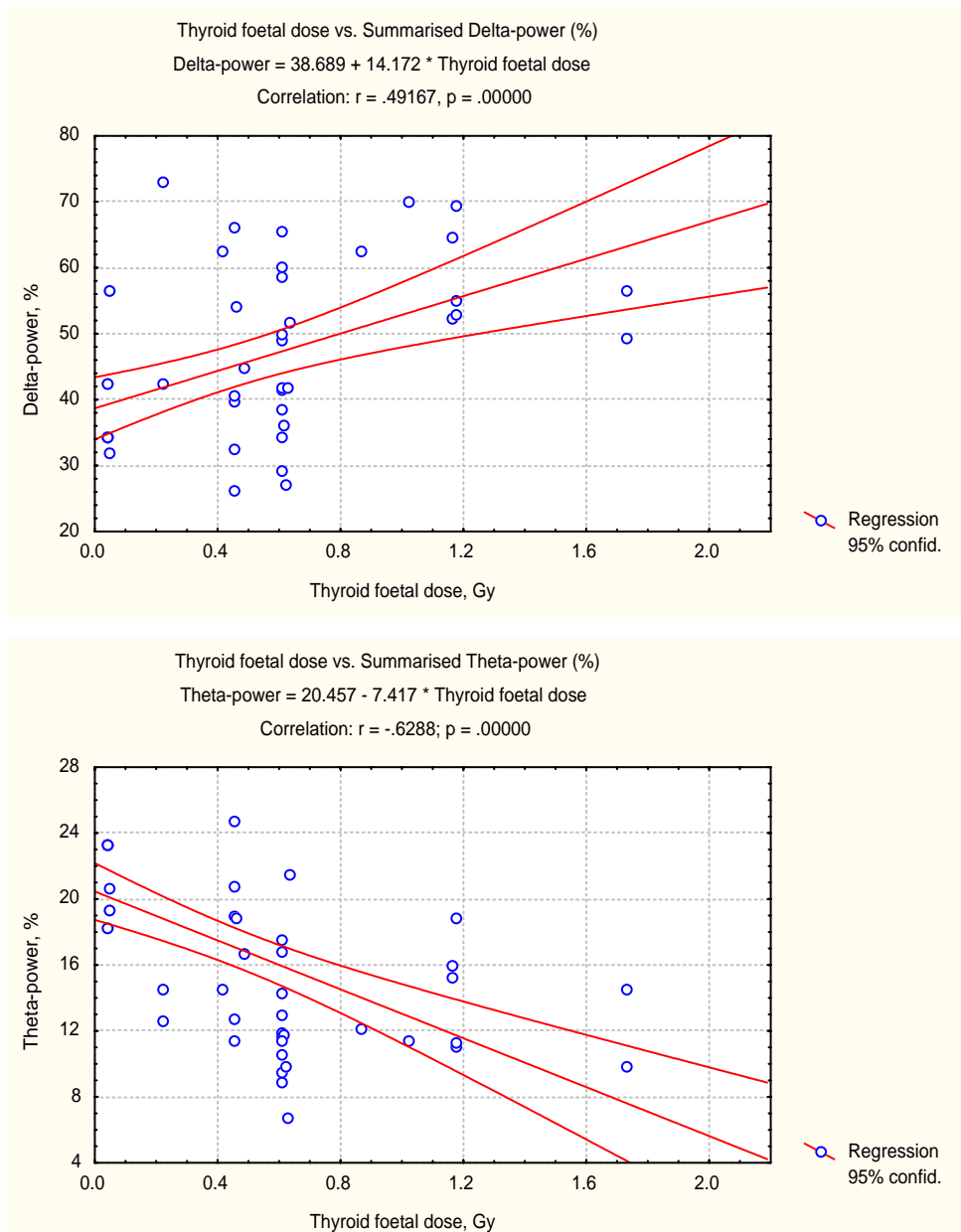

Figure 8. Relationships between summarised δ (1–4 Hz)-power (%) and summarised θ (4–7) – power (%) vs. foetal thyroid dose, in children of the both groups (n=47) exposed at 16–25 weeks after fertilization.

— the time of the most sophisticated events of brain creation, as well as limbic system, brain asymmetry and hemisphere dominating forming [58–60]. Moreover, radiation-induced malfunction of the foetal thyroid-pituitary system cannot be excluded.

ICD-10 diagnosis

According to the ICD-10 clinical descriptions and diagnostic guidelines, neurological disorders were revealed in 65 of the children of the acutely exposed group and in 25 of the classmates ($\chi^2=27.85$; $P<.001$) (Table 10). The overwhelming majority of this pathology were episodic and paroxysmal disorders, which were revealed significantly more often in the acutely exposed group than in the comparison group (61% vs. 29%; $\chi^2=20.69$; $P<.001$). The children-evacuee had significantly more epilepsy (G40) and migraine (G43) than the classmates. Epilepsy and other paroxysmal disorders were verified by clinical EEG, when clinical pattern of episodic or paroxysmal disorder corresponded to paroxysmal brain electrical activity (spikes, spike-waves, acute and slow waves of high amplitude >100 mkV).

Mental and behavioural disorders according to the ICD-10 criteria were revealed in 90 of the children of the acutely exposed group and in 52 of the classmates ($\chi^2=35.97$; $P<.001$) (Table 10). Organic, including symptomatic, mental disorders (F06, F07), somatoform autonomic dysfunction (F45.3), disorders of psychological development (F80–F89), and behavioural and emotional disorders with onset usually occurring in childhood and adolescence (F90–F98) were diagnosed significantly more often in the acutely exposed group than in the comparison group. Mental comorbidity was 24% in the acutely exposed group and 7% in the comparison group ($\chi^2=11.03$; $P<.001$).

Organic mental disorders were verified by Brain Mapping of QEEG and Visual Evoked Potentials (VEP) and in a number of cases by MRI and CT. Two cases of F07 (Personality and behavioural disorders due to brain disease, damage and dysfunction) and 6 cases of F06 (Other mental disorders due to brain damage and dysfunction and to physical disease) from the acutely exposed group were due to epilepsy (G40), while 1 of F06 from the comparison group was due to epilepsy. Two cases of F07 from the acutely exposed group were linked to mental retardation (F70 and F71). One case of F07 and 14 cases of F06 from the acutely exposed group, as well as 5 cases of F06 from the comparison group were attributed to the evidences of perinatal, predominantly pre- and intrenatal, pathology, i.e. pathology during *in utero* period and delivery, such as moderate to severe toxicosis of pregnancy, uterine haemorrhage during pregnancy, risk of miscarriage, waterless period during delivery, too short- or too long-time period of delivery, hypoxia of foetus and asphyxia of newborn.

The more severe neuropsychiatric disorders — mental retardation, epilepsy, and organic mental

Table 10 Diseases of the nervous system, mental and behavioural disorders according to the ICD-10 criteria.

ICD-10 code	Acutely exposed group	χ^2	P	Comparis on group
<i>Diseases of the nervous system (G00—G99)</i>				
Without neuropathology	38	27.85	<.001	75
Episodic and paroxysmal disorders (G40—G47):	61	20.69	<.001	29
G40 Epilepsy	8	5.7	<.05	1
G43 Migraine	8	8.33	<.05	0
G44 Other headache syndromes	36	3.43	>.05	24
G47 Sleep disorders	9	2.06	>.05	4
G90.8 Other disorders of autonomic nervous system	5	5.13	<.05	0
<i>Mental and behavioural disorders (F00—F99)</i>				
Without psychopathology	10	35.07	<.001	48
Organic, including symptomatic, mental disorders (F00–F09):	25	13.78	<.001	6
F06 Other mental disorders due to brain damage and dysfunction and to physical disease	20	8.66	<.01	6
F07 Personality and behavioural disorders due to brain disease, damage and dysfunction	5	5.13	<.05	0
F12 Mental and behavioural disorders due to use of cannabinoids	1	1.01	>.05	0
Neurotic, stress-related and somatoform disorders (F40–F48):	36	0.56	>.05	31
F45.3 Somatoform autonomic dysfunction	23	10.04	<.01	7
F48.0 Neurasthenia	13	4.01	<.05	24
F51 Nonorganic sleep disorders	6	2.08	>.05	2
Mental retardation (F70—F79):	2	2.02	>.05	0
F70 Mild mental retardation	1	1.01	>.05	0
F71 Moderate mental retardation	1	1.01	>.05	0
Disorders of psychological development (F80–F89)	12	12.77	<.001	0
Behavioural and emotional disorders with onset usually occurring in childhood and adolescence (F90–F98)	33	4.34	<.05	20
Mental comorbidity	24	11.03	<.001	7

disorders — were diagnosed in 25 acutely exposed children and in 6 classmates ($\chi^2=13.78$; $P<.001$). The majority (16) of the acutely exposed children with these disorders (including 2 cases of mental retardation) were irradiated at 8–15 and 16–25 weeks after fertilisation. Thyroid foetal dose of these children with severe neuropsychiatric disorders was significantly higher than in other children of the acutely exposed group ($.78\pm.31$ vs. $.59\pm.28$, $t = 2.79$, $P<.01$).

It is clear that the children's neuromental disorders are etiologically heterogeneous. Higher economical level of a family, better somatic health of a child, better mental health of parents are the contributors towards a better children's neuromental health. Higher doses of prenatal irradiation, especially foetal thyroid dose, more severe stress events, and additional mother's hazards in the prenatal period, worse mother's mental health, as well as problems of the perinatal period are the contributors towards children's neurological and mental health deterioration.

Discussion and Conclusions

The UNSCEAR Report-2000, Annex J: Exposure and Effects of the Chernobyl Accident [61] touched the problem of the psychological development of the children who were exposed to radiation from the Chernobyl accident *in utero* basing on one publication only [21] where cognitive, emotional and behavioural disorders in prenatally irradiated children were attributed exclusively to unfavourable social-psychological and social-cultural factors.

The WHO Pilot Project «Brain Damage in Utero» International Advisory Board assumes that prenatal exposure to the Chernobyl disaster can give rise to a dysfunctional child, either because of organic damage to the developing brain or because of the disturbed psychosocial milieu. Indeed, intelligence peculiarities, neurophysiological abnormalities, and neuromental health deterioration in the children acutely prenatally exposed to both radiation and stress are etiologically multifactorial. Although the children were affected by multiple exposure including prenatal stress and current social, economical and medical problems in their families, the «dose—effects» relationships concerning both intelligence and EEG-parameters, which are the most marked at the critical periods of cerebrogenesis, testify to significant contribution of prenatal irradiation into the brain damage.

This study confirms and develops the results of the WHO Pilot Project «Brain Damage in Utero» [15, 17] and relevant studies [18–22] concerning mental health and intelligence deterioration in children exposed *in utero* as a result of the Chernobyl disaster. Unlike to the study [21] where the authors did not find evidences of the contribution of prenatal irradiation on the children's intelligence deterioration, we have done it. The differences between the results of the study [21] and ours we can explain by the followings: 1) different sample: we examined acutely exposed in 1986 children, but they — those resettled in 5–7 years after the disaster, and 2) different measures: they analysed full scale IQ only, but we — verbal IQ (including subtests), performance IQ (including subtests), WISC performance/verbal discrepancies, and full scale IQ. Exactly deterioration of verbal IQ and WISC performance/verbal discrepancies with verbal decrements, were in proportion to the foetal thyroid dose.

Our data do not confirm the results of the studies [23–25] concerning similarity and normality of mental and physical health, intelligence similarity of acutely prenatally exposed children in the Chernobyl exclusion zone evacuated to Kiev and children-classmates living in Kiev, as well as that the most important risk factors were maternal somatization and Chernobyl-related stress. A possible explanation of the differences between the results of the studies [23–25] and ours study seems to be as follows: 1) Restricted neuropsychological battery for children's intelligence assessment allowed them [25] to measure spatial intelligence only, which indeed looks likely to be intact; 2) An absence of clinical neuropsychiatric examination by ICD-10 or DSM-IV criteria and screening-like physical examination in the works [23, 24] resulted their conclusion concerning evacuee children's mental and physical welfare to be the point at issue. 3) Inadequate using of gestation months for analysis, but not periods of cerebrogenesis (0–7, 8–15, 16–25, and 26+ weeks after fertilisation),

and possible uncertainties in the gestation term estimation did not enable in the studies [23–25] to estimate the most important factor in determining the nature of the insult to the developing brain from ionising radiation [2] — exposure in critical and «non-critical» periods of prenatal development. 4) An absence of dosimetric data for both children-evacuee and non-evacuee did not enable them [23–25] to study a possible dose-effect relationship and to estimate the contribution of ionising radiation towards intelligence and psychological development of the children. However, the most important reason of the differences between their and our studies seems to be the different paradigms of the researches: psychosocial model of the studies [23–25], and neuropsychiatric or neurobiological — in us.

It should be noted limitations and uncertainties of this study. First of all, there is a problem of representativeness of the sample: a possible bias towards «improving selection» where some disabled children due to neuropsychiatric problems could be dropped out from the study, or «deteriorating selection» when for instance prodigy infants attending special advanced schools were also out of the sample. Ideally, all parentally exposed children, or at least all those who had been evacuated from the Chernobyl exclusion zone, should be involved in the study. However, our sample — evacuee in Kiev and non-evacuee classmates living in Kiev — looks quite good from the point of view of similarity about informational and urban saturation environment, providing as much as possible in Ukraine. It should be also stressed that the uncertainties of individual doses estimation are due to an absence at present of generally accepted methodology concerning model of foetal dose assessment. Probably, like in Japan, there will be further new dosimetric systems and reassessment of psychometrical, neurophysiological and other data.

As it was mentioned above, our sample corresponds to subgroups of the Japanese sample [2]: prenatally exposed survivors to atomic bomb radiation of the foetal dose category less than 0.01 Gy (n=1,201) — to the Ukrainian comparison group, and those of the dose category 0.01–0.09 Gy (n=322) — to the Ukrainian acutely exposed group. However, there is an extremely important radiological difference between the Japanese and Ukrainian samples — prenatal exposure to radioactive isotopes of iodine. The prenatally exposed to atomic bomb radiation had not been irradiated by radioiodine, but the prenatally exposed children as a result of the Chernobyl disaster received quite significant foetal thyroid doses. This fact makes difficult to extrapolate all data (risks, thresholds of the effects, etc.) from the Japanese sample on the Chernobyl one. It seems that the acutely prenatally exposed children at the Chernobyl exclusion zone is a unique sample that should be used for reassessment of risks of prenatal irradiation at radiation accidents on nuclear reactors.

The results of this study agree with the Japanese studies concerning 1) dose related full scale IQ reduction [10], 2) an increase of paroxysmal disorders [62], 3) critical periods of cerebrogenesis — 8–15 and, especially, 16–25 weeks after fertilisation [2]. The highest vulnerability of the brain under exposure at 16–25, but not 8–15 weeks after fertilisation as in the Japanese sample, we can explain by 1) maximal radioiodine transfer rate in foetal thyroid at about 20–25 weeks [33], 2) more «delicate» examination of intelligence disturbances that corresponds exactly to the events of the brain creation at 16–25 weeks after fertilisation (neuronal differentiation, limbic system and brain asymmetry forming, apoptosis beginning etc. [58–60]). An absence of dramatic increase of mental retardation, especially its severe form, as well as microcephalia obviously can be explained by significantly lower foetal doses of irradiation than that in the atomic bomb survivors.

Following recommendations of Shull & Otake [63] concerning future studies of the prenatally exposed survivors and the WHO Pilot Project «Brain Damage in Utero» International Advisory Board for the second phase of the project, we used QEEG and WISC. This resulted in interesting findings of verbal IQ reduction and WISC performance/verbal discrepancies with verbal decrements, which were in proportion to the foetal thyroid dose, especially among those children exposed at 16–25 weeks after fertilisation. Previously we reported [16, 26, 27] about TSH level grows with foetal thyroid dose increase with a 0.3 Sv threshold. Probably, these children had been affected by intrauterine hypothyroidism that resulted in intelligence disturbances during their life. Obviously, an international psychoendocrine study should be organised for

exploration of functions of the pituitary-thyroid system as a possible biological basis of mental health problem in children irradiated in utero as a result of the Chernobyl disaster.

The prenatally acutely exposed children have quite distinguished pattern of summarised EEG spectral power (increased δ - and β - and decreased θ - and α -power), in comparison with both the classmates and literature normative data [41, 55]. Foetal dose and thyroid foetal dose were the predictors of this QEEG-pattern, especially among the children irradiated at 16–25 weeks after fertilisation.

Neurophysiological abnormalities together with intelligence disturbances, both dose-related, especially at 16–25 weeks after fertilisation, as well as a «concentration» of the most severe neuropsychiatric disorders among the children exposed at the critical periods of cerebrogenesis, can testify to the developing brain abnormalities due to multiple factors including the effects of prenatal irradiation.

Verbal IQ deterioration together with lateralisation of abnormal electrical activity to the left hemisphere supports our previous report about the predominance of the left hemisphere dysfunction in prenatally irradiated children [28]. Association of verbal IQ and left hemisphere is well-known [64], and full scale IQ is closer related to the left than to the right hemisphere [56]. It seems that the left hemisphere is more vulnerable to exogenous impacts including ionising radiation than the right hemisphere, probably due to dominating of the left brain and, consequently, its more functional activity.

A possible cerebral basis of intelligence disturbances in prenatally irradiated children is dysfunction of the left frontal, temporal and parietal lobes, involving the cortico-limbic system, prefrontal cortex, temporal associative area, and the tertiary parietal associative area at the left dominating hemisphere [56, 57]. However, the predominance of the left hemisphere dysfunction is leading towards higher risk of schizophrenia spectrum disorders in prenatally irradiated children, which is why the long-term follow up study of this cohort is of great importance for clinical medicine and neuroscience.

Thus, the neuromental health of the acutely prenatally irradiated children at the Chernobyl exclusion zone is deteriorated in comparison with the non-evacuee classmates living in Kiev due to more frequent occurrences of episodic and paroxysmal disorders, organic, including symptomatic, mental disorders, somatoform autonomic dysfunction, disorders of psychological development, and behavioural and emotional disorders with onset usually occurring in childhood and adolescence. Obviously, their neuromental health disorders are etiologically heterogeneous including psycho-social and economic factors, medical problems in their families. The effect of real stress events (but not only their perception) during pregnancy together with prenatal irradiation cannot be excluded.

Intelligence of the acutely prenatally irradiated children is deteriorated due to reduction of full scale and verbal IQ, as well as WISC performance/verbal discrepancies with verbal decrements. Although the children's intelligence is multifactorial, the contribution of prenatal irradiation was revealed.

Characteristic neurophysiological changes of the acutely prenatally irradiated children are also etiologically heterogeneous, but the dose-effect relationship, especially at critical periods of cerebrogenesis, testifies the impact of prenatal irradiation.

This study suggests that prenatal exposure to ionising radiation at thyroid foetal dose 0.2–2 Gy and foetal dose 11–92 mSv can result in detectable brain damage.

The data obtained reflect great importance, interdisciplinarity, and complexity of such problem as brain damage *in utero* following radioecological disaster and a necessity to integrate international efforts to its solving.

References

1. R. Corbett. Radiation, pregnancy and the patient. *Radiological Protection Bulletin*, **208**, 16–19 (1998).
2. ICRP Publication 49, Developmental effects of irradiation on the brain of the embryo and fetus. A report of a Task Group of Committee 1 of the International Commission on Radiological Protection, 1986. In *Annals of the ICRP* (M.C. Thorne, Ed.), **16** (4). Pergamon Press, Oxford, 1986.

3. M.H. Teicher, S.L. Andersen, C.A. Glod, C.P. Navalta and H.A. Gelbard, Neuropsychiatric disorders of childhood and adolescence. In *The American Psychiatric Press Textbook of Neuropsychiatry* (S.C. Yudofsky and R.E. Hales, Eds.) (3rd ed.), Chapt. 33, pp. 903–940. American Psychiatric Press, Inc., Washington, 1997.
4. P. Rakic, Neuronal migration and contact guidance in the primate telencephalon. *Postgraduate Medical Journal*, **54**, 25–40 (1978).
5. P. Rakic, Development of the primate cerebral cortex. In *Child and Adolescent Psychiatry* (M. Lewis, Ed.), pp. 11–28. Williams & Wilkins, Baltimore, 1994.
6. R.L. Sidman and P. Rakic, Development of the human nervous system. In *Histology and Histopathology of the Nervous System* (W. Haymaker and R.D. Adams, Eds.), pp. 3–145. C. C. Thomas, Springfield, Virginia, 1982.
7. L.F. Saugstad, Cerebral lateralisation and rate of maturation. *International Journal of Psychophysiology*, **28** (1), 37–62 (1998).
8. United Nation Scientific Committee on Effects of Atomic Radiation (UNSCEAR) *Source, Effects and Risks of Ionizing Radiation*. Report to General Assembly with Annexes. United Nations, New York, 1993.
9. M. Otake and W.J. Schull, In utero exposure to A-bomb radiation and mental retardation: A reassessment. *British Journal of Radiology*, **57**, 409–414 (1984).
10. W.J. Schull and M. Otake, The central nervous system and in utero exposure to ionizing radiation: The Hiroshima and Nagasaki experiences. In *Epidemiology and Quantitation of Environmental Risk in Humans from Radiation and Other Agents* (A. Castellani, Ed.), pp. 515–536. Plenum Press, New York, 1985.
11. M. Otake and W.J. Schull Radiation-related brain damage and growth retardation among the prenatally exposed atomic bomb survivors. *International Journal of Radiation Biology*, **74** (2), 159–171 (1998).
12. M. Otake, W.J. Schull and S. Lee, Threshold for Radiation-related severe mental retardation in prenatally exposed A-bomb survivors: a re-analysis. *International Journal of Radiation Biology*, **70** (6), 755–763 (1996).
13. Y. Imamura, Y. Nakane, H. Kondo, M. Kishikawa and Y. Ohta, Lifetime prevalence of schizophrenia of people prenatally exposed to A-bomb radiation in Nagasaki. In *Proceedings of the International Conference on the Mental Health Consequences of the Chernobyl Disaster: Current State and Future Prospects*, Kiev, May 24–28, 1995 (A.I. Nyagu, Ed.), pp. 314–315. Krezchatic Publishing House, Kiev, 1995.
14. Y. Imamura, Y. Nakane, Y. Ohta and H. Kondo, Lifetime prevalence of schizophrenia among individuals prenatally exposed to atomic bomb radiation in Nagasaki City. *Acta Psychiatrica Scandinavia*, **100** (5), 344–349 (1999).
15. *Health Consequences of the Chernobyl Accident. Results of the IPHECA Pilot Projects and Related National Programmes. Scientific Report* (G.N. Souchkevitch and A.F. Tsyb, Eds.). World Health Organization, Geneva, 1996.
16. A.I. Nyagu, K.N. Loganovsky, A.K. Cheban, V.S. Podkorytov, Yu.I. Plachinda, K.L. Yuriev, Ye.Yu. Antipchuk and T.K. Loganovskaja, Mental health of prenatally irradiated children: a psychophysiological study. *Social and Clinical Psychiatry*, **6** (1), 23–36 (1996).
17. I.A. Kozlova, A.I. Nyagu and V.D. Korolyov, An influence of radiation to the mental health of children. *Zhurnal Nevrologii I Psikhiatrii imeni S.S. Korsakov*, **99** (8), 12–15 (1999).
18. L.A. Ermolina, N.K. Sukhotina, O.D. Sosyukalo, A.A. Kashnikova and I.N. Tatarova, The effects of low radiation doses on children's mental health (radiation-ontogenetic aspect). Report 2. *Social and Clinical Psychiatry*, **6** (3), 5–13 (1996).
19. F.M. Gayduk, S.A. Igumnov and V.B. Shalckevich, The complex estimation of neuro-psyche development of children undergone to radiation exposure in prenatal period as a result of Chernobyl disaster. *Social and Clinical Psychiatry*, **4** (1), 44–49 (1994).
20. S.A. Igumnov, Psychological development of children exposed to radiation in prenatal period as a result of the Chernobyl disaster. *The Acta Medica Nagasakiensia*, **41** (3–4), 20–25 (1996).
21. Y. Kolominsky, S. Igumnov and V. Drozdovitch, The psychological development of children from Belarus exposed in the prenatal period to radiation from the Chernobyl Atomic Power Plant. *Journal of Child Psychology and Psychiatry*, **40** (2), 299–305 (1999).
22. S. Igumnov and V. Drozdovitch, The intellectual development, mental and behavioural disorders in children from Belarus exposed in utero following the Chernobyl accident. *Eur. Psychiatry*, **15** (4), 244–253 (2000).
23. E.J. Bromet, D. Goldgaber, G. Carlson, S. Lyubsky, T. Gilbert, S. Gluzman, N. Panina, E. Golovakha, D. Gluzman

- and A. Gorbachik, Children's mental health 11 years after the Chernobyl catastrophe. *Journal of Ukrainian Psychiatry Association*, **4** (12), 37–63 (1998).
24. E.J. Bromet, D. Goldgaber, G. Carlson, N. Panina, E. Golovakha, S. Gluzman, T. Gilbert, D. Gluzman, S. Lyubsky and J.E. Schwartz, Children's well-being 11 years after the Chernobyl catastrophe. *Archives of General Psychiatry*, **57**, 563–571 (2000).
 25. L. Litcher, E.J. Bromet, G. Carlson, N. Squires, D. Goldgaber, N. Panina, E. Golovakha and S. Gluzman, School and neuropsychological performance of evacuated children in Kyiv 11 years after the Chernobyl disaster. *Journal of Child Psychology and Psychiatry*, **41** (3), 291–299 (2000).
 26. A.I. Nyagu, K.N. Loganovsky and T.K. Loganovskaja, Psychophysiological aftereffects of prenatal irradiation. *International Journal of Psychophysiology*, **30** (3), 303–311 (1998).
 27. A.I. Nyagu, A.K. Cheban, V.A. Salamatov, G.F. Limanskaja, A.G. Yazchenko, G.N. Zvonaryeva, G.D. Yakimenko, K.V. Melina, Yu.I. Plachinda, A.A. Chumak, D.A. Bazyka, G.M. Gulko, V.V. Chumak and I.A. Volodina, Psychosomatic health of children irradiated in utero as a result of the Chernobyl accident. In: Proceedings of the International Conference «*Social, Psychological, and Psychoneurological Aspects of Chernobyl NPP Accident Consequences*» Kiev, September 28–30, 1992 (A.I. Nyagu, Ed.), pp. 265–270, Association «Physicians of Chernobyl», Ukrainian Scientific Centre for Radiation Medicine, Kiev, 1993.
 28. T.K. Loganovskaja and K.N. Loganovsky, EEG, cognitive and psychopathological abnormalities in children irradiated in utero. *International Journal of Psychophysiology*, **34** (3), 213–224 (1999).
 29. *National Report of Ukraine «Ten Years after the Chernobyl Disaster»*: State Report prepared under supervision of the Ministry of Ukraine for Problems of Population Defense from Chernobyl Disaster on the 10th anniversary of the Chernobyl accident and officially reported by the Minister at the International Conference «One decade after Chernobyl», Vienna, 8–12 April 1996, European Commission, International Atomic Energy Agency, World Health Organization, 1996.
 30. M. Otake, W.J. Schull and H. Yoshimaru, Brain damage among prenatally exposed. *Journal of Radiation Research, Supplement (A review of Forty-Five Years Study of Hiroshima and Nagasaki Atomic Bomb Survivors)*, 249–264 (1991).
 31. I.A. Likhtarev, V.V. Chumak and V.S. Repin, Retrospective reconstruction of individual and collective external gamma-doses of population evacuated after the Chernobyl accident. *Health Physics*, **66** (6), 10 (1994).
 32. V.S. Repin (1996) *Radiation and hygienic meaning of sources and irradiation doses of population of the 30-kilometer zone after the Chernobyl NPP accident (problems of reconstruction, risk assessment)*. Thesis for seeking of scientific degree of Doctor of Biological Sciences on speciality 14.02.02 – hygiene, Institute of Medicine of Labour, Kiev, 1996.
 33. *Instruction of Ministry of Public Health of the USSR for monitoring and treatment of pregnant women and newborns exposed to radiation as a result of an accident at Nuclear Power Plant (on observations in 1986–1988)*. Ministry of Public Health of the USSR, Moscow, 29.10.86, No 1433, 1986.
 34. D. Wechsler, *Manual for the Wechsler Intelligence Scale for Children — Third Edition UK*. The Psychological Corporation, Harcourt Brace Jovanovich, Publishers, London, 1992.
 35. *Measurement of intelligence of children: Manual for practician psychologists. Part 1. Human intelligence and its measurement: Theory and practice* (Yu.Z. Gilbukh, Ed.), Research Institute of Psychology, Academy of Pedagogic Sciences of Ukraine, Kiev, 1992.
 36. J.R. Hughes and E.R. John, Conventional and quantitative electroencephalography in psychiatry. *Journal of Neuropsychiatry and Clinical Neuroscience*, **11** (2), 190–208 (1999).
 37. D.A. Hoffman, J.E. Lubar, R.W. Thatcher, M.B. Serman, P.J. Rosenfeld, S. Striefel, D. Trudeau and S. Stockdale, Limitations of the American Academy of Neurology and American Clinical Neurophysiology Society paper on QEEG. *Journal of Neuropsychiatry and Clinical Neuroscience*, **11** (3), 401–407 (1999).
 38. E.A. Zhirmunskaya, *Clinical Electroencephalography*, MAYBE Publishing House, Moscow, 1991.
 39. D.A. Farber and V.V. Alferova *Electroencephalography in Children and Adolescents*. Pyedagogica Publishing House, Moscow, 1972.
 40. L.R. Zenkov and M.A. Ronkin, *Nervous Diseases Functional Diagnostics*, Medicine Publishing House, Moscow, 1991.
 41. *Electroencephalography. Basic Principles, Clinical Application and Related Fields* (E. Niedermeyer and F.L.

- DaSilva, Eds.), 3rd ed. Williams & Wilkins, Baltimore, 1993.
42. M.A. Rutter, A children's behaviour questionnaire for completion by teachers: Preliminary findings. *Journal of Child Psychology and Psychiatry*, **8**, 1–11 (1967).
 43. T.M. Achenbach, *Manual for the CBCL/4–18 and 1991 Profile*. University of Vermont Department of Psychiatry, Burlington, VT, 1991.
 44. A.S. Carter, B.L. Grigorenko and D.L. Pauls, A Russian adaptation of the Child Behavior Checklist: Psychometric properties and association with child and maternal affective symptomatology and family functioning. *Journal of Abnormal Child Psychology*, **23**, 661–684 (1995).
 45. V.V. Sedney, Diagnostic of neurotic disorders in children of youngest and middle school age. Children Questionnaire of Neurosis (CQN). *Practical Psychology and Social Work* **2**, 17–20 (1998).
 46. D. Goldberg and K. Bridges, Screening for psychiatric illness in general practice: the general practitioner versus the screening questionnaire. *Journal of the Royal College of General Practitioners*, **2**, 15–18 (1987).
 47. D. Goldberg and P. Williams, *A Users Guide to the General Health Questionnaire*. NFER–Nelson, London, 1988.
 48. M.J. Horowitz, *Stress Response Syndromes*. Jason Aronson, New York, 1976.
 49. W.W.K. Zung and T.H. Wonnacott, Treatment prediction in depression using a self-rating scale. *Biological Psychiatry*, **2**, 321–329 (1970).
 50. *Diagnostic and Statistical Manual of Mental Disorders, 4th Edition, DSM-IV*. American Psychiatric Association, Washington, 1994.
 51. J.W. Kuzma, *Basic Statistics for the Health Science*. Mayfield Publishing Company, Palo Alto, California, 1984.
 52. D.C. Montgomery, *Design and Analysis of Experiments*. John Wiley & Sons, New York, 1976.
 53. R.E. Kirk, *Experimental Design: Procedures for the Behavioral Sciences*. Brooks/Cole Publishing Company, Monterey, 1982.
 54. L.A. Ilyin, *Reality and Myths of Chernobyl*. ALARA Ltd Publishing House, Moscow, 1994.
 55. M. Rutter and L. Hersov, *Child and Adolescent Psychiatry. Modern approaches*. 2nd ed. Blackwell Scientific Publications, Oxford, 1985.
 56. R. Joseph, *Neuropsychiatry, Neuropsychology, and Clinical Neuroscience*. 2nd ed. Williams & Wilkins, Baltimore, 1996.
 57. P. Duus, *Topical Diagnosis in Neurology. Anatomy. Physiology. Signs Symptoms*. Translated to Russian by A. Belova, V. Grigorieva, and B. Likhberman. Edited by L. Likhberman. Vazar—Ferro Publishing House, Moscow, 1996.
 58. W.M. Cowan, J.W. Fawcett, D.D.M. O'Leary, and B.B. Stanfield, Regressive events in neurogenesis. *Science*, **225**, 1258–1265 (1984).
 59. M.A. England, *Life Before Birth (2nd ed.)*. Mosby–Wolfe, London, 1996.
 60. N. Zecevic, Synaptogenesis in layer-I of the human cerebral cortex in the first-half of gestation. *Cerebral Cortex*, **8** (3), 245–252 (1998).
 61. UNSCEAR 2000 Report to the General Assembly. Annex J: Exposure and Effects of the Chernobyl Accident. *International Journal of Radiation Medicine*, **2–4 (6–8)**, 3–109 (2000).
 62. W.J. Shull and M. Otake, Cognitive function and prenatal exposure to ionizing radiation. *Teratology*, **59** (4), 222–226 (1999).
 63. W.J. Shull and M. Otake, Future studies of the prenatally exposed survivors. *Journal of Radiation Research, Supplement (A review of Forty-Five Years Study of Hiroshima and Nagasaki Atomic Bomb Survivors)*, 385–393 (1991).
 64. Flor-Henry, P. (1983) *Cerebral Basis of Psychopathology*. Boston: John Wright, PSG Inc.

Health State of Belarusian Children Suffering from the Chernobyl Accident: Sixteen Years after the Catastrophe

Alexander N. ARYNCHYN, Tatiana V. AVHACHEVA, Nika A. GRES,
Ekaterina I. SLOBOZHANINA*

*Research Clinical Institute for Radiation Medicine and Endocrinology; Aksakovschina, 223032 Minsk,
Belarus: arynchyn@hotmail.com*

**Institute of Photobiology, AMS: Kuprevich str. 2, 220141 Minsk, Belarus*

Abstract

A prospective cohort study was carried out to investigate the health state of Belarusian children suffering from the Chernobyl accident. The main group consisted of 133 children permanently residing in the radioactively contaminated territories, while the control group was 186 children permanently residing in the territories with natural radiation background. During the period of observation the constantly increased level of the annual summary effective dose of radiation (0.13-2.24 mSv) were revealed in the children of the main group. All members of both groups were clinically examined at least two times during the follow-up of 1990 - 2001. Heavy metals burden of Pb, Cd and Hg were also measured in urine excretion. The results of clinical examination clearly indicate that the frequency of complaints, as well as the frequency of major clinical syndromes and diagnoses, was increasing in both groups. A growth of the gastrointestinal pathology, as well as an increase in cardiovascular manifestations of the vegetative dysfunction syndrome, was the most important. It should be noted that practically all forms of studied nosology were more prevalent in the main group than in the control both at the first and the second examination. High values of relative risk (RR) of the main group were obtained for arterial hypotension (RR=2.21 and 3.73 at the first and the second examination, respectively) and cardiac metabolic dysfunction (RR=4.66 and 3.33). Aggravating situation of the health state of Belarusian children requires urgent prophylaxis measures for pathologies that are enhanced by environmental factors.

Introduction

Sixteen years passed after the Chernobyl accident, but the problem of radioactive contamination in Belarus is still actual. During the first months after the accident, radioactive iodine was the main dose-forming radionuclide. At present, radioactive cesium-137 holds this place [1-5]. Chronic radiation exposure by this radionuclide presents a great danger for the population living in the contaminated areas.

In the formation of exposure doses to the population, a considerable role belongs to the type of soils, which determines the rate of cesium radionuclide migration through the biological (food) chain. Peaty and swampy soils of Belarusian woodlands are typical in the territory of radiation control. These soils are characterized with high speed of migration in the biological chain [6]. As a consequence, increased radiocesium activity in milk is observed, as well as high radionuclide body burden. Residing in the radioactively contaminated territories leads to the formation of accumulated exposure dose of 80 mSv and greater in separate settlements of Gomel region during the whole period after the accident.

In addition to radioactive contamination, chemical contaminations with heavy metals such as lead (Pb), cadmium (Cd), mercury (Hg) etc. due to various social activities are also playing important roles in the appearance and development of diseases. Increase of lead burden in human body leads to brain malformation, embryonic development disorders, atrophy of mucous membrane of gastrointestinal tract, and impairment of structural and functional properties of erythrocyte membranes [7-10]. Cadmium effects

the state of cell immunity damaging the activity of polymorph nuclear leucocytes and inhibiting the processes of clonal differentiation and activation of mature lymphocytes [7]. Chronic mercury intoxication leads to an increase of goiter prevalence, disturbance of endocrine function of thyroid gland, membranous proteins SH-groups, oxidation, inhibition of activity of a number of enzymes [7,9].

In the territory of Belarus, a considerable amount of xenobiotics penetrates the organism of children. The response of children's organism to the effect of anthropogenic factors differs considerably from that of adult. Intensity of metabolic processes in children is higher than in adults, but the rate of xenobiotics' metabolism is lower. With an increase of concentration of chemical substances in the biosphere, the number of children with deviations of reactivity is growing [11]. The younger the child, the less manifest are specific features of toxic effect [12].

According to our studies, in rural districts of Brest and Gomel regions where the territories were contaminated by the Chernobyl accident, the proportion of the children found to be "contaminated" with lead are 41.1 and 56.7 %, respectively. While, a more favorable situation (15.2%) is observed in rural districts of Vitebsk region (control) where the technogenic effect is rather less.

Considering the aggravated environmental situation in Belarus, it is urgent to study the combined effects of radionuclide and several chemicals in their small concentrations, which are most frequent under the real condition. It should be noted that these effects are not manifested by typical signs of damage with clear-cut clinical pictures, but exist in the form of nonspecific reactions or syndromes of different degree of manifestation [13-18].

This report presents the results of a prospective cohort study we are continuing to investigate the health state of the children suffering from the combined effects of the long-term low-dose radiation and chemical exposure.

Material and Methods

Cohort selection

At the Pediatric Department of the Research Clinical Institute for Radiation Medicine and Endocrinology, during 1990 – 2001, a cohort prospective examination of children (individual examination in age dynamics) residing in the territory of the Republic of Belarus has been conducted. All the randomly selected children were divided into 2 groups: the main and the control. The main group included 133 children (73 boys and 60 girls) permanently residing in the radioactively contaminated territories of Gomel (Yelsk, Narovlya, Bragin districts), Mogilev (Cherikov) and Brest (Stolin, Luninets) regions. The control group consisted of 186 children (101 boys and 85 girls) permanently residing in the territories with natural radiation background (Braslav district of Vitebsk region).

Medical examination

Standardized protocol of clinical examination included the children's complaints and case history, pediatric examination, laboratory findings, ECG, ultrasound examination, fibrogastroscopy with gastric biopsy and morphological examination of gastric biopsies.

Clinical examinations of the selected children were performed at least two times: the first examination was 1995 - 1998 and the second - in 1998 – 2001. Average time interval between the examinations in the main group was 2.1 years (within the range from 1.5 to 2.5 years) and in the control group – 2.5 years (from 2 year to 3 years). Mean age of the children at the time of the first examination was 10.6 years (6 - 15 years) in the main group and in the control group – 9.5 years (6 - 14 years).

Dose assessment and heavy metals determination

Annual summary effective dose of radiation (ASED) was calculated as a result of both individual whole body counting for internal dose and gamma rate measurements on the ground for external dose [19]. All children underwent whole-body counting based on registration of gamma quantum in a scintillation detector with a sodium iodine crystal activated with thallium. The whole body counters used in this study

were permanently located at the regional centres and calibrated on a regular basis as part of a national programme for calculating annual internal dose to the population of Belarus. The calculation of external dose was based on the annual gamma rate measurements in the villages of Belarus and performed by the Belarus state committee for the control of radiological situation.

The urine level of lead (Pb), cadmium (Cd) and mercury (Hg) was determined with the method of roentgen spectral analysis, using a roentgen fluorescent spectrofluorimeter “Spectrace-5000” (“Trackor X-ray”, Netherlands).

Erythrocyte membranes state

Physical-chemical state in membrane lipids were estimated using luminescence of lipophylic fluorescent probe 1,6-diphenyl-1,3,5-hexatriene (DPH) and coefficient of pyren excimerization (CEP), included into the erythrocytes ghosts. Fluorescent parameters of erythrocytes membranes were measured using luminescent spectrophotometer LSF 222 (“Solar”, Belarus).

Data processing

Results of examination were input into a database (Paradox 4.0) and processed with methods of parametric and nonparametric statistics using SPSS 9.0 statistical package. Epidemiological analysis of data was performed with the help of EPIINFO6 (version 6.04 b). Relative risk (RR) with confidential intervals (CI) was calculated and relationships of two variables were determined using χ^2 -criteria. Results of the first and the second clinical and laboratory examination of children are analyzed in this article.

Results and discussion

Radio-ecological status

Radio-ecological parameters of both examined groups are shown in Table 1. The data given in Table 1 testify to a non-significant increase in ASED in the children of the main group during the time period of two observations. ASED in the exposed children (main group) is characterized with a permanently higher values compared to the unexposed group (control). Lead, cadmium and mercury urine levels were significantly lower in the control group compared to the main at the time of the first examination. Further, changes in heavy metals urine contents were characterized by a decrease of lead, cadmium and mercury levels in urine in the children of the main group and by an increase of urine lead concentration in the children from the control group (Table 1).

Table 1. Radio-ecological parameters in children of observed groups.

Parameters	Groups			
	Main		Control	
	1 st examination a	2 nd examination b	1 st examination c	2 nd examination d
ASED, mSv	0.770 (0.13-1.297)	0.810 (0.13-2.24)	0.024** (0.017-0.037)	0.034*** (0.017-0.320)
Pb urine excretion, mg/l	0.040 (0-0.359)	0.020* (0-0.076)	0.0172** (0-0.069)	0.028* (0-0.082)
Cd urine excretion, mg/l	0.035 (0-0.159)	0.025 (0-0.053)	0.02** (0-0.08)	0.015 (0-0.041)
Hg urine excretion, mg/l	0.031 (0-0.078)	0.021* (0-0.063)	0.022** (0-0.102)	0.019 (0-0.069)

Note: Minimal and maximal values are shown in brackets.

*- ^{b-a; d-c} (P<0.05) **- ^{c-a} (P<0.05) ***- ^{d-b} (P<0.05)

Clinical findings

Complaints of the examined children

Contents of complaints observed in the examined children are shown in Table 2. The frequency of the children with some kinds of complaints is larger in the main group than in the control both at the first and the second examinations. There is observed a growing tendency of complaints for both groups between the first and the second examinations.

The frequency of astenoneurotic complaints was significantly higher in the main group than in the control during the first examination. In the children of the main group a growing tendency of such complaints was observed with time. In the control group an increased incidence of astenoneurotic complaints was also ascertained at the moment of the second investigation, though it did not get the values observed in the main group.

It should be noted that there were high frequencies of complaints of headaches among the examined children. A significantly higher prevalence with this complaint in the main group was observed as compared with the control, while the incidence of headaches increased in both groups with time.

The number of complaints of heart disturbance significantly increased at the second examination in both groups with a higher prevalence in the main group.

Gastroenterological complaints prevailed among the total structure of complaints. At the time of the second examination, significant increases were observed in the frequency complaints such as belch, heartburn and decreased appetite in both groups. Stomachache was the most frequent complaint.

Clinical syndromes and diagnoses

The data shown in Table 3 give the distribution of major clinical syndromes and diagnoses in the examined children during the both periods of observation.

Table 2. Frequency of complaints in examined children, (%).

Complaints	Groups			
	Main		Control	
	1 st examination a	2 nd examination b	1 st examination c	2 nd examination d
Complaints present	72.2	78.9	45.7**	66.1****
Complaints absent	27.8	21.1	54.3**	33.9****
Weakness	31.6	28.6	11.9**	24.7*
Dizziness	12.8	17.3	4.9**	5.8***
Headache	37.6	45.1	20.7**	25.9***
Syncope	0.8	2.3	0	0
Nasal bleeding	2.3	3.8	0.5	1.2
Fatigability	27.1	23.3	8.2**	17.2*
Irritability	3.0	4.5	1.1	2.9
Troubled sleep	3.0	1.5	0.5	0
Uracrasia	0.8	1.5	0.5	1.7
Heartache	6.8	9.0	13.0	11.5
Heart disturbance (arrhythmia)	1.5	18.8*	0	5.8****
Stomachache	51.9	64.7*	21.2**	44.3****
Belching	9.8	15.8	2.2**	12.6*
Heartburn	1.5	7.5*	1.6	5.8*
Decreased appetite	9.0	14.3	1.1**	10.3*
Diarrhea	2.3	0.8	0.5	0
Constipation	0.8	0.8	1.1	0.6
Allergic eruptions	1.5	3.0	0.5	5.8*

Note : * - b-a; d-c (P<0.05) ** - c-a (P<0.05) *** - d-b (P<0.05)

In the structure of diseases and clinical syndromes, the most prevalent were cardiovascular manifestation of the vegetative dysfunction (vegetovascular syndrome), chronic pathology of the gastrointestinal tract (chronic gastritis, duodenitis and gastroduodenitis), caries, asthenoneurotic syndrome, tonsilla hypertrophy and chronic tonsillitis. A significant increase in the incidence of the combined form of chronic gastrointestinal pathology (chronic gastrodoudenitis) was observed in both groups with its higher prevalence in the main group.

Cardiovascular syndromes and diagnoses are presented in the form of mitral valve prolapse and vegetovascular syndrome including arterial hypertension, arterial hypotension and cardiac syndrome (arrhythmia, metabolic dysfunction, isolated heart murmur). For the arterial hypertension syndrome, the children of both groups were distributed approximately equally. A special attention should be paid to the distribution of children with the arterial hypotension syndrome: during the first examination, the frequency of hypotension in the main group exceeded significantly than in the control group; later on, with age a tendency to a decreased frequency of hypotension was observed only in the control group. An opposite picture was revealed in the main group: the arterial hypotension syndrome increased at the second examination.

In the children suffering from the combined radio-chemical influence the main hemodynamic mechanism of arterial pressure decrease is the insufficiency of the arterial blood vessels tonus. The so-called syndrome of arterial hypotension is caused by the disturbances in the mechanisms of neurohormonal regulation of vascular tonus as a decrease in the catecholamine activity combined with a decrease in the hormonal activity of thyroid gland as a result of iodine deficiency observed in Belarus [20] and the impact of radioiodine released after the Chernobyl accident. Besides, a decrease of serum cAPM level as well as predominance in prostacyclin depressive activity was revealed in the children with

Table 3. Frequency of clinical syndromes and diagnoses in examined children (%).

Clinical syndromes and diagnosis	Groups			
	Main		Control	
	1 st	2 nd	1 st	2 nd
	examination a	examination b	examination c	examination d
Chronic gastritis	44.2	36.4	31.9	32.9
Chronic duodenitis	6.2	4.7	1.5	1.4
Chronic gastroduodenitis	17.1	39.5*	11.6	28.7*
Bilious dyskinesia	43.4	34.1	17.4**	12.6***
Mitral valve prolapse	2.9	4.5	5.4	4.8
Vegetovascular and cardiac syndrome (total):	67.9	73.7	40.3**	52.2*, ***
incl. arterial hypertension	5.9	3.8	5.9	3.2
arterial hypotension	14.2	18.1	6.5**	4.8***
metabolic cardiac dysfunction	14.9	23.3	3.2**	6.9***
arrhythmia	2.2	2.3	0.5	0.5
isolated heart murmur	40.4	33.8	23.1**	35.5*
Asthenoneurotic syndrome	20.2	16.9	7.5**	11.3
Uracrasia	3.2	1.5	1.2	4.2
Tonsilla hypertrophy	19.8	20.0	21.2	16.7
Chronic sinusitis	0	1.5	0	0.6
Adenoiditis	2.4	0	0	3.5
Chronic tonsillitis	11.1	9.2	13.6	17.2***
Caries	58.9	59.4	42.6**	37.3***
Chronic periodontitis	6.8	2.4	0**	0.6
Iron deficient anemia	6.6	3.2	6.9	3.5
Allergic eruptions	2.5	0.8	4.6	1.8

Note *_ b-a; d-c (P<0.05) **_ c-a (P<0.05) ***_ d-b (P<0.05)

hypotension of the main group [21]. Study of the blood vessels functional reactivity in the suffering children confirms a significant decrease of arterial blood vessels tonus and shows the insufficiency in the normal arterial pressure supply. Also significant disturbance of peripheral, cerebral and systemic tonus of arterial vessels has been ascertained on the level of intra systemic relations [22].

During the first examination, the frequency of children with vegetative dysfunction manifestations in the form of cardiac syndrome was significantly lower in the control group as compared with the main one. During clinical follow-up this syndrome increased in both groups, which caused an increased number of complaints of heart disturbances. It should be noted that this increase was mainly due to metabolic cardiac dysfunction both in the main and control groups, as well as due to the isolated systolic murmur in the control group. Metabolic cardiac dysfunction is characterized by a disorder in the phase of ventricle myocardium repolarization of different degree of manifestation [23].

Distribution of the psycho neurological syndromes and diagnoses was characterized by the fact that asthenoneurotic syndrome prevailed in the main group both during the first and second examination, the distinctions being statistically significant in the first case (Table 3).

Relative risk analysis

Epidemiological analysis of the obtained data with the calculation of the relative risk (RR) of the development of the diseases is performed in Table 4.

The obtained data show that both during the first and second examination, the RR values of the development of the diseases were higher in the children from the main group as compared with the control. It mostly concerns arterial hypotension and metabolic form of cardiac syndrome. An increase in the RR of the development of arterial hypotension points the relationship between the observed pathology and its age dynamics, on the one hand, and environmental impact on the children's organism, on the other hand.

Chronic small doses radiation and chemical exposure causes nonspecific disorders in the organism (changes in oxidative processes, decrease in cell membrane stability, attenuation of protective and adaptive mechanisms). The effect of some of them leads to the development of ecological disadaptation syndrome [24] and appearance of clinically signed syndromes and diseases.

According to published data, the effect of environmental pollutants on the health of children makes about 20%, therefore, the health of the population is considered at present as an integral index of the quality of the environment [3-5].

Erythrocyte membranes structural and functional state

Cell membranes are considered to be the initial target of the environmental exposure and pathologic effect of xenobiotics is mediated, first of all, by membranous effects. Universal property of biological

Table 4. Relative risk (RR) of some clinical syndromes and diseases in observed children.

Clinical syndrome and diagnosis	1 st examination	2 nd examination
Chronic gastroduodenitis	1.46 (0.85-2.51) $\chi^2 = 1.49, P < 0.223$	1.40 (1.03-1.90) $\chi^2 = 4.01, P < 0.045$
Arterial hypotension	2.21 (1.11-4.40) $\chi^2 = 4.57, P < 0.03$	3.73 (1.79-7.76) $\chi^2 = 13.19, P < 0.0002$
Cardiac metabolic dysfunction	4.66 (1.92-11.92) $\chi^2 = 12.92, P < 0.0003$	3.33 (1.82-6.13) $\chi^2 = 16.02, P < 0.00006$
Vegetovascular syndrome	1.68 (1.36-2.07) $\chi^2 = 22.14, P < 0.000003$	1.41 (1.19-1.68) $\chi^2 = 14.24, P < 0.0002$

Note: Confidential Interval (CI) is shown in brackets.

membranes is their high sensitivity to the environmental influences. Structural changes in erythrocyte membranes may be indicated both in the lipid bilayer and proteins. At present, it has been ascertained that proteins and lipids jointly participate in structural reformation of biological membranes. Investigation of membranes with the help of lipophilic fluorescent probes makes it possible to judge about the changes in micro viscosity of membrane lipids.

While studying the changes of physical-chemical state of erythrocyte membranes with the help of lipophilic fluorescent probes, it has been shown that fluorescent intensity of the lipophilic probe DPH included into the erythrocyte ghosts was 0.84 ± 0.07 relative units in the children of the main group, which was significantly higher than in the control one (0.66 ± 0.02) ($P < 0.05$) (Figure 1).

A decrease by 18.5% in the value of pyren excimerization coefficient (CEP) included into the erythrocytes ghosts of the children from the main group has been ascertained as compared with the group of children living in the Vitebsk region (control group) (Figure 1).

Stability and rheological properties of plasmatic erythrocyte membranes and parameters of hemoglobin reactions determine the supply of body tissue with oxygen. Erythrocyte membrane provides integration and conformation of red blood cell, controls the flow of metabolites inside the cell and outside, and participates in different intercellular interactions and reactions of the erythrocyte cytoplasm to the outside effects. There exist a large number of biochemical and biophysical mechanisms which determine the relation between the state of plasmatic membranes and components of cytoplasm, and regulate the transmission of signal lengthwise through membrane. Changes in the structural organization, properties and stability of erythrocyte membrane in response to environmental effects plays a regulatory role controlling the state of intra erythrocyte components and acting as a means of erythrocyte adaptation to the changing situation in serum. The obtained data show that physical and chemical state of erythrocyte membranes in children from the main group was characterized by changes in micro viscosity of membranous lipids, which may result from the effect of environmental impact. These changes could be estimated as general biological response of cell membranes of all types for the environmental exposure and play significant unified role in development of disadaptation syndrome and different health disorders and diseases.

Conclusions

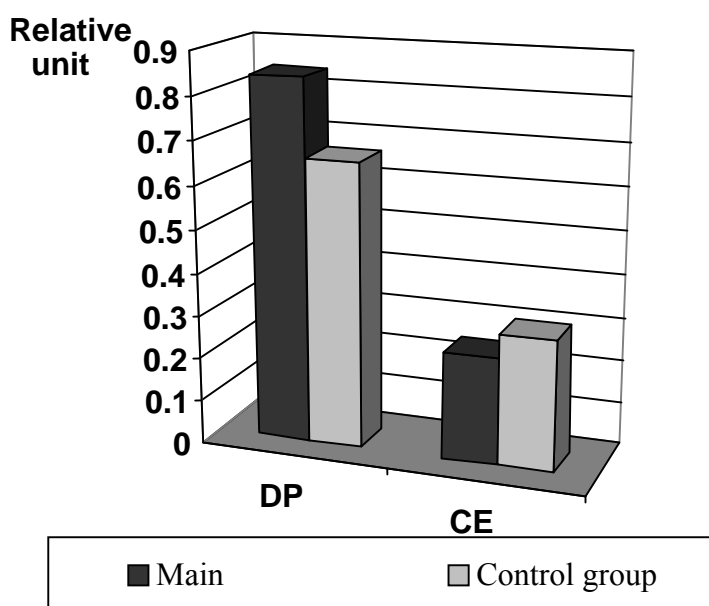

Figure 1. Mean values of lipophilic fluorescent probe 1,6-diphenyl-1,3,5-hexatriene (DPH) and coefficient of excimerization of pyren (CEP) in examined children.

Clinical follow-up of two groups of Belarusian children (the main and the control) clearly indicates an aggravating situation of their health state by both the number of complaints and the number of major clinical syndromes and diagnoses. The most important is the growth of the gastrointestinal pathology, as well as an increase in cardiovascular manifestations of the vegetative dysfunction syndrome.

Practically all forms of studied nosology are more prevalent in the main group compared to the control both at the first and the second examinations. High values of relative risk (RR) are obtained for arterial hypotension (RR=2.21 and 3.73 at the first and the second examination, respectively) and cardiac metabolic dysfunction (RR=4.66 and 3.33).

The present situation requires that measures for correction and prophylaxis of environmental depending pathology should be conducted. These measures should cover all aspects of etiopathogenesis and be directed to restoration of the impaired resistance of the children's organisms using first of all, medication free (medicines free or non medicament) means and methods.

References

1. Astakhova LN, Demidchik EP, Davydova EV et al. Health state of Belarus children and adolescents suffered from the Chernobyl accident. Vestnik of the USSR Academy of Medical Sciences. 1991, N11, P.25-27. (Russian)
2. Erzinkyan KL Anthropogenic factors of the environment and health. Vestnik of the USSR Academy of Medical Sciences. 1989, N8, P.59-68. (Russian)
3. Ilyin VA Problems of medical ecology and health of children and adolescents. Abstract of the Republican conference. Vladivostok, 1991, P.21-23. (Russian)
4. Oleshkevich LA, Sokolov SM Individual sensitivity as the basis of the morbidity risk group formation in the population. In "Modern technologies and human health. Minsk, 1991, P.28-29 (Russian)
5. Shandala MG, Zvinyatzkovskiy YaI Health of population as a criteria of the anthropologic system. In "Methodological problems of human ecology". Novosibirsk, 1988, P.82-85. (Russian)
6. Zhukova OM, Matveenko II, Germenchuk MG Belarus Polesie: radio-chemical contamination and health of the population. Proceedings of the International conference. Minsk, 1988, P.166. (Russian)
7. Gres NA, Polyakova TI Microelement state of human being and the problems of health. In "Microelement disorders and health of Belarus children after the Chernobyl accident", Minsk, 1997, P.5-25. (Russian)
8. Kozarezova TI, Slobozhanina EI et al. State of erythrocyte system in children suffered from the radiation exposure after the Chernobyl accident. In "State of the gematoimmune system in Belarus children after the Chernobyl accident". Minsk, 1996, P.86-89. (Russian)
9. Kozarezova TI, Gres NA et al. State of the erythrocyte system in children with anemia residing in the large industrial center. In "State of the gematoimmune system in Belarus children after the Chernobyl accident". Minsk, 1996, P.63-77. (Russian)
10. IPCS. Lead - environmental aspects. Environmental health criteria 85. WHO, Geneva, 1992.
11. Veltishev YV, Fokeeva VV Ecology and children's health. Maternity and Childhood. 1992, N12, P.30-35. (Russian)
12. Turovets GL, Orlova EV et al. Differential estimation of the environmental factors and health of schoolchildren. Vestnik of the Russian Academy of Medical Sciences. 1993, N6, P.46-50. (Russian)
13. Vasilenko IYa About radioactive cesium. Medical Military Journal. 1989, N5, P.37-39. (Russian)
14. Gres NA, Arinchin AN, Petrova VS Environmental aspects of pediatrics in Belarus. In "Ecological and social problems of protection and control over the health state of young generation on the way to the 21 century". 4th International Congress, St. Petersburg, 1998, P.99-101. (Russian)
15. Monaenkova AM, Zorina LA, Ryzhkova MN About the problem of chronic poisoning of chemicals. Labor hygiene and occupational diseases. 1981, N10, P.4-7 (Russian)
16. Petrenko ZN Ultrastructural characteristics of stomach mucous membrane in human and experimental animals being in the zone of the high radiation exposure after the Chernobyl accident. Abstract of the candidate dissertation. Kiev, 1990, 28 p. (Russian)
17. IPCS. Quality management for chemical safety testing. Environmental health criteria 141. WHO, Geneva, 1992.- 112 p.

18. IPCS. Principles for evaluating chemical effects on the aged population. Environmental health criteria 144. WHO, Geneva, 1993. -159 p.
19. M. Balonov, P. Jacob, I. Likhtarev, V. Minenko. Pathways, levels, and trends of population exposure after the Chernobyl accident // The radiological consequences of the Chernobyl accident. Proceedings of the international conference. Minsk, Belarus, 18-22 March, 1996, EUR 16544 EN, Brussels-Luxembourg, 1996:235-249.
20. Arinchin A., Gembicki M. et al. Goiter Prevalence and urinary iodine excretion in Belarus Children Born after the Chernobyl accident. IDD Newsletter, vol.16, num.1, February, 2000:7-9.
21. Arynchyn AN Blood circulation in children suffered from the combined chronic low doses radio-chemical exposure. Zdravoohranenie. 2000, N2, P.6-10. (Russian)
22. Arynchyn AN Reactivity of cardiovascular system in children suffered from the long term low doses radiation exposure. Zdravoohranenie. 1999, N2, P.9-13. (Russian)
23. Arynchyn AN, Nalivaiko GV Bioelectrical activity of myocardium in children residing in the contaminated with radionuclides territories. Zdravoohranenie Belorussii. 1991, N1, P.4-7. (Russian)
24. Gres NA, Polyakova TI et al. Patomorphosis of choric gastritis in children and adolescents suffered from the combined radio-chemical exposure. In "Patomorphosis of choric gastritis in children and adolescents of Belarus after the Chernobyl accident". Minsk, 1995, P.107-165. (Russian)

Chernobyl Radiation-induced Thyroid Cancers in Belarus

Mikhail V. MALKO

*Joint Institute of Power and Nuclear Research, National Academy of Sciences of Belarus
Krasin Str. 99, Minsk, Sosny, 220109, Republic of Belarus: mvmalko@malkom.belpak.minsk.by*

Abstract

Assessment of incidence and mortality for thyroid cancers carried out for the Belarusian population is described in the present report. It is found that in the period of 1987-2000 about 4,400 radiation-induced thyroid cancers appeared in Belarus: 692 cancers among children and 3,709 cancers among adolescents and adults. The number of lethal thyroid cancers in this period of time in Belarus was assessed as about 350 cases. The excessive absolute risk, EAR, of thyroid cancer incidence assessed for the period of 1987-2000 on the basis of given data on the morbidity and the assessed collective thyroid dose of irradiation is (2.5 – 5.0) per 10^4 PYGy. The EAR value of thyroid cancer mortality is assessed as (0.20 - 0.40) per 10^4 PYGy. The excessive relative risk, ERR, of thyroid cancer incidence is assessed as (11.2 – 22.4)/Gy. The radiation risks of thyroid cancers found in the present report are higher than the risk coefficients established for atomic bomb survivors that were irradiated with dose rates some thousand times higher than populations of Belarus affected by the Chernobyl accident. The absence of marked latency period is another feature of radiation-induced thyroid cancers caused in Belarus as a result of this accident.

INTRODUCTION

As a result of the Chernobyl accident a large amount of radioactive substances escaped from the destroyed reactor. Especially high release was in case of volatile radionuclides. According to the existing assessments about 50% of the ^{131}I isotope inventory came into the environment [1]. This caused the radioactive contamination of many countries of the Northern Hemisphere [2]. However, the main fraction of radioactive materials released by the accident deposited in Belarus. The total amount of the ^{131}I deposited in Belarus is assessed as approximately $3.3 \cdot 10^{17}$ Bq or about 18.5% of the total amount of ^{131}I that escaped from the Chernobyl reactor [3]. Practically the whole territory of Belarus was contaminated with this and other iodine isotopes. This resulted in very high doses delivered to thyroid gland of a large amount of people in Belarus. It is well known that the highest thyroid doses in Belarus were received by the inhabitants of the south districts of the Gomel region and of the southeast districts of the Brest region [4]. According to the data of Yu.Gavrilin et al.[4], the arithmetic mean thyroid dose in the age group 0-6 years of the children living in settlements of the Khoiniki district settled in the 30-km zone was about 4.7 Gy and maximal doses were about 50 Gy. Very high thyroid doses were received also by the inhabitants of Brest and Mogilev regions. This is the reason for a very high increase in the thyroid cancer incidence in Belarus after the Chernobyl accident, especially among the children of Gomel and Brest regions.

V.Kazakov, E.Demidchik and L.N.Astakhova [5] published the first reliable data on the significant increase in the thyroid cancer morbidity among the children of Belarus after the Chernobyl accident. However, specialists met these data with a big skepticism. There were serious reasons for this skepticism. At first, the data of [5] have shown an unusual short latent period of about 2-3 years. At second, no similar data about the increase in the incidence of thyroid cancer among the children of the affected areas of the Ukraine and Russia were known at the time of publication [5]. This was very strange because all specialists believed that the Ukraine was affected by the Chernobyl accident more significantly than Belarus. It is now clear that such assumption was fully incorrect.

In order to explain an unusually high incidence of thyroid cancer among the children of Belarus some specialists proposed an idea that this increase was caused by the improved screening in Belarus [6].

This situation changed only after the First International Conference on the Radiological Consequences of the Chernobyl Accident held in Minsk in 1996 from 18 to 22 March. At the conference new data on the thyroid cancer incidence in Belarus [7] as well as similar data on the increase of the thyroid cancer incidence among the children of the Ukraine [8] and Russia [9] were presented. Data on the thyroid cancer morbidity in these two countries differed only quantitatively from the Belarusian data.

Analysis of the data on the thyroid cancer morbidity in three countries has shown that the highest increase in the thyroid cancer incidence was registered in Belarus and the lowest in Russia. Such difference was explained later on the basis of thyroid doses delivered to inhabitants of the affected areas of Belarus, the Ukraine and Russia. It was shown that the highest irradiation doses of thyroid glands were received in Belarus and the lowest in Russia [3].

At the Minsk conference a number of evidences were given that indicated the association between the increase in the incidence in thyroid cancer among the children of Belarus, the Ukraine and Russia and ionizing origin. For example, it was shown that in Belarus thyroid cancer has mainly appeared in the children irradiated as a result of the Chernobyl accident. It was established that out of the total number of 390 thyroid cancers registered among the children of Belarus in 1986-1994 and the first 7 months of 1995 380 cases were diagnosed for the children born before the Chernobyl accident, 6 cases for the children born at the time of the accident and only 4 cases for the children born after full disintegration of radioiodine [7].

Other very important finding relates to the histological types of thyroid cancers in countries affected by the Chernobyl accident. For instance, more than 90% of thyroid cancer in Belarus and the Ukraine were papillary carcinoma as compared to 68% of the England and Wales tumors [10]. Within the papillary carcinoma over 70% of thyroid cancers in the countries affected by the Chernobyl accident were of the solid follicular type compared to only 40% in England and Wales [10].

At present, practically nobody doubts in the manifestation of radiation-induced thyroid cancers among the children of the affected areas of the former USSR [11]. However, up to the present time nobody recognizes the manifestation of radiation-induced thyroid cancers among adolescents and adults despite of the existence of reliable data indicating the presence of radiation-induced thyroid cancers for other age categories than children [12].

The existence of such controversies requires careful studies of incidences of thyroid cancers by different age categories in order to establish evidences on a link between radiation and the increased morbidity of thyroid cancer. The present report describes the results of an analysis of incidences in thyroid cancers among children, adolescents and adults of Belarus. The excessive absolute risk, EAR, and the excessive relative risk, ERR, were also assessed in the report. Only data established for Belarus were considered because the population of Belarus received the highest thyroid dose [3]. Due to this fact a more clear manifestation of irradiation effects may be expected in Belarus. It is also important that the epidemiological data established in Belarus are more comprehensive and accurate than in Russia and the Ukraine. The present report is practically the further development of our previous studies [13,14].

MATERIALS AND METHODS

Data established by specialists of the *Thyroid Surgery Registry* of the Scientific and Practical Centre for Thyroid Tumors of the Institute of Medical Radiology and Endocrinology of the Ministry for Health Care of the Republic of Belarus [5,7,15-19] as well as data of the Belarusian Cancer Registry [20-28] and other official data [29-34] were used in the present report for an assessment of radiation-induced thyroid cancer in Belarus. Results given in the present report were assessed for the mixed populations of children, adolescents and adults of Belarus. In case of adults no separate consideration of persons involved in

mitigation work of the Chernobyl accident or so-called liquidators was performed. No separate assessment for males and females was also conducted.

Monitoring of malignant neoplasms in Belarus began in 1950s [20-29]. Therefore, quite accurate data exist at least from 1960s. However, until 1994 only sparse information on the incidence and mortality in separate malignant neoplasms was published in the country. These were data on crude incidence and mortality in malignant neoplasms combined together and given for Belarus in total. Beginning from 1994 the Belarusian Cancer Registry publishes annually their statistical books that contain more detailed information on the incidence and mortality in malignant neoplasms. This information is given for Belarus in total as well as for separate administrative units of the country. Belarus is divided in 7 administrative units: 6 regions (Brest, Vitebsk, Gomel, Grodno, Minsk, Mogilev) and the Minsk city which is the capital of the country [29-34]. The smallest administrative unit is the Mogilev region with 1.2 million of people. The largest unit is the Minsk city with the number of inhabitants about 1.7 million [29-34].

The excessive absolute risk, EAR , was estimated with the simplified expression:

$$EAR = (O - E) / N_{PYsv} . \quad (1)$$

Here O – observed number of thyroid cancer; E – expected number of thyroid cancer; N_{PYsv} – number of person·year·sievert under risk.

The value of N_{PYsv} was assessed on the basis of equation:

$$N_{PYsv} = H_{Th}^{coll} \cdot Y . \quad (2)$$

Here H_{Th}^{coll} – collective thyroid equivalent dose delivered in 1986; Y – number of years under risk after the accident.

The excessive relative risk, ERR , was calculated by using of the expression:

$$ERR = (O / E - 1) / \bar{H}_{ind} . \quad (3)$$

Here \bar{H}_{ind} – average individual dose of irradiation.

The value of \bar{H}_{ind} can be determined with the formula:

$$\bar{H}_{ind} = H_{Th}^{coll} / N . \quad (4)$$

Here N is the number of people with irradiated thyroid glands.

RESULTS AND DISCUSSION

Morbidity of thyroid cancers among children of Belarus

Thyroid cancer is a quite rare disease for children. According to the data of the *Thyroid Surgery Registry* [15] in 1966-1985 (or during 20 years) only 21 cases of thyroid cancers were registered in the children of Belarus. This gives 1 case of thyroid cancer per year as a spontaneous morbidity of thyroid cancer for the Belarusian children. The average number of children (less than 15 years old) in Belarus in the pre-accidental period was about 2.37 million [29-34]. As can be calculated from this figures, the spontaneous morbidity of thyroid cancer for the children of Belarus before the Chernobyl accident was approximately 0.4 cases per million. This value is very close to the spontaneous morbidity of thyroid cancer in the children of England and Wales [10] equal to approximately 0.5 cases per million. Data in Table 1 taken from [17] demonstrate that before the Chernobyl accident only 3 possibilities were registered as the number of thyroid cancer incidence among the children. They were 0, 1 and 2 cases per year. This means that the highest number of spontaneous thyroid cancers among the children of Belarus is equal to 2 cases in a year and the spontaneous incidence rate in thyroid cancers for the children of Belarus is 1 ± 1 cases in a year.

The situation changed after the Chernobyl accident. Table 2 contains the numbers of thyroid cancers registered annually in 1986-1997 [16]. Already in 1987, 4 cases of thyroid cancers were registered in the

Belarusian children. This number is by a factor of 2 higher than the maximal possible number of spontaneous cases that can realize annually. The data in Table 2 demonstrate practically an absence of the latency period for radiation-induced thyroid cancers among the children of Belarus. The first radiation-induced thyroid cancers among them, according to Table 2, manifested already in 1987 or 1 year after the Chernobyl accident. This finding was unexpected for the majority of scientists because the believing in the existence of the latency, at least 5 years long, was the common wisdom of radiation biology.

As can be seen from Table 2, the highest increase in the incidence of thyroid cancers among children manifested in Gomel (53.1%) and Brest (23.5) regions and the lowest in Vitebsk region. These findings correlate with the level of contamination of different Belarusian regions with iodine isotopes discharged to the environment by the Chernobyl accident [35].

Our assessment demonstrates that 692 additional thyroid cancers in the children of Belarus were registered in 1987-2000 (see Table 3). The numbers of observed thyroid cancers in children in 1987-1997 were taken from the last row of the previous table.

The numbers of observed thyroid cancers in children in 1998-2000 were established by [19].

Data given in Tables 2 and 3 as well as in Fig. 1 show that the incidence in thyroid cancers among the children of Belarus increased monotonously from 4 cases in 1987 to 91 cases in 1995, and then decreased also monotonously to 31 cases in 2000.

The reason for the decline in thyroid cancers incidence after 1995 is very easy. It is caused simply by the medical statistics used in Belarus [13,14]. All official data on cancer morbidity in Belarus are given for two groups. The first group includes the data for those persons for which cancers as well as thyroid cancer are diagnosed when they are less than 15 years old. The second group includes all persons that are older than 15 years. Thus, when a person reaches 15 years at the time of the thyroid cancer diagnose, this person will be considered as a person belonging to the group of adolescents and adults. This means that there is a permanent transition from the subgroup of children to the subgroup of adolescents and adults. As a result of this transition, the children that received thyroid doses by the Chernobyl accident are being lost

Table 1. Incidence of thyroid cancer among children of Belarus before the Chernobyl accident.

Year	Male	Female	Both	Year	Male	Female	Both
1971	0	0	0	1979	0	0	0
1972	0	0	0	1980	0	0	0
1973	1	1	2	1981	0	1	1
1974	0	2	2	1982	1	0	1
1975	0	1	1	1983	0	0	0
1976	2	0	2	1984	0	0	0
1977	1	1	2	1985	0	2	2
1978	0	1	1	1986	1	1	2

Table 2. Thyroid cancer among children of Belarus after the Chernobyl accident [16].

Region/Year	86	87	88	89	90	91	92	93	94	95	96	97	Total
Brest	0	0	1	1	7	5	17	24	21	21	25	13	135
Vitebsk	0	0	0	0	1	3	2	0	1	0	0	0	7
Gomel	1	2	1	3	14	43	34	36	44	48	42	37	305
Grodno	1	1	1	2	0	2	4	3	5	5	5	3	32
Minsk	0	1	1	1	1	1	4	4	6	1	5	6	31
Mogilev	0	0	0	0	2	3	1	7	4	6	3	4	30
Minsk-city	0	0	1	0	4	2	4	5	1	10	4	3	34
Belarus total	2	4	5	7	29	59	66	79	82	91	84	66	574

Table 3. Incidence of thyroid cancers among children of Belarus after the Chernobyl accident.

Year	Observed	Expected	Observed - Expected	SIR
1987	4	1	3	4
1988	5	1	4	5
1989	7	1	6	7
1990	29	1	28	29
1991	59	1	58	59
1992	66	1	65	66
1993	79	1	78	79
1994	82	1	81	82
1995	91	1	90	91
1996	84	1	83	84
1997	66	1	65	66
1998	54	1	53	54
1999	49	1	48	49
2000	31	1	30	31
1987-2000	706	1	692	50.4

permanently from the children’s subgroup. This transition causes the decrease in the incidence in thyroid cancers among the children of Belarus with the time.

Thus, in order to establish real incidence rates of thyroid cancers for the children of Belarus one needs to determine the number of irradiated children in the children’s subgroup. Such data are given in the third column of Table 4. It is seen from this table that the number of irradiated children in Belarus decreased from 2.303 million in 1986 down to 0.223 million in 2000.

The last group of the children with thyroid doses caused by iodine isotopes will move to the subgroup of adolescents and adults in the first 3 months of 2001. This group will include only the children that were irradiated *in utero*. It means that beginning from 2002 the incidence of thyroid cancers among the children of Belarus will be the same level as before the Chernobyl accident, or 1 case annually.

For forecasting the number of thyroid cancers for 2001, the simplified procedure described in our previous publication [14] was used. It is based on a linear extrapolation between 2000 and 2002. The data

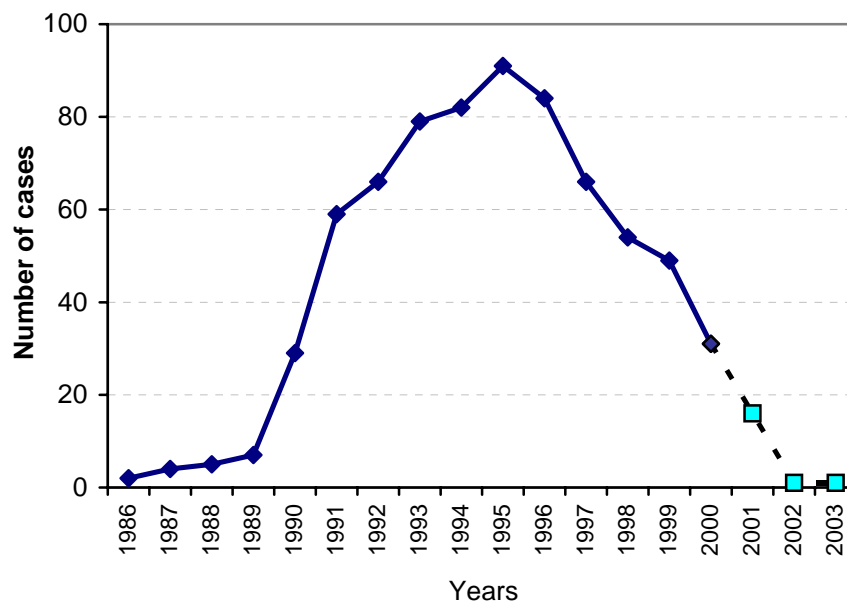

Fig. 1. Number of thyroid cancer incidence among the children of Belarus.

Table 4. Assessment of the incidence rates of thyroid cancers among children of Belarus after the Chernobyl accident.

Year	Total amounts of children (in millions)	Amounts of irradiated children (in millions)	Observed	Observed-Expected	Incidence rate (per 100,000 children)
1986	2.303	2.303	2	1	0.0434
1987	2.315	2.152	4	3	0.1394
1988	2.325	1.999	5	4	0.2001
1989	2.337	1.858	7	6	0.3229
1990	2.337	1.715	29	28	1.6327
1991	2.335	1.581	59	58	3.6686
1992	2.328	1.446	66	65	4.4951
1993	2.327	1.328	79	78	5.8735
1994	2.307	1.198	82	81	6.7669
1995	2.273	1.062	91	90	8.4746
1996	2.217	0.910	84	83	9.1209
1997	2.154	0.758	66	65	8.5752
1998	2.086	0.597	54	53	8.8777
1999	1.961	0.379	49	48	12.6649
2000	1.898	0.223	31	30	13.4529

given in [28] shows that 31 cases of thyroid cancers were registered in 2000. Linear extrapolation between 31 cases in 2000 and 1 case in 2002 gives 16 thyroid cancers in 2001 for the children of Belarus. This value is used in constructing Fig. 2.

The total number of thyroid cancers in the Belarusian children that can manifest in the period from 1986 up to 2002 will be then equal to 722 cases. Subtraction from this number of the number of spontaneous thyroid cancers that have to appear in 1987-2001 (15 cases) will give the number of radiation – induced thyroid cancers among the children of Belarus equal to 707 cases.

At the same time, we have to expect some contribution to the additional thyroid cancers that were caused as a result of irradiation of their thyroid glands by other isotopes than isotopes of iodine. This effect can give in reality some higher numbers of thyroid cancers in the children of Belarus after 2001 than

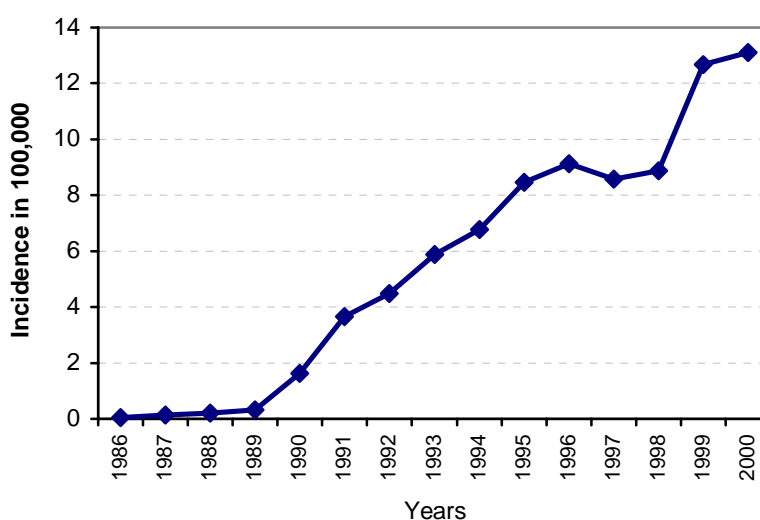

Fig. 2. Incidence rates of thyroid cancer among irradiated children of Belarus.

the spontaneous incidence before the accident. However, this number can not differ very strong from the forecasted number of 707 cases.

As can be seen from Fig. 2, the incidence rate of thyroid cancers in the children of Belarus increases practically linearly after the Chernobyl accident. It increased from 0.0434 cases per 100,000 children in 1987 up to 13.5 cases per 100,000 children in 2000 or by a factor of 310 (see the last column of Table 4). For calculation of incidence rates of thyroid cancers given in the last column of Table 4, the numbers of children in the third column and the numbers of additional thyroid cancers in the fifth column were used.

Assessment of the incidence rate of thyroid cancers in the children of Belarus carried out on the population data presented in the second column of Table 4 gives for 2000 1.58 cases per 100,000 children. This number is 8.5 times less than the real incidence rate of thyroid cancers in 2000 among the children affected by the Chernobyl accident. It is clear that the method of medical statistics used in Belarus gives an apparent decrease of thyroid cancers manifested in children after 1995. This apparent decrease is caused by the transition of persons that reach 15 years to the sub-population of adolescents and adults. We assessed that in 1996-2000 approximately 400 cases of thyroid cancers manifested in persons that were less than 15 years at the time of the Chernobyl accident went to the sub-population of adolescents and adults of Belarus. We assessed this number of thyroid cancers (400 cases) by use of the following expression:

$$Y=13.5 \cdot T - 26,833 \quad (5)$$

It was developed on the basis of incidences of thyroid cancers in the children of Belarus in 1989-1996 by using of the least square method.

Addition of 400 cases to 706 cases (see the last value in the second column of Table 3) gives the approximate total number of thyroid cancers manifested in Belarus in 1987-2000 in those persons that were children at the time of the Chernobyl accident. It is equal to 1106 cases instead of 706 cases considered by specialists. This simplified analysis demonstrates what incorrect conclusions can be drawn about the development of the morbidity of thyroid cancers in the children of Belarus.

Morbidity in thyroid cancers among adolescents and adults of Belarus

The described above transition of the children with thyroid doses from the children's subgroup into subgroup of adolescents and adults decreases the number of radiation-induced thyroid cancers among the persons that are considered as children according to rules of the medical accounting. At the same time this transition causes an additional increase in the incidence in thyroid cancers by adolescents and adults of Belarus after the accident. However, the transition between different subgroups can not explain a very high increase in the incidence of thyroid cancers among adolescents and adults of Belarus after the Chernobyl accident (see Fig.3). The upper curve in Fig.3 presents the registered number of thyroid cancers in adolescents and adults. Here the data for 1977 –1997 were taken from [7,16]. The observed numbers of thyroid cancers in 1998-2000 were estimated on the basis of the data of the Belarusian Cancer Registry [26-28].

According to [26] the incidence of thyroid cancer among the Belarusian population was 7.5 cases per 100,000 persons in 1998 and the total number of people in Belarus was 10.2 million. By using these data one can calculate the number of thyroid cancers registered in Belarus in 1998 equal to 765 cases. This number is a sum of thyroid cancers in children and in adolescents and adults. Subtraction of the number of children's cancers (54 cases in 1998 [17]) from the total numbers of thyroid cancers gives the number of thyroid cancers in adolescents and adults equal to 711 cases. This value is shown in the second column of Table 6. The similar method was used for assessment of number of thyroid cancers registered by adolescents and adults of Belarus in 1999 and 2000.

Two other curves in Fig.3 give assessed spontaneous or expected cases in the group of adolescents and adults of Belarus.

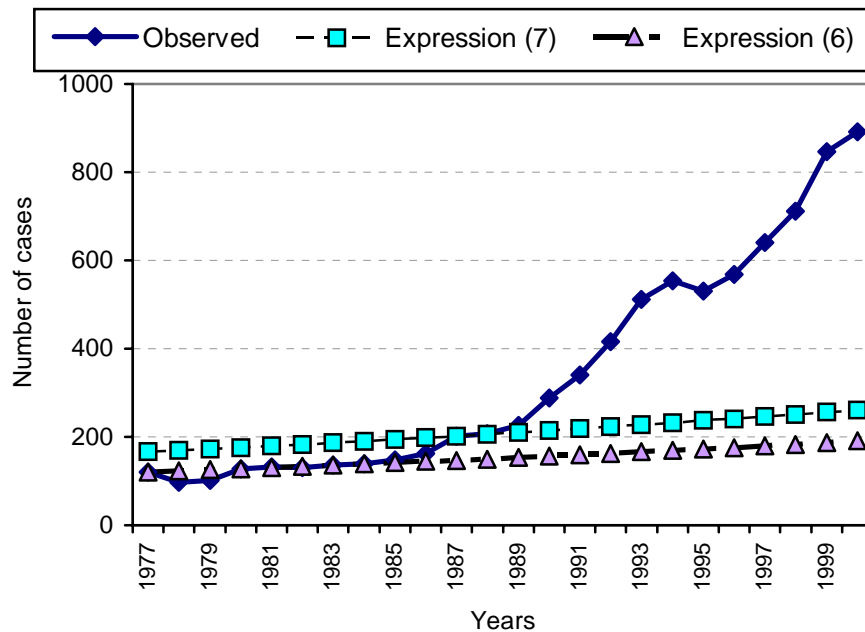

Fig. 3. Incidence of thyroid cancers among adolescents and adults of Belarus in 1977-2000 (absolute numbers).

The expected numbers of thyroid cancers in adolescents and adults of Belarus combined together can be assessed by using of the formula [13]:

$$E_j = E_0 \cdot (1+a)^j, \quad (6)$$

Where E_0 = spontaneous morbidity of adolescents and adults in 1977;

a = is a constant showing the annual increase in the incidence of the thyroid cancer, it is about 0.02 (2% increase annually);

j = is the number of the consequent year beginning with $j=0$ for 1977 ($j=1$ for 1978 and so on);

E_j = spontaneous morbidity of adolescents and adults in the year j .

Data calculated with this expression are presented in Fig.3 (the lower line in figure).

The last expression was established in [13] on the basis of data on thyroid cancer incidences in adolescents and adults of Belarus [7] that were registered before the Chernobyl accident. It was used for calculation of the expected numbers of thyroid cancers among adolescents and adults of Belarus that are also shown in the third column of the Table 5.

Comparison of the data calculated by using of the expression (6) with the observed data presented in the second column of Table 5 demonstrates a very good agreement for 1977-1985 and a quite significant disagreement for 1986 and 1987. We believe that inefficient screening of thyroid cancers among adolescents and adults before the Chernobyl accident causes this disagreement. The following arguments support this idea.

As can be seen from Table 5, the number of registered thyroid cancers in adolescents and adults abruptly increased in 1986 and 1987, and then changed only very insignificant from 1987 to 1988. The probable reason for such change in the incidence in thyroid cancers among adolescents and adults of Belarus can be a more careful investigation of this category of people by specialists or an improved screening.

Table 3 demonstrates that in case of children a clear manifestation of additional thyroid cancers began in 1987 and a marked increase in the incidence occurred only from 1990 or 3 years after the Chernobyl accident. It is difficult to believe that in a case of adolescents and adults a significant manifestation of radiation-induced thyroid cancers began already in 1986. In order to correct the possible effect of inefficient screening in a case of adolescents and adults we modified the expression (6) by inserting of the coefficient c that takes into account the screening effect. This modified expression is given

below:

$$E_j = E_0 \cdot c \cdot (1+a)^j, \quad (7)$$

We determined the coefficient c by dividing of the observed number in 1987 of thyroid cancers in adolescents and adults by the number calculated with the expression (6). By correcting this way the expected incidences of thyroid cancers in adolescents and adults are shown in the fourth column of Table 5. The middle curve in Fig. 3 presents values calculated with the last expression.

We applied the same method for the possible screening effect to assessment of spontaneous morbidity of thyroid cancers in adolescents and adults of Belarus for the whole period after the Chernobyl accident. The corrected numbers of expected thyroid cancers among this category of the Belarusian population are given in the third column of Table 6.

Data on numbers of thyroid cancers registered by adolescents and adults of Belarus in 1986 – 1997 given in the second column of Table 6 were taken from the report of [16]. The number of thyroid cancers in this column for 1998-2000 were calculated on the basis of the morbidity rate in thyroid cancer of the whole Belarusian population and a number of people in the country that are presented in the reports of the

Table 5. Incidence of thyroid cancers among adolescents and adults of Belarus in 1977-1988.

Year	Observed	Calculated values	
		Expression (6)	Expression (7)
1977	121	121	166
1978	97	123	169
1979	101	126	172
1980	127	128	176
1981	132	131	179
1982	131	134	183
1983	136	136	187
1984	139	139	190
1985	148	142	194
1986	162	145	198
1987	202	147	202
1988	207	160	206

Table 6. Incidence of thyroid cancers among adolescents and adults of Belarus after the Chernobyl accident.

Year	Observed	Expected	Observed-Expected	SIR
1987	202	202	0	1
1988	207	206	1	1.005
1989	226	210	16	1.076
1990	289	214	75	1.350
1991	340	219	121	1.552
1992	416	223	193	1.865
1993	512	227	285	2.256
1994	553	232	321	2.384
1995	531	237	294	2.241
1996	568	241	327	2.357
1997	641	246	395	2.606
1998	711	251	460	2.833
1999	847	256	591	3.309
2000	891	261	630	3.414
1987-2000	6934	3225	3709	2.150

Table 7. Additional incidence of thyroid cancers in Belarus in 1987-2000.

Year	Children	Adolescents and adults	All ages
1987	3	0	3
1988	4	1	5
1989	6	16	22
1990	28	75	103
1991	58	121	179
1992	65	193	258
1993	78	285	363
1994	81	321	402
1995	90	294	384
1996	83	327	410
1997	65	395	460
1998	53	460	513
1999	48	591	639
2000	30	630	660
1987-2000	692	3709	4401

Belarusian Cancer Registry [26-28].

As can be seen from Table 6, the first radiation-induced thyroid cancer in the group of adolescents and adults of Belarus, according to our assessment, manifested already in 1988 or 2 years after the Chernobyl accident. This means that the minimal latency period of radiation-induced thyroid cancers by this category is about 2 years and not 10 years later as could be expected on the basis of an experience accumulated previously.

The early manifestation of radiation-induced thyroid cancers in Belarus shows clear an absence of the significant latent period in radiation-induced thyroid cancer in Belarus. This is not surprising. Such possibility was forecasted a long time ago by J.Gofman [36]. He stated in his book "Radiation and Human Health" [36] that the latent period of some cancers can depend on the number of persons in the group under study. In a case of a small group it can be required very long time in order to get provable difference with a control group. On the contrary, in a case of very large group of irradiated persons the provable difference can be reached in a very short time. Such situation had the place in Belarus where about 10,000,000 persons were irradiated.

The total number of additional thyroid cancers among adolescents and adults manifested in Belarus in 1987 - 2000 calculated by using the method described here is equal to 3,709 cases (see Table 6).

Assessment of additional thyroid cancers in Belarus

Table 7 contains the numbers of additional thyroid cancers manifested in Belarus in 1987-2000 estimated in previous sections of the present report. The total number of additional thyroid cancers appeared in the country after the Chernobyl accident is 4,401: 692 cases in children and 3,907 cases in adolescents and adults.

Mortality from radiation-induced thyroid cancers in Belarus

The similar procedure as used by assessment of the thyroid cancer incidence can be used for assessment of the number of people in Belarus that died from thyroid cancer caused by the Chernobyl accident.

Fig. 4 shows the dynamic in the crude mortality rate resulted from the morbidity in thyroid cancers. The data shown in this figure were taken from the reports of the Belarusian Cancer Registry [20-28]. They give the mortality of thyroid cancers for the whole Belarusian population (children, adolescents and

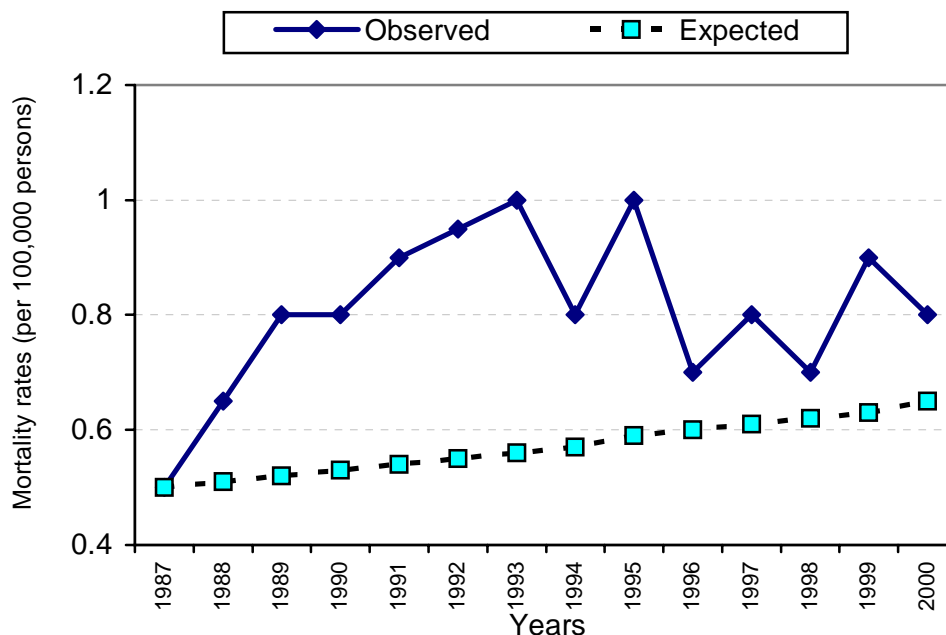

Fig. 4. Mortality rates of thyroid cancers in the Belarusian population.

adults) determined as a number of cases in 100,000 persons. The upper (solid) line gives the observed mortality rates. The lower (dotted) line shows the “spontaneous” mortality rates determined by us. We assessed the “spontaneous” mortality assuming that the mortality rate in 1987 did not differ from the spontaneous mortality and that the annual increase in the spontaneous mortality was in 1987-2000 approximately 2%. Using these data as well as the data on the number of people in Belarus in 1986-2000 [29-34] we assessed the additional number of fatal thyroid cancers in 1987-2000 as approximately 351 cases.

Radiation risks

Excess absolute risk (EAR) for thyroid cancer incidence:

The value of H_{Th}^{coll} equal to $127 \cdot 10^4$ man·Gy was given as the total collective thyroid dose for the Belarusian population in our previous report [3]. The assessment of the collective equivalent thyroid dose in the report [3] was carried out assuming the ratio of activities of ^{131}I to ^{137}Cs (recalculated on the 26 April of 1986) in Belarus equal to 20. This is derived from the data on the total discharge of ^{131}I and ^{137}Cs in the environment [3]. In present report we used the corrected value of H_{Th}^{coll} equal to $121 \cdot 10^4$ man·Gy.

However, new experimental data [36] established on the basis of the isotope ^{129}I demonstrates a possibility of incorrectness of the data on release of the isotope ^{131}I accepted in the report [3]. The authors [37] give a value of the ratio of activities of ^{131}I to ^{137}Cs (recalculated on the 26 April of 1986) equal to 10 ± 3.1 . The collective equivalent thyroid dose assessed using this value is equal to $60.5 \cdot 10^4$ man·Gy. The last value of H_{Th}^{coll} can be considered as the lower limit of the collective equivalent thyroid dose of the Belarusian population caused by the Chernobyl accident. It is by a factor of 2 less than the value of H_{Th}^{coll} equal to $121 \cdot 10^4$ man·Gy, which can be considered as the upper limit of the collective equivalent thyroid doses of the Belarusian population. The real value of H_{Th}^{coll} can be between these two assessments.

Inserting these values and the number of additional thyroid cancers that was assessed in this work (4,401 cases) into the expression (1) gives the value of EAR for the incidence of additional thyroid cancers in Belarus in 1987-2000 to be $(2.5-5.0)/10^4$ PYGy.

This value of the excessive absolute risk agrees quite well with EARs established in other studies.

For example, according to [37], the value of EAR for inhabitants of the Marshall Islands, which had a strong internal irradiation of thyroid gland, is estimated as 1.1 per 10^4 PYGy [38]. In the study of consequences of the Utah ^{131}I fallout [39] the value of EAR equal to 3.3 per 10^4 PYGy was evaluated. According to [40], the excessive absolute risk of radiation-induced thyroid cancers established for mixed population of atomic bomb survivors is 1.1 per 10^4 PYGy (95% CI=0.55-1.75).

The last value is by factor 2-4 less than the excessive absolute risk of radiation thyroid cancers assessed in this report for the Belarusian population. This discrepancy can not arise from an overestimation of the number of additional thyroid cancers or from an underestimation of the collective dose of thyroid gland irradiation used in the present report. We draw this conclusion because our value of the excessive absolute risk is in a qualitative agreement with the value of EAR established for Russian liquidators [12]. According to Ivanov et al [12], the excessive absolute risk of radiation-induced thyroid cancers estimated for this category of irradiated people for period of 1986-1995 is 1.31 per 10^4 PYGy (95% CI=0.55-1.75). The last value is by factor 1.8-3.6 less than our values of the EAR and close to the value established for atomic bomb survivors. However, Russian liquidators form a special group of people, 93 % of which consist of males that were in average 33.4 years old during their period of duty in the 30-km zone [12]. Therefore, the excessive absolute risk of a mixed population that contains approximately equal fractions of males and females has to be at least 2 times higher than the excessive absolute risk established by Ivanov et al [12] for Russian liquidators.

Thus the high value of the EAR assessed in the present report for the Belarusian population is quite reasonable. This is an unexpected result because it is generally accepted that radiation risks of cancers decline with decrease of dose rates. The hypothesis about existence of such dependence between radiation risks and dose rates was proposed in 1980 by the USA National Council on Radiation Protection and Measurements (NCRP) [41]. In order to take into account this effect the NCRP introduced a special dose-rate-effectiveness factor (DREF). According to the NCRP assessment, values of DREF vary from 2 to 10 for different types of cancers. The United Nations Scientific Commission on Effects of Radiation (UNSCEAR) [42] and the International Commission on Radiological Protection (ICRP) [43] also recognize reduction in a carcinogenic efficiency of ionizing radiation by decrease of a dose rate of irradiation. As an evidence of this effect in case of radiation-induced thyroid cancers, the ICRP considers the findings of Holm [44]. This author showed that a chronic irradiation of thyroid gland with ^{131}I is 4 times less effective than acute irradiation with x-rays.

The irradiation of thyroid gland of atomic bomb survivors occurred in approximately 1 minute. In case of liquidators of the Chernobyl accident as well as populations of the former USSR that were affected by this accident the irradiation of thyroid gland lasted at least 1 month or 43,000 minutes. This means that dose rates of the thyroid gland irradiation of liquidators and affected populations of the Soviet Union were about 40,000 times less than dose rates in case of atomic bomb survivors. It is clear that in case of correctness of the NCRP hypothesis the values of EAR for the Belarusian population and liquidators have to be less than the EAR value for atomic bomb survivors. Our data and the data of [12], however, demonstrate a fully disagreement with this expectation. Such disagreement is not the unique feature of radiation-induced thyroid cancers in Belarus. Ivanov et al [45,46] found that radiation risks of solid cancers other than thyroid cancers for Russian liquidators are also by some factors higher than in case of atomic bomb survivors. The authors [45,46] carried out their study by using the cohort method similar to the method used by specialists of the Radiation Effects Research Foundation (RERF) and are quite reasonable. Similar findings were also found in the report [47].

Excess relative risk (ERR) for thyroid cancer:

By using the data on observed and expected incidences of thyroid cancers in children, adolescents and adults, the averaged value of the excessive relative risk, ERR, was also assessed on the basis of

expression (3). The values of O and E were obtained from the data shown in Tables 3 and 6. The value of \bar{H}_{ind} was calculated by inserting the collective equivalent dose of the thyroid cancer irradiation of the Belarusian population H_{Th}^{coll} equal to $(60.5-121) \cdot 10^4$ man·Gy into expression (4) and the number of population in Belarus equal to 10 millions of people. Thus, the ERR value of $(11.2-22.4)/\text{Gy}$ was obtained for the mixed population in Belarus.

The assessed value of ERR is one order in magnitude higher than the value $0.84/\text{Gy}$ established for atomic bomb survivors [40]. However, it agrees very well with the excessive relative risk found for children and adolescents of the affected areas of Belarus, the Ukraine and Russia in the report [48]. According to authors [48], the excess relative risk per unit dose in the study area is equal to $90/\text{Gy}$. One needs to remember that the ERR value for children and adolescents is by some factors higher than for the mixed population. Therefore, we can state that the excess relative risk assessed in our report for the mixed Belarusian population agree quite well with the data of authors [48]. This allow us to conclude that our value of the ERR for the incidence of radiation-induced thyroid cancers in Belarusian population is quite accurate.

Excess absolute risk (EAR) for thyroid cancer mortality:

The excessive absolute risk of mortality resulting from the radiation-induced thyroid cancers was also assessed. The same method as in case of the incidence in radiation thyroid cancers was used for this purpose. It was found that the excessive absolute risk of mortality in radiation-induced thyroid cancers for the Belarusian population is equal to $(0.20-0.40)$ per 10^4 PYGy.

This value agrees quite well with the excessive absolute risk of the death from radiation-induced thyroid cancer assessed by E.Gilbert [49]. The EAR of this author is about $0.125 - 0.25$ per 10^4 PYGy. However, the quality of our assessed data on mortality from radiation-induced thyroid cancers is not so good as in case of data on the incidence in thyroid cancers. Therefore, we consider our assessment on the mortality for radiation thyroid cancers in Belarus as a qualitative assessment.

CONCLUSIONS

1. The morbidity and the mortality from radiation-induced cancers in Belarus as a result of the Chernobyl accident have been assessed for the period of time 1987-2000. According to our assessment, 692 radiation-induced thyroid cancers among the children of Belarus appeared in 1987-2000. The total number of children's thyroid cancers that will manifest in 1987-2001 can be about 707 cases. The number of the radiation-induced thyroid cancers manifested among adolescents and adults of Belarus in 1987-2000 as a result of the Chernobyl accident was assessed as 3,709 cases. The total number of radiation-induced thyroid cancers appeared in this period of time is about 4,401 cases. The number of the people that died in Belarus in 1987-2000 from radiation-induced cancer was assessed as 351 cases.
2. The low latency period of radiation-induced thyroid cancers among the Belarusian population was found: about 1 year in case of children and about 2 years in case of adolescents and adults.
3. The excessive absolute risk, EAR, of the radiation-induced thyroid cancers manifested in Belarus after the Chernobyl accident is assessed as $(2.4 - 4.8)$ per 10^4 PYGy. This value is higher than the excessive absolute risk established for atomic bomb survivors that were irradiated with dose rates many thousands times higher than dose rates of the Belarusian population.
4. The excessive relative risk, ERR, of the incidence in radiation-induced thyroid cancers manifested in Belarus after the Chernobyl accident is assessed as $(11.2-22.4)/\text{Gy}$. These values are one order higher than the excessive relative risk established for atomic bomb survivors.
5. The high value of the radiation risks of the thyroid cancers incidence as well as the absence of significant latency of radiation-induced thyroid cancers by the Belarusian population indicate an

irrelevancy of radiation risks established from atomic bomb survivors for the Belarusian population.

6. The excessive absolute risk of the mortality in Belarus in 1987-2000 from the radiation-induced thyroid cancers was assessed as (0.20 - 0.40) per 10^4 PYGy.

ACKNOWLEDGMENT

The author of the paper expresses his acknowledgment to Dr. Nadya Ryabakon for the assistance in preparing of the manuscript.

REFERENCES

1. Ministry for Chernobyl. *Ten years after the accident at the Chernobyl NPP*. National Report of the Ukraine. 1996. Kiev, Ukraine. 1996, p.2-10 (in Russian).
2. United Nations Scientific Committee on the Effects of Atomic Radiation. *Sources and effects of Ionizing Radiation*. UNSCEAR 1988 Report to the General Assembly, with annexes. United Nations. New York.1988, p.314.
3. Malko, M.V. *Assessment of the Chernobyl radiological consequences*. In the report; Research activities about radiological consequences of the Chernobyl NPS accident and social activities to assist the sufferers by the accident. Edited by Imanaka T. Research Reactor Institute. Kyoto University, Japan. KURRI-KR-21. ISSN 1342-0852, 1998, p.84.
4. Gavrilin, Yu.I, Krouch, V.T., Shinkarev, S.M., Krysenko, N.A., Skryabin, A.M., A.Bouville, A., Anspaugh, L.R. *Chernobyl accident: reconstruction of thyroid dose for inhabitants of the Republic Belarus*. Health Physics. February 1999, v.76, N2, pp.105-119.
5. Kazakov, V.S., Demidchik, E.P., Astakhova, L.N. *Thyroid cancer after Chernobyl*. Nature, 1992, v.359, p.21.
6. Ron, E., Lubin, J., Schneider, A. *Thyroid cancer incidence*. Nature. 1992, v.360, p.113.
7. Demidchik, E.P., Drobyshchanskaya, I.M., Cherstvoy, E.D., Astakhova, L.N., Okeanov, A.E., Vorontsova, T.V., Germenchuk, M.G. *Thyroid cancer in children in Belarus*. Proceedings of the first international conference «The radiological consequences of the Chernobyl accident» held in Minsk, Belarus, in 1996 from 18 to 22 March. Edited by Karaoglou, A., Desmet, G., Kelly, G.N. and Menzel, H.G. EUR 16544 EN. Brussels-Luxembourg. 1996, pp.677-682.
8. Tronko, N., Bogdanova, T., Komissarenko, I., Bolshova, E., V.Oleinik, V.Tereshchenko, Epshtein, Y., Chebotarev, V. *Thyroid cancer in children and adolescents in Ukraine after the Chernobyl accident*. Proceedings of the first international conference «radiological consequences of the Chernobyl accident» held in Minsk, Belarus, in 1996 from 18 to 22 March. Edited by Karaoglou, A., Desmet, G., Kelly, G.N. and Menzel, H.G. EUR 16544 EN. Brussels-Luxembourg. 1996, pp.683-690.
9. Tsyb, A.F., Parshin, M. V., Shakhtarin, V., Stepanko, V.F., Skvortsov, V.F., Chebotareva, I.V. *Thyroid cancer in children and adolescents of Bryansk and Kaluga Regions*. Proceedings of the first international conference »The radiological consequences of the Chernobyl accident» held in Minsk, Belarus, in 1996 from 18 to 22 March. Edited by Karaoglou, A., Desmet, G., Kelly, G.N. and Menzel, H.G. EUR 16544 EN. Brussels-Luxembourg. 1996, pp.691-697.
10. Williams, E.D., Cherstvoy, E., Egloff, B., Holer, H., Vecchi, G., Bogdanova, T., Bragarnik, M. Tronko, N.D. *Interaction of pathology and molecular characterization of thyroid cancers*. Proceedings of the first international conference «The radiological consequences of the Chernobyl accident» held in Minsk, Belarus, in 1996 from 18 to 22 March. Edited by Karaoglou, A., Desmet, G., Kelly, G.N. and Menzel, H.G. EUR 16544 EN. Brussels-Luxembourg. 1996, pp.699-714.
11. United Nations Scientific Committee on the Effects of Atomic Radiation. *Sources and effects of Ionizing Radiation. Annex J: Exposures and effects of the Chernobyl accident*. United Nations. New York. 2000.
12. Ivanov, V.K., Tsyb, A.F., Gorsky, A.I., Maksyutov, M.A., Rastopchin, E.M., Konogorov, A.P., Korelo, A.M., Biryukov, A.P., V.A.Matyash, V.A. *Leukemia and thyroid cancer in emergency workers of the Chernobyl accident. Estimation of radiation risks (1986-1995)*. Radiat. Environ. Biophys. 1997, v.36, pp.9-25.
13. Malko, M.V.. *Thyroid cancer in Belarus*. In the book: The radiological catastrophe in Chernobyl: Report of the international study. Tokyo, Japan. 1998, pp.218-222 (in Japanese).

14. Malko, M.V.. *Risk Assessment of Radiation-Induced Thyroid Cancers in Belarus*. Environmental Management and Health. Vol.11, N5, 2000, pp.455-467.
15. Demidchik, E.P., Okeanov, A.F., Rebeko, V.Y., Demidchik, Yu.E. *Current trend in prophylaxies, early diagnosis, and curative treatment of thyroid cancer in Belarus*. In the book: The Chernobyl accident. Thyroid abnormalities in children, congenital abnormalities and other radiation related information. The first ten years. Editor: Nobuo Takeichi. Associated Editor: Yukio Satow. English Editor: Robert H.Masterson. First edition. 1996. Published by Hiroshima-Nagasaki Peace Foundation, Japan, pp.89-93.
16. Demidchik E.P. *Epidemiology and surgery of thyroid carcinom*. Report at the annual meeting of the German Societies of the Radiation Studies. 16-18 March 1998. Munich, FRG.
17. Demidchik, E.P., Tsyb, A.F., Lushnikov, T.F. *Thyroid Cancer by Children. Consequences of the Accident at the Chernobyl NPP*. Moskow. "Medizina", 1996 (in Russian).
18. Demidchik, E.P., Demidchik, Yu.E., Gedrevich, Z.E. et al. *Thyroid Cancer: 15 Yars after Chernobyl*. Proceedings of the International Scientific and Practical Conference "Medical Consequences of the Chernobyl Catastrophe. 15 Yars After". Minsk. 2001, pp.20-21 (in Russian).
19. Demidchik, E.P. *Private communication*.
20. Belarusian Cancer Registry. *Malignant neoplasms in Belarus: 1983 – 1992*. Minsk, 1993.
21. Belarusian Cancer Registry. *Malignant neoplasms in Belarus: 1984 – 1993*. Minsk, 1994.
22. Belarusian Cancer Registry. *Malignant neoplasms in Belarus: 1985 – 1994*. Minsk, 1995.
23. Belarusian Cancer Registry. *Malignant neoplasms in Belarus: 1986 – 1995*. Minsk, 1996.
24. Belarusian Cancer Registry. *Malignant neoplasms in Belarus: 1987 – 1996*. Minsk, 1997.
25. Belarusian Cancer Registry. *Malignant neoplasms in Belarus: 1988 – 1997*. Minsk, 1998.
26. Belarusian Cancer Registry. *Malignant neoplasms in Belarus: 1989 – 1998*. Minsk, 1999.
27. Belarusian Cancer Registry. *Malignant neoplasms in Belarus: 1990 – 1999*. Minsk, 2000.
28. Belarusian Cancer Registry. *Malignant neoplasms in Belarus: 1991 – 2000*. Minsk, 2001.
29. Ministry of Statistics and Analysis. *Population of the Republic of Belarus. Statistical book*. Minsk, 1995.
30. Ministry of Statistics and Analysis. *Population of the Republic of Belarus. Statistical book*. Minsk, 1996.
31. Ministry of Statistics and Analysis. *Population of the Republic of Belarus. Statistical book*. Minsk, 1997.
32. Ministry of Statistics and Analysis. *Population of the Republic of Belarus. Statistical book*. Minsk, 1998.
33. Ministry of Statistics and Analysis. *Population of the Republic of Belarus. Statistical book*. Minsk, 1999.
34. Ministry of Statistics and Analysis. *Population of the Republic of Belarus. Statistical book*. Minsk, 2000.
35. Matweenko, I.I., Germenchuk, M.G., Shagalova, E.D., Zhukova, O.M. *Migration and Forecast of the Radioactive Contamination of the Soil, Water and Air on the Territory of Belarus after the accident at the Chernobyl NPP*. In: Proceedings of the International Conference "One Decade after Chernobyl: Summing up the Consequences of the Accident"; 1996 April 8-12; Vienna, Austria. Vienna: IAEA; 1997. Poster Presentation. V2.pp 64–70.
36. Gofman, J.W. *Radiation and human health. A comprehensive investigation of the evidence relating low-level radiation to cancer and other diseases*. 1981. Sierra Club Books. San Francisco, pp.103-109.
37. Mironov V, Kudrjashov V, Yiou F, Raisbeck GM. *Use of ¹²⁹ and ¹³⁷Cs in soils for the estimation of ¹³¹I deposition in Belarus as a result of the Chernobyl accident*. J.Environ. Radioact. In press 2001.
38. Robbins, J., Adams, W. *Radiation effects in the Marshall Islands*. In the book: Radiation and the thyroid. Edited by S. Nagataki. Amsterdam. Excerpta Medica. 1989, pp.11-24.
39. Kerber, R.A., Till, J., Simon S.et al. *A cohort study of thyroid disease in relation to fallout from nuclear weapon testing*. J.Am. Med. Assoc. 1993, v.270, pp.2076-2082.
40. Ron, E., Preston, D.L., Mabuchi, K., Thompson, D.E., Soda, M. *Cancer incidence in atomic bomb survivors. Part IV: Comparison of cancer incidence and mortality*. Radiation Res. 1994, v.137, pp.98-112.
41. National Council on Radiation Protection and Measurements. *Influence of dose and its distribution in time on dose-response relationships for low-LET radiation*. NCRP Report No. 64. Bethesda, Maryland. 1980.
42. United Nations Scientific Committee on the Effects of Atomic Radiation. *Sources and effects of Ionizing Radiation*. UNSCEAR 1988 Report to the General Assembly, with annexes. United Nations. New York.1988, p.492.
43. International Commission on Radiological Protection. Publication 60. Pergamon Press. Oxford. New York.

Frankfurt. Seoul. Sydney. Tokyo. 1991, pp.108-111.

44. Holm, L.E., Wiklund, K.E., Lundell, G.E. et al. *Thyroid cancers after diagnostic doses of iodine-131*. J.Natl.Cancer Inst., 1988. V.80, pp.1132-1137.
45. Ivanov, V.K., Rastopchin, E.M., Gorsky, A.I. and Ryvkin, V.B. *Cancer incidence among liquidators of the Chernobyl accident: solid tumors, 1986-1995*. Health Physics. 1998, v.74, N3, pp.309-315.
46. Ivanov, V.K., Gorsky, Maksioutov, M.A., Tsyb, A.F. and Souchkevitch, G.N. *Mortality among the Chernobyl emergency workers: estimation of radiation risks (preliminary analysis)*. Health Physics. 2001, v.81, N5, pp.514-521.
47. Malko, M.V. *Radiation-induced malignant tumors in Belarus as a result of the Chernobyl accident*. Int. J. Rad. Medicine. 2001, v.3, N1-2, p.81.
48. Jakob, P., Goulko, G., Heidenreich, W.F. *Thyroid cancer risk to children calculated*. Nature. 1998, v.392, pp.31-32.
49. Gilbert, E. *Late somatic effects*, pp. II-89 – II-138, in: Health effects model for nuclear power plant accident consequence analysis. Part I. Introduction, integration and summary. Part II. Scientific basis for health effects models. NUREG/CR-4212 (1985).

Analysis of Chromosome Aberrations in Human Lymphocytes after Accidental Exposure to Ionizing Radiation

Galina SNIGIRYOVA and Vladimir SHEVCHENKO*

*Russian Scientific Center of Roentgeno-Radiology, MOH RF,
Profsoyuznaya st. 86, GSP-7, 117997 Moscow, Russia: snigiryova@mrids.rssi.ru*

**N.I. Vavilov Institute of General Genetics, RAS,
Gubkin st. 3, 117809 Moscow, Russia: Shevchenko@vigg.ru*

Abstract

Aim: Analysis of the results of cytogenetic examination and reconstruction of irradiation doses by the frequency of chromosome aberrations in the liquidators of the consequences of the Chernobyl NPP accident.

Materials and methods: Over 1500 people who worked in the zone of the accident predominantly in 1986 and in 1987 have been examined since 1986. All of them were examined by means of the classical cytogenetic method which makes it possible to assess the level of unstable chromosome aberrations. 64 patients (including 12 professional workers of the Kurchatov Institute) were examined by the FISH method which permits the estimation of the level of symmetrical translocations.

Results: The cytogenetic examination performed in 1986 revealed a high level of cells with dicentrics (exceeding 16-fold the control level) in the group of liquidators. In succeeding years this level significantly decreased. However even in 15 years after the works in the zone of the accident were completed the frequency of cells with dicentrics in the group of liquidators significantly exceeds the control level. Using the frequency of cells with dicentrics and the calibration dose-response curve, the dose of irradiation was determined for the group of liquidators examined in 1986. The average dose of irradiation made up 0.14 Gy. The frequency of translocations was used to estimate the exposure dose for the group of 52 liquidators. The average dose for the whole group was estimated to be 0.16 Gy. For 18 patients in whom the frequency of translocations significantly differed from the control level the individual doses of exposure were determined. The scatter in the doses was from 0.22 to 1.0 Gy.

In 1996, 22 workers of the Kurchatov Institute were examined. In most of them (13 patients) the frequency of dicentrics in peripheral blood lymphocytes was significantly higher than the control values. In five patients, cells with multiple chromosome aberrations were discovered. Three examined workers were exposed to super-high doses. The frequency of dicentrics in peripheral blood lymphocytes of these patients was 100 and even 1000 times higher than the control level. The doses of irradiation estimated for five workers of the Kurchatov Institute by the frequency of translocations using the calibration curve were in the range between 0.21 and 2.51 Gy. These doses were calculated without correction coefficients, i.e. without taking into account the fact that those workers were for several years exposed to multiple irradiations at different dose rates. Consideration of these conditions will lead to an increase of the estimated absorbed doses.

Conclusion: The cytogenetic methods are sufficiently sensitive for assessing the condition of the cell hereditary structures. Analysis of unstable chromosome aberrations is a decisive method in monitoring of large groups of people exposed to radiation as a result of nuclear accidents. The data of cytogenetic examination can be one of the criteria in the formation of groups with an increased risk of development of different diseases. One of the most promising cytogenetic methods of biological dosimetry is the analysis of stable translocations by the FISH method. The lower limit of dose estimation by the frequency of translocations is 20-25 cGy.

1. Introduction

It is already over several decades that the analysis of chromosome aberrations in peripheral blood lymphocytes has been successfully used to examine people exposed to radiation during various accidents [1-9]. The results of cytogenetic analysis serve as a basis for estimating absorbed radiation doses and for predicting possible negative effects of irradiation.

The traditional procedure in biodosimetric studies is the analysis of the frequency of chromosome aberrations, namely, dicentrics or symmetrical translocations. The radiobiological basis for applying cytogenetic indices in dosimetric studies is the existence of a relationship between the dose and the yield of chromosome aberrations as well as the coincidence of dose-effect curves upon irradiation of blood cells *in vitro* and *in vivo*. It is customary to assume (and it was corroborated in some investigations) [10,11] that the frequencies of dicentrics and translocations immediately after irradiation are practically the same.

Cells with dicentrics are good indicators of irradiation within short periods after radiation exposure. With post exposure time such cells are eliminated from peripheral blood because their passage through mitosis is impeded [12]. In connection with this, the analysis of the frequency of dicentrics is of low efficiency for retrospective estimation of radiation doses. After a long time following the radiation exposure as well as under conditions of long-term chronic or prolonged irradiation the accumulated dose is estimated using the analysis of stable chromosome aberrations – symmetrical translocations. In the opinion of some authors [5,6,13-15] the frequency of cells with translocations remains constant for a long time after irradiation or, as other researchers [16,17] suppose, it may decrease, but with a considerably slower tempo as compared to cells with dicentrics. The latter fact imposes some limits on the assessment of radiation doses by the frequency of translocations but the importance of using cytogenetic methods in biodosimetric studies does not become less. In emergency situations, when reliable methods of physical dosimetry are often absent, the analysis of chromosome aberrations permits the degree of radiation damage of the organism to be determined taking into account its specific individual features and, in the first turn, its individual radiosensitivity. Information on “biological dose” is of great prognostic value for assessing the remote effects of irradiation and for choosing adequate methods of therapy and prophylaxis.

In the case of large-scale cytogenetic monitoring in groups of people exposed to radiation as a result of radiation accidents the analysis of unstable chromosome aberrations assumes particular importance. It allows sufficiently large contingents of exposed people to be examined without special financial expenditures and without employing sophisticated techniques. The results of such monitoring make it possible to obtain information on the effects of the radiation factors on the organism, on the degree of genome damage, and finally they can be used as criteria in the formation of groups of people with a high risk of occurrence of different diseases, including oncological ones [18,19].

2. Subjects, materials and methods

2.1. Case reports of examined patients

The Chernobyl nuclear power plant accident is the most dramatic ecological disaster of the 20th century. One of the largest categories of the population that has suffered most as a result of this catastrophe are the clean-up workers (liquidators). Beginning in 1986, the Russian Research Center of Roentgeno-Radiology and N.I. Vavilov Institute of General Genetics have been carrying out joint cytogenetic examinations of the liquidators [20,21]. Over 1500 persons have been examined by the present time. All examined liquidators participated in the restoration works within the 30 km zone in 1986 and 1987. Some of the liquidators came to work in Chernobyl in succeeding years, too, up to 1995. The total term of working in the zone of the accident was from 2 weeks to 13 months. The works made by the liquidators were highly diversified. Among the examined patients there were specialists in the field of dosimetry and decontamination, scientific workers, physicians, drivers, erectors, “sarcophagus” builders, helicopter pilots and unskilled labourers. Most of the liquidators were exposed to doses up to 1 Gy.

Official data on irradiation doses are available for approximately 60% of the examined patients. It should be noted that during the work in the zone of the accident the liquidators were exposed to additional factors of the non-radiation nature, including acute and chronic psychoemotional overloads, changes in the habitual stereotype of life and in the dietary regimen determined by the forced staying on the contaminated territory [22].

All people who participated in the restoration works were examined by the classical cytogenetic method permitting us to estimate the level of unstable chromosome [23]. Part of the patients (52 persons) was cytogenetically analyzed by the FISH method which allowed estimating the level of stable chromosome aberrations [24].

The obtained cytogenetic data were compared with the results of examination of the control group composed of quite healthy people of analogous age having no occupational contacts with ionizing radiation sources (118 persons for classical analysis and 15 persons for FISH analysis).

2.2. *Lymphocyte culture and slide preparation*

The venous blood was collected in sterile test-tubes with lithium heparinate. Lymphocyte enriched plasma was obtained by centrifugation of whole blood for 40-50 min at 1000 rpm. After that, 0.5 ml of the blood plasma was mixed with 4.5 ml of RPMI-164 medium containing 15% fetal calf serum, 2.5% of phytohaemagglutinin, 2 mM glutamine, antibiotics and 10 mM BrdU. The cultures were incubated at 37°C for 48 hours. Chromosome preparations were obtained according to standard procedures [23].

Slides used for analysis of unstable chromosome aberrations were kept for 5 days at room temperature and then subjected to special fluorescence plus Giemsa (FPG-) staining. For analysis of stable chromosome aberrations the slides were kept in a nitrogen atmosphere at -20°C until the moment of further treatment. A cocktail of probes was used for investigation with the FISH method: biotin-labelled DNA probes for chromosome 1, 4 and 12 in combination with a digoxigenin-labelled pancentromeric probe. DNA probes for our work were kindly provided by the Laboratory of Cytogenetics of the Institute of Radiobiology (GSF, Munich). Hybridization in situ with DNA probes was carried out by the method of [24]. Probes for chromosomes were identified using fluorescein isothiocyanate (FITC) – labelled streptavidin and pancentromeric probes and 7-amino-4-methylcoumarin-3-acetic acid (AMCA) – labelled antibodies. Propidium iodide (PI) was used as a counterstain in antifade solution. The analysis was performed using a set of filters permitting a simultaneous observation of the fluorescence of FITC and PI as well as AMCA and PI.

Genomic frequencies (F_G) for symmetrical translocations were calculated from the frequencies of painted translocations (F_P) for target chromosomes by inversion of the equation $F_P = 2.05 \times f_p (1 - f_p) \times F_G$, where $f_p = 0.192$ is the fraction of the DNA contained in the painted chromosomes.

2.3. *Dose-response curves*

The doses of irradiation received by the liquidators in the course of the restoration works in the zone of the accident were determined, depending on the situation, either by the frequency of dicentrics or by the frequency of translocations using the calibration dose-response curves obtained by us earlier [25].

An extensive experimental material was analyzed to construct calibration dose-response curves – blood samples from 5 donors were examined in the dose range from 0 to 4 Gy (dose rate – 0.1 Gy/min). 55007 cells were analyzed by the classical method (dicentrics) and 15561 cells were analyzed by the FISH method (translocations). The calibration curve for the frequency of stable chromosome aberrations was based on the frequency of translocations involving chromosomes 1, 4 and 12. Complete and incomplete translocations were taken into account.

The data of cytogenetic analysis of dicentrics and translocations served as a basis for regression equations characterized by a high degree of significance. α and β coefficients for dicentrics made up 0.015

$\pm 0.04 \text{ Gy}^{-1}$ and $0.063 \pm 0.003 \text{ Gy}^{-2}$, respectively, and for translocations – $0.007 \pm 0.003 \text{ Gy}^{-1}$ and $0.017 \pm 0.002 \text{ Gy}^{-2}$, respectively.

3. Results

3.1. Analysis of chromosome aberrations in the group of liquidators

3.1.1. Dicentrics

Table 1 presents the results of analysis of the frequency of unstable chromosome aberrations (dicentrics) in the group of liquidators for the period from 1986 to 2001. In the first year of examination the average frequency of cells with dicentrics in the group of liquidators was 0.33 per 100 cells and exceeded 16-fold the analogous index in the control group (control – 0.02 per 100 cells). In a year the frequency of cells with dicentrics in the examined group of liquidators decreased more than 2-fold and constituted 0.14 per 100 cells. Further on, the frequency of cells with dicentrics continued decreasing but not so sharply as in the first year after the accident. Through the whole period of observation, this index remained to be significantly higher as compared to the control level. The frequency of cells with dicentrics varied from 0.06 to 0.18 per 100 cells throughout the whole period of examination. Even 15 years after the Chernobyl accident the level of this index exceeds the control. Thus, despite a very long period after the end of the clean-up works in the zone of the accident, we can observe a radiation-induced effect which is most likely determined by the radiation damage of hematopoietic tissue stem cells leading to a gradual introduction in peripheral blood of lymphocytes carrying chromosome aberrations.

For the group of liquidators cytogenetically examined in 1986 the dose of irradiation was estimated using the calibration dose-response curve for dicentrics. The average dose for the group made up 0.14 Gy.

3.1.2. Translocations

Table 2 presents the results of cytogenetic examination of 52 liquidators. They were examined between November 1992 and July 1995. The average frequency of translocations (1.2 ± 0.16 per 100 cells) in the group of liquidators significantly (2.5-fold) exceeds the control level (0.47 ± 0.09 per 100 cells). In the subgroup of liquidators who worked several times in Chernobyl in the period from 1986 to 1995 the frequency of translocations exceeds 2-fold that in the subgroup of liquidators who worked only in 1986. The differences between these subgroups of examined liquidators are statistically significant. There were no differences in the frequency of translocations between the subgroup of liquidators (35 patients) for whom we had official data on the irradiation dose (1.2 ± 0.19 per 100 cells) and the subgroup

Table 1. Cytogenetic results (classical method), pooled data for groups of liquidators.

Year of examination	Number of subjects	Number of cells scored	dic per 100 cells \pm SEM
1986	443	41927	0.33 ± 0.03
1987	280	44268	0.14 ± 0.02
1990	23	4268	0.10 ± 0.05
1991	110	20077	0.09 ± 0.02
1992	136	32000	0.14 ± 0.02
1993	75	18581	0.09 ± 0.02
1994	69	20879	0.16 ± 0.03
1995	110	30012	0.06 ± 0.01
1996	53	17960	0.07 ± 0.02
1997	126	63462	0.09 ± 0.01
1998	77	39426	0.09 ± 0.01
1999	41	22524	0.12 ± 0.02
2000-2001	28	14000	0.09 ± 0.02
Controls	118	48124	0.02 ± 0.01

dic, dicentric chromosomes; SEM, standard error of the mean.

Table 2. Cytogenetic results (FISH method), pooled data for the total group and for subgroups of liquidators.

Group	Number of subjects	Number of cells scored	Translocations $F_G \pm SEM$ per 100 cells	Estimated dose (95% c.l.), Gy
Total	52	44283	1.20 ± 0.16	0.16 (0.11-0.21)
Working only in 1986	35	28767	0.86 ± 0.13	0.06 (0 – 0.14)
Working 1986-1995 (several times)	17	15516	1.81 ± 0.35	0.29 (0.25-0.34)
With documented dose	35	29614	1.20 ± 0.19	0.16 (0.11-0.21)
Without documented dose	17	14669	1.20 ± 0.31	0.16 (0.11-0.21)
Controls	15	21953	0.47 ± 0.09	

F_G , genomic translocation frequency; SEM, standard error of the mean; c.l., confidence limits.

of liquidators (17 patients) for whom such data were missing (1.2 ± 0.31 per 100 cells).

Using the frequency of translocations and the dose-response calibration curve, we calculated the irradiation doses for the group of examined liquidators. The average value of the calculated dose for the whole examined group constituted 0.16 Gy. For the subgroup of liquidators who worked only in 1986 the value of the “biological dose” made up 0.06 Gy, and for the liquidators who worked in Chernobyl several times for the period from 1986 to 1995 the value of the “biological dose” was 5 times higher – 0.29 Gy. It is important to note that the obtained dose values are equivalent to the dose of a single acute exposure.

In 18 out of 52 examined liquidators the frequency of translocations significantly differed from the control level. The individual data of cytogenetic analysis for these liquidators are presented in Table 3. It also demonstrates the individual doses of irradiation calculated using the calibration dose-response curve. For three examined liquidators the dose values were rather high. The dose calculated for patient L31 was 1 Gy. The dose recorded for this patient in the documents was 1.36 Sv. Patient L53 did not have official data on the irradiation dose although he worked in Chernobyl several times during 1986-1995. The “biological” dose of irradiation for this patient made up 0.68 Gy. The dose of 0.5 Gy was also calculated for liquidator L51 who worked at the reactor in 1986. Official data on the dose absorbed by him were also

Table 3. Cytogenetic results and biodosimetry estimates for 18 liquidators.

Case no.	Blood sampling	Number of cells scored	St per 100 cells $F_G \pm SEM$	Estimated dose (95% c.l.), Gy	Documented dose, Sv	Working time (months)		
						1986	1987	>1987
L17	March, 1994	1297	1.9 ± 0.7	0.31 (0.16-0.46)	0.14	1.3	-	-
L19	May, 1995	570	1.7 ± 1.0	0.26 (0.05-0.47)	0.02	2.0	-	-
L20	March, 1994	1314	2.4 ± 0.8	0.43 (0.29-0.57)	0.17	1.3	-	-
L23	May, 1995	857	2.2 ± 0.9	0.36 (0.17-0.54)	0.29	1.5	2.5	-
L25	April, 1994	1161	2.4 ± 0.8	0.40 (0.26-0.54)	0.11	-	2.5	-
L27	June, 1995	1688	2.0 ± 0.6	0.34 (0.20-0.48)	0.80	4.5	2.0	0.5
L28	June, 1995	395	2.4 ± 1.4	0.39 (0.14-0.64)	0.25	4.8	1.0	3.0
L30	June, 1996	797	1.6 ± 0.8	0.25 (0.04-0.46)	0.50	1.0	1.0	3.0
L31	April, 1994	473	7.3 ± 2.2	1.00 (0.40-1.40)	1.36	1.0	1.2	3.0
L33	June, 1995	1157	1.6 ± 0.7	0.26 (0.11-0.41)	0.60	1.9	-	6.5
L34	July, 1995	1097	1.4 ± 0.6	0.22 (0.07-0.37)	0.26	2.0	-	6.0
L41	March, 1994	756	1.2 ± 0.7	0.17 (0.00-0.40)	-	1.0	-	-
L45	April, 1993	410	2.3 ± 1.3	0.38 (0.13-0.64)	-	2.0	-	-
L46	May, 1995	1459	1.5 ± 0.6	0.23 (0.08-0.38)	-	0.3	-	-
L47	February, 1993	859	1.8 ± 0.8	0.30 (0.10-0.50)	-	1.4	-	-
L51	January, 1994	583	3.2 ± 1.3	0.50 (0.31-0.69)	-	1.0	-	-
L52	June, 1995	1209	1.8 ± 0.7	0.29 (0.14-0.44)	-	1.5	1.5	-
L53	February, 1994	1016	4.6 ± 1.2	0.68 (0.55-0.81)	-	3.0	3.0	2.5

St; symmetrical translocation, F_G ; genomic translocation frequency, SEM; standard error of the mean, c.l.; confidence limits.

missing.

For most of the examined liquidators (15 patients) the individual doses were estimated in the range from 0.22 to 0.43 Gy. For those liquidators whose irradiation dose was recorded in official documents the “biological doses” were in agreement to the data of physical dosimetry (L23, L28, L34). However, it should be kept in mind that in certain cases the obtained doses might be slightly underestimated (L27, L30, L31, L33) because the doses were calculated on the basis of the calibration curve generated for irradiation at a dose rate of 0.1 Gy/min under conditions of an acute single exposure. In fact, many of the clean-up workers could be exposed to prolonged irradiation at a lower dose rate. An illustrative example is liquidator L27 who himself is a specialist in the field of dosimetry and used an individual dosimeter for the whole period of working in Chernobyl. By his measurements, his irradiation dose is 0.83 Sv. The dose calculated by the frequency of translocations made up 0.34 Gy.

The results obtained clearly demonstrate that the analysis of translocations by means of the FISH method is a sufficiently sensitive technique for retrospective assessment of the radiation effect in the liquidators participating in the clean-up works after the Chernobyl accident. Unfortunately, it is difficult to find a scientific meaning in comparing the data of physical and biological dosimetry since it is known that in many cases the data of physical dosimetry (from the point of view of official dosimetry) did not correspond to the real doses that might be received by the liquidators during their work in the zone of the accident. In connection with this, the results obtained by means of biological dosimetry acquire particular importance and, namely, they help in assessing possible unfavorable impacts of radiation on the human organism.

3.2. Cytogenetic examination of the workers of I.V.Kurchatov Institute of Atomic Power participating in the liquidation of the consequences of the Chernobyl NPP accident

In 1996 a group of 22 workers of the Kurchatov Institute was subjected to cytogenetic examination. In the first days after the accident they began research work in the zone of the accident. The main tasks of this work were to establish the causes of the accident, to examine the condition of the reactor, nuclear fuel, structural constructions of the 4th block and to study the radioactive conditions in the zone of the Chernobyl NPP and on the controlled territory. All of the examined patients were exposed to low-dose chronic irradiation in the course of their professional activity due to contacts with different sources of radiation. Most of them started working under unhealthy occupational conditions in the early 60ies. The official annual dose up to 1986 did not exceed 0.05 Gy. 18 persons from the examined group worked in Chernobyl in 1986 and in 1987. Four out of the examined patients carried out research works at the nuclear plant till the middle 90ies. For 19 persons the official doses of irradiation ranged from 0.08 to 0.52

Table 4. Personal data for the examined group from the Kurchatov Institute.

Case No.	Number of cells scored	Working time at Chernobyl	Documented dose (cSv)*
K ₃	65	1986; 1981-1991	8.57
K ₄	57	May, 1986	24.85
K ₆	56	November, 1986	27.27
K ₈	49	June, 1986	24.45
K ₉	44	September, 1986	12.60
K ₁₂	48	October, 1986	10.71
K ₁₃	64	July, 1986	1.55
K ₁₄	51	October, 1986	4.63
K ₁₅	56	October, 1986	41.69
K ₂₀	49	1986-1996	1710**
K ₂₁	63	1986-1994	360**
K ₂₈	44	1986-1996	1160**

* Doses accumulated during working in Chernobyl.

** This dose was obtained from the paper of A.V. Sevan'kaev et.al., 1995.

Sv. The values of these doses were obtained from the dosimetric register of the Kurchatov Institute. Three persons (K20, K21, K28) from the examined group were exposed to super-high doses. The individual characteristics of the examined group are presented in Table 4. The publication about these persons was in the journal Radiation Protection Dosimetry [26].

Table 5 presents the individual data of cytogenetic examination by means of the classical method (analysis of the frequency of unstable chromosome aberrations). The values of the frequencies of dicentrics and centric rings (markers of radiation exposure) in 13 examined workers of the Kurchatov Institute significantly exceed the control level. In 5 patients (K4, K5, K20, K21, K28) the blood contained cells with multiple chromosome aberrations (with dicentric chromosomes). Taking into consideration that the examined persons could be irradiated from different radiation sources, it can be suggested that the appearance of such cells in their blood is the result of the action on the organism of high-LET ionizing radiation

In three patients from the examined group who were exposed to super-high doses (K20, K21, K28) the frequency of dicentrics and centric rings was 100 and even 1000 times higher than the control level. These workers were subjected to cytogenetic examination several times in the period from 1996 to 2001. Here we present only the results of cytogenetic analysis obtained in 1996. It should be noted that by the moment of examination there were no health complaints from these patients.

Table 6 presents the individual results of cytogenetic analysis performed with the use of the FISH

Table 5. Cytogenetic results (classical method) for the workers from the Kurchatov Institute.

Case No.	Number of cells scored	dic+ Rc per 100 cells \pm SEM	Cdr per 100 cells \pm SEM
K ₂	871	0.69 \pm 0.28 *	0.69 \pm 0.28 *
K ₃	1300	0.08	0.08
K ₄	1200	0.42 \pm 0.28 *	0.25 \pm 0.14 *
K ₅	600	0.33 \pm 0.24 *	0.33 \pm 0.24 *
K ₆	1004	0.40 \pm 0.24 *	0.30 \pm 0.17 *
K ₇	500	0	0
K ₈	1300	0.08	0.08
K ₉	550	0	0
K ₁₀	1300	0.08	0.08
K ₁₂	800	0.38 \pm 0.22 *	0.38 \pm 0.22 *
K ₁₃	800	0	0
K ₁₄	1000	0.20 \pm 0.14 *	0.20 \pm 0.14 *
K ₁₅	1000	0.30 \pm 0.17 *	0.30 \pm 0.17 *
K ₁₆	1000	0	0
K ₁₇	1000	0.20 \pm 0.14 *	0.20 \pm 0.14 *
K ₁₈	1000	0.30 \pm 0.17 *	0.30 \pm 0.17 *
K ₂₂	1133	0	0
K ₂₅	1000	0.50 \pm 0.22 *	0.50 \pm 0.22 *
K ₂₇	1000	0.10	0.10
K ₂₀	279	20.50 \pm 2.70 *	18.00 \pm 2.50 *
K ₂₁	830	2.80 \pm 0.60 *	2.80 \pm 0.60 *
K ₂₈	500	20.40 \pm 2.00 *	19.20 \pm 1.90 *
Control	48124	0.02 \pm 0.01 *	0.02 \pm 0.01 *

dic; dicentric chromosomes, Rc; centric rings, Cdr; cells containing dic+Rc, SEM; standard error of the mean (only for cases with more than one aberration),

* significantly different from control ($p < 0.05$).

method among 12 workers of the Kurchatov Institute. The frequency of symmetrical translocations in five cases significantly exceeds the control level (0.47 per 100 cells). The table also gives the values of individual doses calculated on the basis of cytogenetic indices. The dose values for patients K4 and K14 turned out to be higher than those presented in Table 4. One of the causes seems to be the fact that before starting working in the zone of the accident at the Chernobyl NPP these persons worked for a long time under unhealthy occupational conditions. For instance, patient K4 worked with the sources of ionizing radiation since 1962. By 1986 his total accumulated dose constituted 29 cSv. Patient K14 worked with fluorine-containing substances for more than 10 years.

For three workers of the Kurchatov Institute (K20, K21, K28) exposed to super-high doses of ionizing radiation the biological doses calculated by the frequency of translocations significantly differ from those presented in Table 4. The causes of such discrepancy can be summarized as follows. First, the doses were determined using the calibration curve obtained under conditions of acute single irradiation. In reality, these specialists worked in the zone of the accident for several months almost every year over 10 years. In addition, they were repeatedly exposed to high-dose radiation. The total irradiation dose for these patients was accumulated under conditions of fractionated exposure. Taking into account the character of irradiation, it is more desirable to use the linear dose-response relationship for dose calculations [8]. In this case the irradiation dose can be determined by the following formula:

$$D = (Y - Y_0) / \alpha,$$

where Y is the frequency of measured translocations, Y_0 – the frequency of spontaneous translocations, α – the linear coefficient.

The doses calculated according to this formula for the examined patients K20, K21 and K28 made up 10.3, 3.1 and 19.1 Gy, respectively. The values of these doses are already quite comparable with the doses presented in Table 4. It should be noted, however, that such estimates are rather rough. A more precise assessment of doses needs a detailed analysis of the history of irradiation of these persons during their work in the zone of the accident at the Chernobyl nuclear power plant.

Another important point to be mentioned is that the cytogenetic examination was carried out 10 years after the beginning of exposure. During that time two opposite processes took place in the blood of the irradiated patients: gradual elimination of cells with unstable chromosome aberrations (dicentrics, centric rings) in which stable translocations were also detected, and a simultaneous accumulation in peripheral blood of cells with chromosome aberrations due to additional irradiation. There is no doubt that this fact

Table 6. Cytogenetic results (FISH method) for the workers from the Kurchatov Institute.

Case No.	Number of cells scored	$F_G \pm SEM$ (ST per 100 cells)	Estimated dose (95% c.l.), Gy
K3	1135	0.57 ± 0.38	NS
K4	1134	$3.32 \pm 0.94^*$	0.54 (0.40-0.68)
K6	1043	0.91 ± 0.53	NS
K8	1062	0.88 ± 0.50	NS
K9	843	1.13 ± 0.66	NS
K12	1271	0.50 ± 0.35	NS
K13	1000	0.33	NS
K14	1350	$1.38 \pm 0.57^*$	0.21 (0.06-0.36)
K15	1571	1.00 ± 0.44	NS
K20	2169	$22.20 \pm 1.00^*$	1.78 (1.69-1.87)
K21	2031	$6.96 \pm 0.60^*$	0.88 (0.78-0.98)
K28	950	$40.90 \pm 2.10^*$	2.51 (2.38-2.64)
Control	21953	0.47 ± 0.09	

F_G ; genomic translocation frequency, ST; symmetrical translocations, SEM; standard error of the mean (only for cases with more than one aberration), c.l.; confidence limits, * significantly different from control ($p < 0.05$).

considerably impedes obtaining reliable information on irradiation doses. However, a rough estimation of absorbed radiation doses, and, what is more important, with regard to the individual peculiarities of an irradiated organism, can be made.

The data obtained by the frequency of translocations (Table 6) permitted us to analyze the dependence between the level of individual values and the documented dose for the examined persons. These data are presented in Fig. 1. The results of examination of patients K20, K21 and K28 are omitted here. The dotted line indicates the linear-quadratic curve and the unbroken line indicates its linear component. It should be noted that for all patients (except one) a good correlation between the frequency of translocations and the officially registered irradiation dose is observed. The values of translocation frequencies for two patients lie higher than the linear-quadratic calibration curve. It can thus be suggested that those workers could be exposed to higher doses than those recorded in the documents. In three of the examined workers with documented dose larger than 0.2 Sv, the value of the translocation frequency lies considerably below our linear-quadratic calibration curve but in the range of its linear part. Assuming that the official dose in this worker is close to the real one, this fact, as has been mentioned above, shows an evidence that irradiation with rather low dose rates or fractionated exposures produce cytogenetic damages less effective than single acute irradiation.

It is important to mention that the dependence of the translocation frequency on the exposure dose is also observed for persons in whom the dose values were not determined because of insignificant differences between the cytogenetic indices and the control. With a low level of translocations in peripheral blood lymphocytes an analysis of extensive material (a large number of cells) is required in order to obtain reliable data. Unfortunately, it is often impossible in connection with large expenses. The lower limit of dose estimation by the frequency of translocations, as shown by our studies, is 20-25 cGy with 1000 – 1500 cells analyzed. To estimate a dose below this threshold it is necessary to significantly increase the number of cells to be analyzed. The data presented in Table 6 and in Fig. 1 support this conclusion.

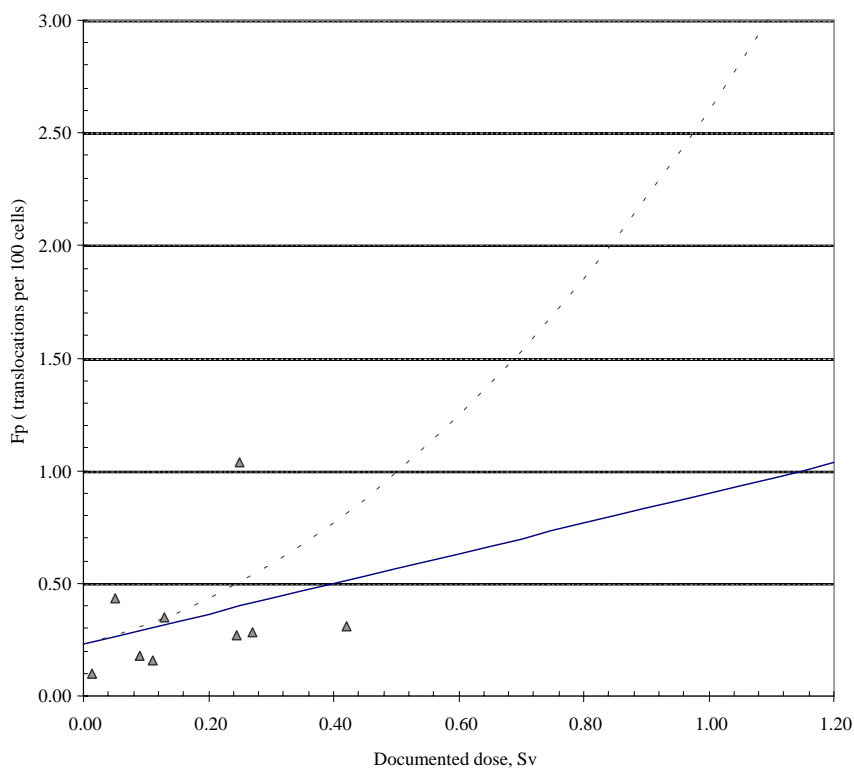

Figure 1. Dose-response relationship of translocation frequencies (Fp) with documented doses (explanatory notes are in the text).

4. Conclusion

The results of cytogenetic examination of the “liquidators” permit the following conclusions to be made.

- The cytogenetic methods (classical and FISH methods) are sufficiently sensitive for assessing the condition of the cell hereditary structures.
- It was found that the level of cells with dicentrics in the examined liquidators in the first year after the work in the zone of the accident significantly exceeded the control level. With time, years after the radiation exposure, this level gradually decreased but it did not reach the control level even within 15 years after the accident. The average frequency of cells with dicentrics in the recently examined group of liquidators made up 0.09 % exceeding 5-fold the control values.
- Using the frequency of cells with dicentrics, an average dose for the group of liquidators examined in 1986 was determined. The calculated dose constituted 0.14 Gy. Retrospective estimation of irradiation doses (both individual and for the groups) on the basis of analysis of cells with dicentrics does not seem possible. It is first of all due to the elimination of such cells from the peripheral blood of the examined patients.
- However, in the course of large-scale monitoring in groups of people who suffered after accidents or emergency situations, analysis of unstable chromosome aberrations by means of the classical cytogenetic method is decisive as it does not require large funds and technical resources. During retrospective examination of the liquidators the analysis of cells with unstable chromosome aberrations (dicentrics and centric rings) can be used predominantly for bioindication of the mutagenic action of ionizing radiation. The results of such analysis can be considered as a criterion in the formation of groups at risk with regard to the development of different diseases and primarily oncological ones
- The FISH method is the most promising cytogenetic method in biological dosimetry. It allows one to analyze the frequency of cells with stable chromosome aberrations – symmetrical translocations. The data presented here suggest that this method can be used rather extensively for estimating radiation doses. In most cases the doses calculated by the frequency of translocations are in good agreement with the data of physical dosimetry. Some underestimation of biological doses is primarily due to the fact that the calibration dose response curves for the frequency of translocations were obtained under definite conditions – single acute irradiation. Under real conditions the liquidators were, as a rule, exposed to chronic or prolonged radiation. In connection with this, in determining irradiation doses it is necessary to introduce the correction coefficient which makes it possible to take into account the real conditions of exposure.
- The results of cytogenetic examination by means of the FISH method presented in this work suggest the existence of irradiation levels below which the dose estimation by the frequency of translocations seems to be unlikely. The causes of such limitation can be quite diverse: interindividual variability of the translocation frequency, ability to repair radiation damage, the volume of analyzed material (the number of analyzed cells). According to our data, the real lower threshold of dose estimation by the frequency of translocations is about 20-25 cGy. It seems reasonable in future to carry out cytogenetic examinations among the liquidators of the accident at the Chernobyl nuclear power plant using not only the classical and FISH methods but also new molecular-genetic methods permitting the estimation of remote genetic effects of radiation and their comparison with detected structural damage of the cell genome.

References

1. Awa A.A., T.Sofuni, T.Honda, M.Itoh, S.Neriishi, M.Otake. Relationship between the radiation dose and chromosome aberrations in atomic bomb survivors of Hiroshima and Nagasaki. *J.Rad. Res.*, 19, 126-140 (1978)
2. IAEA. Biological dosimetry: chromosomal aberration analysis for dose assessment. Technical Report N260.

International Atomic Energy Agency, Vienna (1986)

3. Lloyd D.C., A.A.Edwards, J.S.Prosser. Accidental intake of tritiated water: a report of two cases. *Radiat. Prot. Dosim.* 15, 191-196 (1986)
4. Romm H. And G.Stephan . Chromosome analysis – a routine method for quantitative radiation dose assessment. *Kerntechnik*, 55, 4, 219-225 (1990)
5. Salassidis K., E.Schmid, R.U.Peter, H.Braselmann, M.Bauchinger. Dicentric and translocation analysis for retrospective dose estimation in humans exposed to ionizing radiation during the Chernobyl nuclear power plant accident. *Mutation Res.*, 311, 39-48 (1994)
6. Snigiryova G., H.Braselmann, , K.Salassidis, V.Shevchenko, M.Bauchinger. Retrospective biodosimetry of Chernobyl clean-up workers using chromosome painting and conventional chromosome analysis. *Int. J. Radiat. Biol.* 71, 2, 119-127 (1997)
7. Stephan G., S.Pressel, G.Koshpessova, B.Gusev. Analysis of FISH-painted chromosome in individuals living near the Semipalatinsk Nuclear Test site. *Rad. Res.* 155, 796-800 (2001)
8. Bauchinger M., H.Braselmann, J.R.K.Savage, A.T.Natarajan, G.J.Terzoudi, G.E.Pantelias, F.Darroudi, M.Figgitt, G.S.Griffin, S.Knehr, N.D.Okladnikova, S.Santos, G.Snigiryova. Collaborative exercise on the use of FISH chromosome painting for retrospective biodosimetry of Mayak nuclear-industrial personnel. *Int. J. Radiat. Biol.*, 77, 3, 259-267 (2001)
9. Kodama Y., D.Pawel, N.Nakamura, D.Preston, T.Honda, M.Iton, M.Nakano, K.Ohtaki, S.Funamoto and A.A.Awa. Stable chromosome aberrations in atomic bomb survivors: result from 25 years of investigation. *Radiation Res.*, 156, 337-346 (2001)
10. Buchton K.E. Identification with G- and R-banding of the position of breakage points induced in human chromosomes by in vitro x-irradiation. *Int. J. radiat. Biol.*, 29, 475-488 (1976)
11. Tucker J.D., M.J.Ramsey, D.A.Lee, J.L.Minkler. Validation of chromosome painting as a biodosimeter in human peripheral lymphocytes following acute exposure to ionizing radiation in vitro. *Int. J. Radiat. Biol.*, 64, 1, 27-37 (1993)
12. Bauchinger M., E.Schmid, H.Braselmann, N.Willich, C.Clemm. Time-effect relationship of chromosome aberrations in peripheral lymphocytes after radiation therapy for seminoma. *Mutation Res.*, 211, 265-272 (1989)
13. Salassidis K., V.Georgiadou-Schumacker, H.Braselmann, P.Muller, R.U.Peter, M.Bauchinger. Chromosome painting in highly irradiated Chernobyl victims: a follow-up study to evaluate the stability of symmetrical translocations and the influence of clonal aberrations for retrospective dose estimation. *Int. J. Rad. Biol.*, 68, 257-262 (1995)
14. Lucas J.N., A.Awa, T.Straume, M.Poggensee, Y.Kodama, M.Nakano, K.Ohtaki, H.U.Weir, D.Pinkel, J.Gray, G.Littlefield. Rapid translocation frequency analysis in human decades after exposure to ionizing radiation. *Int. J.Radiat. Biol.*, 62, 53-63 (1992)
15. Lucas J.N., A.M.Chen, R.S.Sachs. Theoretical predictions on the equality of radiation-produced dicentrics and translocations detected by chromosome painting. *Int. J. Radiat. Biol.*, 69, 145-153 (1996)
16. Straume T., R.G. Langlois, J.Lucas, R.H.Jensen, W.Bigbee, A.T.Ramalho, C.E.Brandaomello. Novel dosimetry methods applied to victims of Goania Accident. *Health Physics*, 60, 71-76 (1991)
17. Natarajan A.T., S.J.Santos, F.Darroudi, V.Hadjidikova, Svermeulen, S.Chatterjee, M.Vanderberg, M.Grigorova, E.T.Sakamoto-Hojo, M.P.Curado. ¹³⁷Cesium-induced chromosome aberrations analysed by fluorescence in situ hybridization: eight years follow up of Goania radiation victims. *Mutat. Res.*, 400, 299-312 (1998)
18. Hagmar L., S.Bonassi, Strömberg, A.Brogger, L.Knudsen, H.Norppa and C.Reutermall. Chromosomal aberrations in lymphocytes predict human cancer – a report from European Study Group on Cytogenetic Biomarkers and Health (ESCH). *Cancer Res.* 58, 4117-4121 (1998)
19. Bonassi S., L.Hagmar, U.Stromberg, A.Huici Montagud, H.Tinnerber, A.Forni, P.Heikkilä, S.Wanders and H.Norppa. Chromosomal aberrations in lymphocytes predict human cancer independently of exposure to carcinogens. *Cancer Res.*, 60, 1619-1625 (2000)
20. Shevchenko V.A., G.P.Snigiryova Cytogenetic effects of the action of ionizing radiations on human populations. In: *Consequences of the Chernobyl Catastrophe: Human Health*. Moscow. 23-45 (1996)
21. Shevchenko V.A., E.A. Akaeva, I.M .Yeliseyeva, E.L. Iofa Human cytogenetic consequences of the Chernobyl accident. *Mutation Res.*, 361 (1996)
22. Birjukov A.P., V.K.Ivanov, A.F.Tsyb, S.I.Ivanov, N.E.Meskich, M.A.Maksjutov, Z.G.Kruglova, I.N.Ivanova,

- S.K.Bubnov. The main tendency of the morbidity of persons involved in recovery operation at the Chernobyl NPS. Proceeding of scientific conference "Results and tasks of retrospective medical monitoring at the group of persons affected by radiation as a results of the Chernobyl accident". Moscow, 18-24 (1998)
23. Apelt F., I.Kolin-Gerresheim, M.Bauchinger. Azathioprine a clastogen in human somatic cells? Analysis of chromosome damage and SCE in lymphocytes after exposure in vivo. *Mutation Res.*, 88, 61-72 (1981)
 24. Bauchinger M., E.Schmid, H.Zitzelsberger, H.Braselmann, U.Nahrstedt. Radiation-induced chromosome aberrations analysed by two-color fluorescence in situ hybridization with composite whole chromosome-specific DNA-probes and a pancentromeric DNA probe. *Int. J. Rad. Biol.*, 179-184 (1993)
 25. Gorbunova I.N., K.U.Ivanov, V.N.Nagiba, E.A.Nikanorova, O.S. Profe, T.I.Khaimovich, E.A.Akaeva, T.V.Elisova, E.L.Iofa, I.N.Nilova, L.N.Kostina, A.V.Rubanovich, V.A.Scevchenko, A.N.Bogomazova, G.A.Vilkina, N.N.Novitskaya, V.P.Kharchenko, E.D.Khazins, G.P.Snigiryova . Reconstruction of absorbed dose by the frequency of stable and unstable chromosome aberrations in nuclear specialists at distant periods after exposure. Proceeding of IV ISTC scientific advisory committee seminar, Novosibirsk, 370-377 (2001)
 26. Sevan'kaev A.V., D.C.Lloyd, A.A.Edwards and V.V.Moiseenko. High exposures to radaition received by workers inside the Chernobyl sarcophagus. *Radiation Protection Dosimetry*, 59, 2, 85-91 (1995)

The Follow-up Study of Chromosomal aberrations in Chernobyl Clean-up Workers

Natalia M. SLOZINA and Elizaveta G. NERONOVA

*All-Russian Center of Emergency and Radiation Medicine, EMERCOM of Russia,
Lebedeva 4/2, 194044, St.Petersburg, Russia: cytogen@ARCEM.spb.ru*

Abstract

A cytogenetic study was carried out on 359 clean-up workers who worked at the Chernobyl station in 1986-1989. The investigation was performed 6-12 years after irradiation. Chromosome type damages, i.e. double fragments, dicentrics and rings were significantly increased in the clean-up workers compared to the control. Chromatid exchanges were found only in the clean-up workers. A temporal change of radiation markers was also investigated based on the data of 243 persons who worked at Chernobyl in 1986. The temporal variation of dicentric frequency shows an inexplicable tendency towards the increase of dicentrics rate for the period of 8-12 years after irradiation. The association between the frequency of different types of chromosomal aberrations and such variables as smoking habits, coffee, tea, alcohol consumption, *etc.* was also analysed using a stepwise multiple regression analysis. A statistically significant association was only observed between smoking and chromatid exchanges. This type of aberrations was significantly higher in the smoking subgroup than in the non-smoking subgroup of the clean-up workers. The fact of an increased level of unstable chromosomal aberrations in a remote period after irradiation allows us to suppose that other pathways of genomic burden may exist in addition to straight radiation action at the time of irradiation.

Introduction

Chromosome damage induced in human lymphocytes is often considered a sensitive indicator of radiation exposure [1-3]. An increased level of structural chromosomal aberrations in the clean-up workers soon after the Chernobyl accident has been reported [4,5]. It is known that the frequency of radiation markers (dicentric and ring chromosomes) decreases in time [6,7]. So, it is expected that the frequency of chromosomal aberrations (CA) in the clean-up workers, who suffered from low doses of radiation, would become as low as the control level some years after the accident. However, increased rate of chromosomal aberrations in the clean-up workers was demonstrated 4-6 years after the Chernobyl accident [8-11]. A follow-up study of Chernobyl clean-up workers has been carried out at All-Russian Centre of Emergency and Radiation Medicine Emercom of Russia (ARCERM) since 1992 in order to assess the consequences of low doses of ionising radiation on their health. Cytogenetical investigation was carried out simultaneously with clinical examination.

The goal of this paper is to present the results of the follow-up study of cytogenetical damage in the peripheral blood lymphocytes from the clean-up workers in a remote period (6-12 years) after the Chernobyl accident.

Materials and methods

A cytogenetic study was carried out on 359 clean-up workers who worked at the Chernobyl station in 1986-1989. The investigation was performed 6-12 years after irradiation. 281 persons had official dose of irradiation, estimated by dosimetric service at Chernobyl. Most of them received up to 25 cGy, but 30 persons received from 25.1 cGy to 100 cGy. Thus, the mean dose of irradiation for clean-up workers who

worked at the station in 1986 was 20.3 ± 1.01 cGy; 13.4 ± 1.71 cGy for clean-up workers of 1987 and 5.2 ± 0.88 cGy for clean-up workers, who worked at the station in 1988-89.

The control group comprised 48 persons matched for similarity of age and health status, with no history of irradiation.

Lymphocyte cultures (48 h) were set up. Culture medium consisted of RPMI 1640 (Sigma) supplemented with 15% fetal bovine serum (Sigma), phytohemagglutinin P (Difco), antibiotic. 5-Bromodeoxyuridine was added 24 h from the beginning of cultivation at a final concentration of $10 \mu\text{g/ml}$ to permit fluorescence plus Gimsa staining so that cells could be scored at the first in vitro metaphase. Chromosome preparation was stained by standard procedures. At the beginning of our investigations we analyzed no less than 100 metaphases per individual. Later the number of metaphases was increased to 200-500. Cells with 45-46 chromosomes were analyzed. All types of unstable chromosome aberrations (CA) were analysed: chromatid breaks (discontinuities more than the weight of a chromatid and without visible connecting material), chromatid exchanges (tri- and quadriradials), acentric fragments, dicentrics and rings were registered.

For micronucleus test cytochalasin B (Sigma), at the final concentration of $6 \mu\text{g/ml}$, was added within the last 28 h to the cultures to be harvested for micronuclei, and the total cultivation time was 72 h. At least 500 cytokinesis-blocked binucleated cells for each individual were scored in the micronucleus test.

For all subjects, modified questionnaires, based on the method proposed by Carrano and Natarajan [12], were filled in.

During the 6-yr period of observation the same microscopists performed cytogenetic investigations. All slides were coded and distributed between two microscopists.

For each group dicentrics and rings yields from each individual were tested for homogeneity using the chi-squared test. Mean yields and their standard errors were calculated taking into account any lack of homogeneity. Average values were weighted taking into account different number of cells per person. Various statistical methods (ANOVA test, chi-squared test, stepwise multiple regression analysis, Spearman Rank correlation test) were used according to the nature of data and type of analysis needed. Calculations were performed with a software package, Statistics for Windows.

The frequencies of various types of chromosome aberrations in the clean-up workers

The main frequencies of various types of chromosome aberrations are given in Table 1 along with

Table 1. Frequencies of chromosomal aberrations in the clean-up workers and the control individuals (1992-1998).

	Clean-up workers	Control
Number of individuals	359	48
Total number of cells scored	50771	7175
Aberrant cells (%)	2.71 ± 0.13	2.08 ± 0.25
Chromatid breaks (%)	1.36 ± 0.09	1.59 ± 0.23
Chromatid exchanges (%)	0.15 ± 0.03^a	0.00 ± 0.02
Chromosome breaks (%)	0.84 ± 0.06^a	0.42 ± 0.11
Dicentrics, rings (%)	0.25 ± 0.03^b	0.03 ± 0.02
Atypical chromosomes (%)	0.12 ± 0.02	0.03 ± 0.03

^a Significantly greater frequency than in control at the 0.05 level of significance. ^b at the 0.01 level of significance.

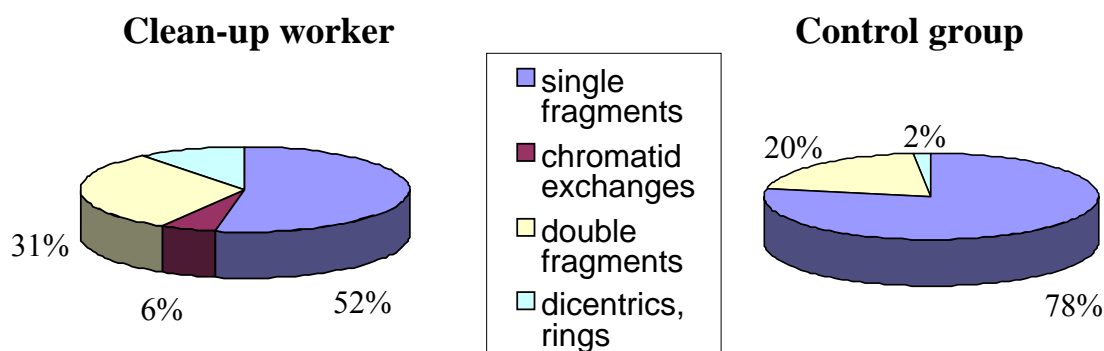

Figure 1. The spectrum of chromosomal aberrations in the clean-up workers and control group.

their standard errors. These data was obtained from blood taken 6-12 years after irradiation. The total frequency of chromosomal damage in the clean-up workers, whilst being higher than the controls, was not so high as at the 5% criterion for significance. The total damage was dominated in both groups by single or chromatid breaks, which, whilst being higher in the controls, were again not significantly in excess. Chromosome type damages, i.e. double fragments, dicentric and rings significantly increased in the clean-up workers. Chromatid exchanges were found only in the clean-up workers. The ratios of various types of chromosomal aberrations in two groups are given in Figure 1.

It is possible to see in Fig 1 that the predominant type of damage in the controls is chromatid aberrations (78%), whilst double fragments comprise 20% and dicentric and rings 2%. The relative proportion of chromatid aberrations in the clean-up workers is lower at 58%. The chromosome types are higher at 42% of which 11% are dicentric and rings.

Table 2 indicates a significantly larger proportion of individuals with dicentric and rings, and with chromatid exchanges in the clean-up workers than in the controls.

The micronucleus (MN) test in the clean-up workers

The MN test were performed simultaneously with CA investigations. For 22 clean-up workers and 14 controls (presented in Table 1) MN and CA assays were used in parallel on peripheral blood lymphocyte cultures.

Table 3 presents the frequency of MN and CA in the clean-up workers and in the controls. Analysis of Table 3 shows that the clean-up workers and the controls do not differ in terms of MN test, while the

Table 2. Frequency of individuals with exchange aberrations.

Type of exchange aberrations	359 clean-up workers Number of subjects (%)	48 controls Number of subjects (%)
Dicentric + rings	95 (26.4) ^a	3 (6.2)
Chromatid exchanges	58 (14.7) ^a	0 (0)

^aSignificantly exceeds the control value at the 0.01 level of significance.

Table 3. Results of the analysis of MN and CA assay in parallel cultures.

	Clean-up workers	Control
Number of individuals	22	14
MN frequency (%)	1.23 ± 0.12	1.06 ± 0.17
CA frequency (%)	2.18 ± 0.31 ^a	1.00 ± 0.23

^aSignificantly exceeds the control value at the 0.01 level of significance.

rate of CA is significantly higher in the clean-up workers.

The results of micronucleus test did not demonstrate significantly higher damage in the clean-up workers than in the controls. Kolubaeva et al. [13] and Wuttke et al. [14] also could not find an increase in micronucleus frequency 5 years after the Chernobyl accident. So these data could be provided as an argument for that the application of the micronucleus test as a cytogenetic monitor of radiation effects in a remote period is not effective. The chromosomal aberration test was found to be more sensitive than the MN assay as a cytogenetic monitor of the remote radiation effects.

The temporal changes of radiation markers in the clean-up workers

A total of 243 persons who worked at Chernobyl in 1986 were selected from database in order to consider the temporal changes of radiation markers. Clean-up workers were divided into 6 groups according to time of blood sampling. The data is presented in Table 4.

As it can be seen from the data presented in Table 4, frequency of dicentrics and rings did not decrease during the 6 year period of observation and exceeded the control level even 12 years after irradiation.

There is a commonly held opinion that the frequency of unstable chromosomal aberrations in lymphocytes decreases with the time from irradiation. There are some publications devoted to the estimation of lifespan of human lymphocytes and temporal changes in the yield of chromosomal aberrations [7,15-17]. The most common opinion is that the half-life of lymphocytes is about 3 years [18]. If so, it means that the initial frequency of chromosomal aberrations decreases by half in 3 years. Schevchenko and co-authors [19] have published that the initial yield of chromosomal aberrations in the Chernobyl clean-up workers estimated in 1986 soon after the irradiation in different groups was: 0.27 ± 0.10 dicentrics per 100 cells in a group of medical personnel, 0.32 ± 0.08 in drivers, 0.44 ± 0.09 in builders of sarcophagus and 0.48 ± 0.17 in dosimetrists. Therefore, taking into account the suggested half-life of lymphocytes, one would suppose the frequency of dicentrics and rings of 12 years, ie. four half-lives, after irradiation has returned to essentially the control level.

However, the results of our investigation lead to a conclusion that 6-12 years after the irradiation the yield of dicentrics and rings did not decrease to the control value. The existence of a residual level of induced dicentrics and rings at long times, ie. decades, after irradiation has been reported although these have generally been observed in persons exposed to high doses of radiation [7, 20-25]. Few data have been reported on exposure to low doses. Thus a particular interest is imposed on our own investigations

Table 4. Dicentrics and rings frequency in clean-up workers by the years after the accident and homogeneity testing on individuals within the year bands

Years after the accident	Number of subjects	Number of cells	Number of Dic+Rings (Rings)	Chi-squared	DF	Yield \pm SE (per 100 cells)
6	14	1573	2 (0)	8.23	13	0.13 ± 0.07
8	100	10180	25 (1)	146.13	99	$0.25 \pm 0.05^*$
9	63	11869	29 (7)	80.11	62	$0.24 \pm 0.04^{**}$
10	35	5821	26 (4)	35.89	35	$0.45 \pm 0.10^{***}$
11	12	2125	10 (1)	14.42	11	$0.47 \pm 0.15^{***}$
12	19	3711	14 (3)	20.52	18	$0.38 \pm 0.12^{***}$
control	48	7175	3 (0)	41.55	47	0.04 ± 0.02

Difference of the yield of dicentrics and rings between the clean-up workers and the control group is significant at * - $p < 0.05$, ** - $p < 0.01$ and *** - $p < 0.001$ levels.

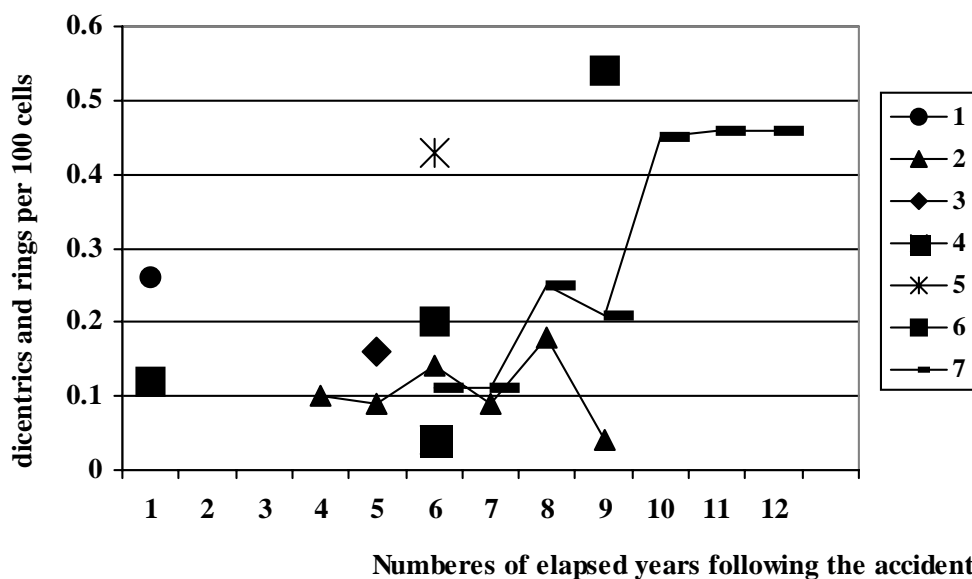

Figure 2. The yield of dicentric chromosomes and rings determined in clean-up workers in elapsed different years after the accident (the data of literature).

- | | | |
|----------------------------------|----------------------------------|--------------------------------|
| 1. Semov et al., 1994 [4] | 2. Schevchenko et al., 1995 [19] | 3. Snigireva et al., 1994 [28] |
| 4. Pilinskaya et al., 1994 [26] | 5. Lazutka, 1996 [29] | 6. Komar et al., 1997 [30] |
| 7. Slozina et al., present paper | | |

which were carried out on a large group of such persons. Analysis of our data and the values reported by other laboratories who also examined the frequency of unstable chromosomal aberrations in the clean-up workers at different times after the Chernobyl accident [26-31] suggest that the levels of dicentric chromosomes found long afterwards is close to the initial levels reported in the studies carried out immediately after the accident. This is depicted in Figure 2, showing that the yields of dicentric chromosomes in the post-irradiation period do not become lower than the initial value (with only one exception; a point determined by Shevchenko et al. [19]). Later, an increased level of dicentric chromosomes was again found by this research group (personal communication).

In our investigation we found some temporal variation of dicentric frequency, which shows an inexplicable tendency towards the increase of dicentric rate, 8-12 years after irradiation (Table 4 and Fig.2). No differences are seen in the scenario of irradiation, health status or the life style factors among the groups of people in different years of observation.

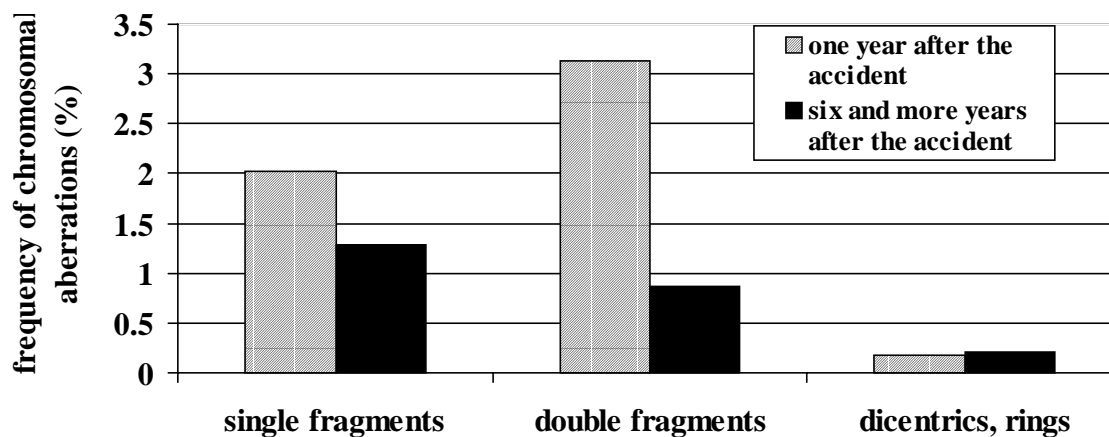

Figure 3. Frequency of chromosomal fragments and dicentric chromosomes + rings 1 year and 6-10 years after the Chernobyl accident.

We analysed temporal changes of chromosomal and chromatid fragments, the initial data of which had been obtained 1 year after the Chernobyl accident [32].(Fig 3). The frequencies both of single fragments and double fragments have clearly decreased 6-10 years after the accident.

It could be possible to put forward some suppositions about the persistence of dicentrics in the clean-up workers:

Long-life lymphocytes

Most lymphocytes have a half-life of about 3 years; however, some lymphocytes have a life span of several decades [6]. So it is possible to suppose that some asymmetrical exchanges have been found in long-life lymphocytes.

Stem cells

Although the clean-up workers were exposed to relatively low doses of ionising radiation, blood stem cells were also exposed to external γ -irradiation. Some stem cells may survive many decades without undergoing proliferation and start to divide several years after irradiation. So it is possible that a part of dicentrics arises from these cells. It is also known that some dicentric chromosomes are able to pass through mitosis successfully and persist through cell divisions [33]. We cannot exclude that a certain fraction of the dicentrics is permanently produced by blood stem cells.

Radionuclides deposited

Several studies have shown that radioisotopes may cause chromosomal damage in peripheral lymphocytes after incorporation in man [34,35]. Radionuclides might have been incorporated by the clean-up workers during the accident. Some radioactive compounds have long physical half-lives and are retained in the body for a long period of time. So we cannot rule out the possible effects of internally deposited radioactive materials on chromosome aberrations in a remote period after the Chernobyl accident.

Chromosomal instability

It is also possible to assume that chromosomal instability could be induced by ionising radiation [36].

Association between the frequency of different types of chromosomal aberrations and the questionnaire information

The association between the frequency of different types of chromosomal aberrations and such variables as smoking habits, coffee, tea, alcohol consumption, history of current chronic illnesses, use of medicines and diagnostic X-rays was also analysed using stepwise multiple regression analysis in a group of clean-up workers. On the occasion to collect blood sample and fill out the questionnaire, we had the opportunity to inquire the doner whether he had specific anamnestic or environmental factors responsible for the existence of cytogenetic markers No statistically significant associations were observed due to any of these parameters except smoking. We have found the association of smoking with chromatid exchanges.

Table 5. Comparison of smoking and non-smoking liquidators.

	Smokers	Non-smokers
Number. of individuals	60	39
Total number. of cell scored	10071	6726
Aberrant cells (%)	2.97 ± 0.31	2.28 ± 0.34
Chromatid breaks (%)	1.13±0.19	0.96±0.21
Chromatid exchanges (%)	0.29 ± 0.07 ^a	0.03 ± 0.02
Chromosome breaks (%)	0.92 ±0.12	0.70 ± 0.12
Dicentrics, rings (%)	0.52 ± 0.09	0.31 ± 0.09
Atypical chromosomes (%)	0.08 ± 0.03	0.28 ± 0.13

^aSignificant at the 0.001 level.

This type of aberrations was significantly higher in the smoking subgroup than in the non-smoking subgroup of the clean-up workers (Table 5).

Although most chemical agents induce chromatid-type aberrations, the frequencies of chromatid exchanges are reported to be rare even in the smokers [37,38]. Concerning the high frequency of chromatid exchanges observed among the smokers in the Chernobyl clean-up workers, we cannot rule out the possible synergistic effects of smoking and previous radiation exposure.

The persistence of dicentrics and reconstructing doses

The long time persistence of dicentrics and rings should be considered in relation to the possibility to use the data for retrospective dose reconstruction. As an illustration, we have attempted to reconstruct the radiation doses using the yields of dicentrics and rings per cell obtained 6, 9, 12 years after irradiation. Assuming the half-life of lymphocytes 3 years [18] and taking account of the time between the irradiation and blood sampling we calculated what the initial frequency of dicentrics and rings could have been. Doses were then calculated using an *in vitro* calibration curve; $Y=0.0005+1.64*10^{-4}*D+4.92*10^{-6}*D^2$ taken from IAEA, 1986 [39]. The dose calculated 6 years after irradiation (~160mGy) is in a good agreement with the dose estimated in a similar group of clean-up workers soon after irradiation [40]. The dose derived 9 years after irradiation (~480mGy) seems a little overestimated, whilst the data derived 12 years after radiation exposure (~980mGy) is quite unrealistic for this cohort.

Conclusion

Results of these long-term investigations of so-called unstable chromosomal aberrations in the clean-up workers who suffered from low doses of ionizing radiation at Chernobyl suggest that the yield of dicentrics and rings does not change significantly over a long period of time following irradiation. This is an unexpected finding because it is at variance with the commonly accepted view of the persistence of dicentrics.

The results reported here demonstrate the presence of elevated chromosomal disturbances in lymphocytes of the clean-up workers in a remote period after the Chernobyl accident. Follow-up studies on individuals exposed to genotoxic agents have clearly demonstrated the predictive value of high chromosomal damage for subsequent cancer risk [41,42]. The fact of an increased level of unstable chromosomal aberrations in a remote period after irradiation allows us to suppose that other pathways of genomic burden may exist in addition to straight radiation action at the time of irradiation.

Considering the results of our investigations, we can conclude that the clean-up workers represent a high risk group that deserves special medical monitoring.

References

1. Zoetlief J. and Broerse J., Dosimetry for radiation accidents: present status and prospects for biological dosimetry, *Int. J. Radiat. Biol.*, 57 (1990) 737-750.
2. Multer W.-U., Streffer C., Biological indicators for radiation damage. *Int. J. Radiat. Biol.* 59 (1991) 863-873.
3. Verschaeve L., Comparison of cytogenetic methods for biological biodosimetry of radiation exposure. *Nucleus* 36 (1993) 1-12.
4. Semov A.V. et al., Dose dependence of chromosome aberration induction in ameliorators of the Chernobyl accident, *Radiat. Biol. Radiat. Ecol.* 34 (1994) 865-871.
5. Shevchenko V.A. et al., The cytogenetic effects in persons who suffered as a result of the accident at the Chernobyl Atomic Electric Power Station, *Radiat. Biol. Radiat. Ecol.* 35 (1995) 646-654.
6. Bender M.A. et al., Current status of cytogenetic procedures to detect and quantify previous exposures to radiation. *Mutation Res.* 196 (1988) 103-159.
7. Ramalho A. et al., Lifespan of human lymphocytes estimated during a six year cytogenetic follow-up of individuals accidentally exposed in the 1987 radiological accident in Brazil, *Mutation Res.* 313 (1995) 47-54.

8. Pilinskaya M.A. et al., Cytogenetic indication of irradiation in person!, influenced by the Chernobyl accident, *Cytol. Genet.* 26 (6) (1992) 6-9 (in Russian).
9. Frolov V.M. et al., The cytogenetic disorders in the people who took part in the clean up of the sequel at the Chernobyl Atomic Electric Power Station and who lived continuously in areas with an unfavourable ecological situation, *Cytol. Genet.* 27 (4) (1993) 14-19 (in Russian).
10. Vorobtsova I.E. et al., Cytogenetic examination of ameliorators performed in different times after the Chernobyl accident, *Radiat- Biol. Radioecol.* 34 (1994) 798-803 (in Russian).
11. Lazutka J.R., Chromosome aberrations and rogue cells in lymphocytes of Chernobyl clean-up workers. *Mutation Res.* 350 (1996) 315-329.
12. Carrano A.V. and Natarajan A.T., International commission for protection against environmental mutagens and carcinogens. ICPEMC Publications No. 14 Considerations of population monitoring using cytogenetic techniques. *Mutation Res.* 204 (1988) 379-406.
13. Kolubaeva S.N. et al., The study of irradiation damages in peripheral blood lymphocytes by micronucleus and chromosome analysis. *Radial Biol. Radioecol.* 35 (1995) 150-156 (in Russian).
14. Wuttke K. et al., Micronuclei in lymphocytes of children from the vicinity of Chernobyl before and after ¹³¹I therapy for thyroid cancer. *Int. J. Radiat. Res.* 69 (1996) 259-268.
15. Scheild W. et al., Chromosomal aberrations induced in human lymphocytes by an X-radiation accident: results of a 4-year postirradiation. *Int.J.Radiat.Biol.* 54 (1988) 395-402.
16. Bauchinger M. et al., Time-effect relationship of chromosome aberrations in peripheral lymphocytes after radiation therapy for seminoma. *Mutation Res.* 211 (1989) 265-272.
17. Bogen K.T., Reassessment of human peripheral T-lymphocyte lifespan deduced from cytogenetic and cytotoxic effects of radiation. *Int.J.Radiat.Biol.* 64 (1993) 195-204.
18. Bukton K.E. et al., Lymphocyte survival in man treated with X-rays for ankylosing spondilitis. *Nature.* 214 (1967) 470-473.
19. Shevchenko V.A. et al., Human cytogenetic consequences of the Chernobyl accident. *Radiation Biology, Radiation Ecology* 35 (1995) 646-654 (in Russian).
20. Goh T.O., Total-body irradiation and human chromosomes: cytogenetic studies of the peripheral blood and bone marrow lymphocytes seven years after total-body irradiation. *Radiation Res.* 35 (1968) 155-176.
21. Goh T.O., Total-body irradiation and human chromosomes IV. Cytogenetic follow-up studies eight and ten and one half years after total-body irradiation. *Radiation Res.* 62 (1975) 364-373.
22. Sasaki M.S. and Miyata H., Biological dosimetry in atomic bomb survivors. *Nature* 220 (1968) 1189-1193.
23. Awa A.A. et al., Relationship between the radiation dose and chromosome aberrations in atomic bomb survivors of Hiroshima and Nagasaki. *J. of Rad. Res.* 19 (1978) 126-140.
24. Ishihara T. et al., Human cytogenetic studies at the National Institute of Radiological Sciences, Japan, 1963-1988. *Cancer Genet. Cytogenet.* 45 (1990) 13-35.
25. Ramalho A.T. et al., Results of a cytogenetic follow up study 7.5 years after ¹³⁷Cs exposure at the Goyania (Brazil) radiological accident. *Radiat. Protect. Dosimetry* 64 (1996) 3119-321.
26. Pilinskaya M.A. et al., Cytogenetical monitoring of persons who suffered in Chernobyl station accident. *Cytology and Genetics* 28 (1994) 18-25 (in Russian).
27. Semov A.V. et al., Dose dependence of chromosome aberration induction in ameliorators of the Chernobyl accident. *Radiation Biology, Radiation Ecology* 34 (1994) 865-871 (in Russian).
28. Snigireva G.P. et al., Results of cytogenetical investigation clean-up workers of the Chernobyl accident. *Haematology and Transfusiology* 39 (1994) 19-21 (in Russian).
29. Lazutka J.R., Chromosome aberrations and rogue cells in lymphocytes of Chernobyl clean-up workers. *Mutation Res.* 350 (1996), 315-329.
30. Komar V.E. et al., Special features of radiation effects in Chernobyl victims revealed by cytogenetic methods at different stages after the accident. In *One decade after Chernobyl. Summing up the consequences of the accident.* IAEA, September 1997, 11-14.
31. Slozina N. et al., Increased level of chromosomal aberrations in lymphocytes of Chernobyl clean-up workers 6-10 years after the accident. *Mutation Res.* 379 (1997) 121-125.
32. Slozina N.M., et al., Studying of genome instability of sick clean-up workers in the remote period after Chernobyl accident, in: A.M. Nikiforov (Ed.), *Low doses of ionizing radiation. clinical and radiation-hygienic*

- consequences of Chernobyl accident, St. Petersburg, 1996. pp. 112-116 (in Russian).
33. Boei J.J.W.A. et al., Detection of chromosomal aberrations by fluorescence in situ hybridisation in the first three postirradiation divisions of human lymphocytes. *Mutation Res.* 349 (1996) 127-135.
 34. Littlefield L.G. and Lushbaugh C.C., Cytogenetic dosimetry for radiation accidents - the good, the bad, and the ugly, in: R.C. Ricks. S.A. Pry (Ed.) *The Medical Basis for Radiation Accident Preparedness II. Clinical Experience and Follow-up since 1979*, Elsevier. (1990) New York, pp. 461-478.
 35. Okladnikova N.D. et al., Cytogenetic effect of prolonged occupational exposure to incorporated plutonium-239 and external gamma-irradiation (clinical study). *Med. Radiol. Radiat. Saf.* 5 (1994) 48-52 (in Russian).
 36. Morgan W.F. et al., Genomic instability induced by ionizing radiation *Radiat. Res.* 146 (1996) 247-258.
 37. Bender M.A. et al., Chromosomal aberration and sister-chromatid exchange frequencies in peripheral blood lymphocytes of a large human population sample. *Mutation Res.* 204 (1988) 421-433.
 38. Obe L. et al., Variability of chromosomal aberrations in human peripheral lymphocytes of smokers and nonsmokers, in: G. Obe, A.T. Natarajan (Ed.), *Chromosomal Alterations: Origin and Significance*, Springer-Verlag, (1994) Berlin, pp. 307-318.
 39. IAEA. Biological dosimetry: chromosomal aberration analysis for dose assessment. Tech.Report N.260, International Atomic Energy Agency, Vienna, 1986.
 40. Iljichev S.V. et al., Retrospective dosimetry in clean-up workers of the Chernobyl accident. Kiev, 1996. 234p. (in Russian).
 41. Hagmar L. A. et al., Cancer risk in human predicted by increased level of chromosomal aberrations in lymphocytes: Nordic study group on the health risk of chromosome damage. *Cancer Res.* 54 (1994) 2919-2922.
 42. Bonassi S. et al., Are chromosome aberrations in circulating lymphocytes predictive of future cancer onset in humans?. *Cancer Genet. Cytogenet.* 79 (1995) 133-135.

Chromosomal Aberrations in Blood Lymphocytes of the Residents of 30-km Chornobyl NPP Exclusion Zone

Larysa BEZDROBNA, Tetyana TSYGANOK, Olena ROMANOVA, Larysa TARASENKO,
Volodymyr TRYSHYN, Ludmila KLIMKINA

*Institute for Nuclear Research, National Academy of Science of Ukraine,
Prospekt Nauki, 47, Kyiv-28, 03680, Ukraine: tel.+380 –44-265-47-36, interdep@kinr.kiev.ua*

Abstract

A comparative cytogenetic examination of 33 self-settlers in the 30 km ChNPP Exclusion Zone and 31 residents in villages of Yahotyn district, Kyiv region was carried out in 1998-99. The levels of soil contamination of their residential areas with ^{137}Cs , ^{90}Sr and $^{238,239+240}\text{Pu}$ were 74–477 kBq/m², 33–288 kBq/m² and 1.5-10.0 kBq/m², respectively for the former, and 1.9–5.8 kBq/m², 0.6–2.8 kBq/m² and 0.01-0.05 kBq/m², respectively for the latter. Using various data about the radiation situation in the Exclusion Zone, the effective doses on whole-body of the self-settlers were estimated to be 30–333 mSv for the whole residing period after the accident. The mean frequencies of aberrant cells and chromosomal aberrations for the Zone self-settlers were significantly higher than those for the residents in Yahotyn district, while the values of the latter group were found to be above the spontaneous levels reported in literatures. The individual variability in the distribution of the same indices was significantly larger for the self-settlers than for the Yahotyn residents. The compared groups also differ in the distribution of aberrations in cells. A repeated examination of 20 Zone self-settlers was conducted in 2001. A significant decrease in chromosome type aberration frequency was found at the expense of fragments frequency decrease. However, the total frequency of chromosomal aberrations didn't differ in 1998-99 and in 2001.

INTRODUCTION

After the Chornobyl accident on 26th of April 1986, the territory within a 30-km radius from ChNPP was separated as Exclusion Zone. The people residing in this area were evacuated during 4-7th of May. However, right from the first days and weeks after the evacuation some people have been returning to the Zone villages without permission. In addition, nearly 100 people were not evacuated at all. They are called “self-settlers”. The number of them was about 500 people in 1986 in the Ukrainian part of the Exclusion Zone territory, 1200 – in 1988, 660 – in the end 1998 and 477 – in 2001. Up to 80 % of them are old age pensioners. They lead relatively isolated life, farm and consume mostly food products grown in Zone, which determines their permanent external and internal irradiation.

It is a well-known fact that one of the most significant effects of radiation is destabilization of genetic structures of somatic cells leading to an increase in the risk of somatic diseases, first of all, of cancers. In order to investigate the efficiency of long-term permanent suprabackground radiation in the conditions of Exclusion Zone we have been conducting periodically cytogenetic examinations of self-settler groups from 1995. The first examination was carried out using micronucleus test on cultures of peripheral blood lymphocytes. A significant increase was revealed in the micronuclei frequency in cells of the Zone self-settlers of the age up to 55, compared to that of Kyiv residents of the same age [1,2]. These findings pointed out an expediency of further investigations. In this work we present the results of chromosomal aberration frequency in blood lymphocytes of ChNPP Exclusion Zone residents investigated in the end of 1998 – beginning of 1999, and in 2001.

SUBJECTS AND METHODS OF STUDY

The subjects of examination

In 1998-1999 we examined 33 people residing in the villages in Exclusion Zone, located northwestward (Stari Shepelychi, Rudnya Illinetska, Lubyanka) and southeastward (Opachychi, Kupovate, Horodyshe, Paryshiv) of ChNPP. These people returned to their homes in Exclusion Zone mostly in June 1986 - April 1987 after the evacuation. For comparison we have simultaneously examined 31 people (control group) from the inhabitants of the villages in Yahotyn district, Kyiv region. The climatic and socioeconomic conditions as well as health care of both examined groups were analogous. Table 1 represents the data on the radionuclide contamination in soil of residing areas of the people observed. The group of comparison was formed to match age, sex and smoking status of the ChNPP Exclusion Zone self-settlers (Table 2). None of the persons of the control group had had any conscious contact with radiation factor except for routine medical radiological diagnostic procedures and had not been exposed to chemotherapy. In 2001 20 people among the 33 Zone self-settlers observed in 1998-1999 were repeatedly examined. At the moment of obtaining of blood samples no one from those examined had any acute illness or exacerbation of chronic diseases. The participation in examination was voluntary. A special questionnaire was offered to the examined persons and all data obtained were entered into a database.

The cytogenetic protoco

Venous blood samples were obtained in field conditions, either in the places of residence of the

Table 1. Density of radionuclide contamination in soil in ChNPP Exclusion Zone and villages in Yahotyn district, Kyiv region, kBq/m².

Region	Inhabited locality	¹³⁷ Cs	⁹⁰ Sr	^{238.239+240} Pu
ChNPP Exclusion Zone	Rudnya Illinetska	129.5±25.9	70.3±22.2	1.5
	Lubyanka	407.0±101.7	144.3±31.7	5.9
	Stari Shepelychi	477.3±118.9	288.6±85.1	10.0
	Paryshiv	115.4±22.0	54.0±11.3	2.2
	Opachychi	214.6±59.2	133.2±25.9	5.6
	Kupovate	107.0±22.2	44.4±14.8	3.0
	Horodyshe	74.0±14.2	33.3±6.3	2.6
Yahotyn district, Kyiv region	Sulymivka, Chernyakhivka	1.9 – 2.9	0.64	0.01
	Lozovyi Yar, Chervone	2.6	0.96	0.04
	Panfily	5.0	0.8	0.04 – 0.1
	Kapustyntsi	5.0	0.8	0.02 – 0.04
	Yahotyn	2.9 – 5.8	0.9 – 2.8	0.03 – 0.05

Table 2. Characteristics of examined groups.

Group	Range of effective equivalent doses, mSv		Number of persons	Age (range, mean), in years	Sex		Smoking status	
	Whole body	Red bone marrow			F	M	Non-smokers	Smokers
ChNPP Exclusion Zone	30 – 333	13 - 630	33	24 – 68 53.9±1.7	17	16	28	5
Yahotyn district, Kyiv region	-	-	31	23 – 72 51.5±2.2	18	13	26	5

examined people or in rural outpatient clinics. All samples were drawn into vacutainers containing heparin as anticoagulant. Samples were transported within eight hours in Kyiv to Laboratory of Radiobiology of Institute for Nuclear Research, National Academy of Science of Ukraine.

Lymphocytes culture and cytogenetic slide preparation were conducted according to [3]. 0.25 ml of whole-blood have been cultivated in 3 ml of RPMI-1640 medium supplemented with 15% fetal bovine serum with 1.5 % phytohaemagglutinin-P (Sigma, USA) for 48 h at 37°C in darkness. Colchicine in final concentration of 7.5mg/ml was added to the culture 3 hours prior to fixation. The slides were prepared following a standard technique, using for hypotonia - 75mM solution of KCl and for fixation – ethanol-acetic acid (3:1), for chromosome staining - Giemsa stain (2 % solution). All slides were encoded. The slides were studied with oil immersion using x900 magnification. On the average 380 metaphases meeting the required standards from every person were studied. Analysis was conducted by means of visual partial karyotype determining. We counted all chromatid type aberrations including chromatid fragments and chromatid exchanges, and all chromosome type ones, such as paired acentric fragments (including isochromatid deletions), interstitial deletions, dicentric chromosomes (*dic.*) and centric rings (*c.r.*), abnormal monocentrics, which could emerge as the result of terminal and interstitial deletions, reciprocal translocations and insertions. The blank gaps were not taken into account.

Doses estimation

Individual effective equivalent irradiation doses (both external and internal on whole body and red bone marrow) of the Zone self-settlers were determined by calculational methods. Dose reconstructing was based on the data of the mean density of soil contamination of residential areas with radionuclides of ^{137}Cs , ^{90}Sr , $^{238,239,240}\text{Pu}$ and ^{241}Am together with the time and duration of personal residence in Zone in the post-accident period. Also the data were used from representative measurements of exposure dose rate in houses and homesteads; ^{137}Cs and ^{90}Sr content in nutritional products of local origin; individual ^{137}Cs content in the bodies of examined people measured by a whole body counter.

Statistical Analysis

Characteristic distribution of chromosomal aberrations among the examined persons was determined by means of χ^2 test. Significance of the differences between the groups was estimated with χ^2 -test, Wilcoxon-Mann-Whitney U-test, Students t-criterion and Fisher test. Age-relation was estimated by means of the Spearman ranks correlation coefficient [4,5].

RESULTS AND DISCUSSION

Cytogenetic examination in 1998-1999

Frequency of aberrant cells and chromosomal aberrations:

Distribution of the examined persons by the number of chromosomal aberrations per 100 analyzed lymphocytes is shown in Fig. 1. The obtained distributions fit the normal type in both of the Zone self-settlers and the village residents of Yahotyn district: for the Yahotyn district group – $\chi^2 < \chi^2_{0.01}$ and for the Zone group – $\chi^2 < \chi^2_{0.05}$. As is seen from the bar chart (Fig. 1), one third of the Zone self-settlers showed the frequency of chromosomal aberrations exceeding the maximum value of this parameter in the comparison group. The comparison of individual distributions by the number of aberrant cells and chromosomal aberrations per 100 cells showed a significant difference between two groups ($\chi^2 > \chi^2_{0.01}$). However, the comparison utilizing the U-criterion revealed that the distribution of persons by the chromosomal aberrations frequency statistically significantly differs in two groups only when the results of persons younger than 60 years old were compared ($p < 0.001$). The inter-individual variation (dispersion) and the mean group frequency of aberrant cells and chromosomal aberrations in peripheral blood lymphocytes were significantly higher for the Zone self-settlers than for the Yahotyn district inhabitants (Table 3). V.Yu. Nugis [6] observed that the increase of individual variation in frequencies of

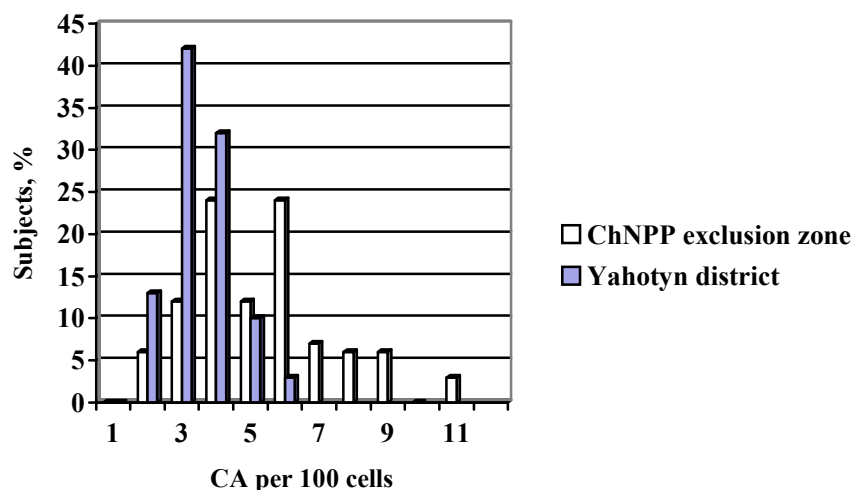

Fig. 1. Distribution of examined persons by the number of chromosomal aberrations (CA) per 100 cells.

chromosomal damages in the population signals chronic exposure to genotoxic factors. It is noteworthy that higher levels of aberrant cells (3.20 ± 0.15 %) (mean \pm SEM, here and below) and chromosomal aberrations (3.51 ± 0.17 %) than those usually reported for the "clean" regions were found in the inhabitants of the Yahotyn district. According to a generalized data on the spontaneous level of mutagenesis for the year 2000 reported by our Russian colleagues, the frequencies of aberrant cells and chromosomal aberrations in blood lymphocytes are 2.13 ± 0.08 % and 2.21 ± 0.14 %, respectively [7]. The data of the same authors also indicates that the mean frequency of chromosomal aberrations in the early 70-th was 1.19 ± 0.06 % [8]. A generalized cytogenetic monitoring of healthy population of Ukraine up to 1986 testifies that before the Chernobyl accident the frequency of aberrant cells and chromosomal aberrations in peripheral blood lymphocytes of the Ukrainian population were 1.43 ± 0.16 % and 1.47 ± 0.19 %, respectively [9]. The above allows us to assume that the registered parameters of mutagenesis in Yahotyn district are caused not only by the age of the examined persons (65% of them were 50+ according to Zone self-settlers group age structure), but also by general deterioration of the environment during the period after 1986.

Two persons from the Exclusion Zone and one Yahotyn district resident had one multiaberrant cell each (we referred cells having more than 7 aberrations to multiaberrant).

Age dependency of chromosomal aberrations:

Age dependency of chromosomal aberrations frequency in blood lymphocytes was analyzed by the method of the Spearman ranks correlation coefficients. A strong age dependency was observed in the group of Yahotyn district: the Spearman ranks correlation coefficient was 0.71 ($p < 0.0005$), while it was

Table 3. Frequency of aberrant cells and chromosomal aberrations per 100 lymphocytes from ChNPP Exclusion Zone and Yahotyn district residents.
(individual range; mean \pm SD).

Group	Number of persons	Number of analyzed cells	Aberrant cells	Chromosome aberrations	Multiaberrant cells
ChNPP Exclusion Zone	33	11789	1.92 – 10.20 5.02 ± 1.95	2.24 – 10.80 5.32 ± 2.10	0.017 ± 0.066
Yahotyn district, Kiev region	31	12273	1.82 – 5.50 3.20 ± 0.84	1.82 – 6.00 3.51 ± 0.97	0.009 ± 0.25

Table 4. Frequency of various types of chromosomal aberrations per 100 cells in the Exclusion Zone self-settlers and the residents in Yahotyn district.

(individual range, $M \pm SEM$)

Group	Chromatid type			Chromosome type						
	breaks	exchanges	total	fragments	Interstitial deletions	dicentric + centric rings			abnormal monocentrics	total
						with fragment	without fragment	total		
ChNPP Exclusion Zone	0.6-5.6	0-1.0	1.0-6.6	0.3-4.9	0-0.5	0-1.0	0- 0.9	0-1.3	0 - 1.4	0.3-5.6
	3.01 ± 0.24	0.13 ± 0.04	3.14 ± 0.24	1.59 ± 0.20	0.02 ± 0.02	0.22 ± 0.05	0.10 ± 0.03	0.33 ± 0.06	0.23 ± 0.05	2.16 ± 0.24
Yahotyn district, Kyiv region	1.0- 4.0	0 - 3.0	1.0-4.0	0 - 2.2	0 - 0.5	0 - 0.5	0 - 0.25	0 - 0.5	0 - 0.8	0.3- 2.5
	2.31 ± 0.12	0.02 ± 0.01	2.33 ± 0.12	0.89 ± 0.12	0.04 ± 0.02	0.08 ± 0.03	0.05 ± 0.02	0.13 ± 0.03	0.12 ± 0.03	1.18 ± 0.13

-0.23 ($p > 0.05$) for the Zone group, i.e. in the latter group even some tendency to an inverse relationship with age is observed. It might be caused by the influence of additional factors in ChNPP Exclusion Zone, in particular, by the influence of radiation factor and perhaps by lower sensitivity of the elderly people (60+) to it. The similar results were obtained in our previous studies in which micronucleus test was utilized [2].

Ratio of chromosomal aberration types:

Table 4 shows the results of the analysis of frequency of various types of chromosomal aberrations in peripheral blood lymphocytes. Correlation between chromatid type and chromosome type aberrations in both groups corresponds to the ratio reported in the literature for spontaneous mutagenesis (2:1 – 1.5:1) [8]. The proportion of chromosome type aberrations in self-settlers' lymphocytes does not significantly differ from that of the control group; $39.2 \pm 2.8\%$ and $33.6 \pm 2.9\%$, respectively ($t=1.4$, $p=0.16$).

The induction of chromosome type aberrations is known to be characteristic for radiation exposure. Their mean group frequency in lymphocytes of the self-settlers was increased 1.8-fold compared with that of the Yahotyn residents, but at the same time there was a 1.3- fold increase in the frequency of chromatid type aberrations.

Chromosome type aberrations:

Exchange rearrangements are the most specific markers of radiation exposure. Unstable chromosome exchanges (*dic.* and *c.r.*) were detected in 60 % of the Zone self-settlers and in 45 % of the Yahotyn district inhabitants. In the Zone self-settlers' cells unstable exchanges occurred on the average 2.5 times more often than in the control group of Yahotyn district. In both groups the majority of unstable exchanges were accompanied by fragments. Routine staining of stable chromosome exchanges (abnormal monocentrics) also revealed a significant increase of mean group frequency in the Zone self-settlers (1.9-fold) with one third of the examined self-settlers and 16 % of Yahotyn district residents simultaneously revealing both stable, and unstable aberrations.

Reported spontaneous levels of unstable chromosome exchanges vary within the range of 0.03 % and 0.3 % [7, 10-12]. According to [11,13] the mean population frequency of the total *dic.* and *c.r.* is taken as 0.13 % – 0.16 %. Up to 1986 these damages were registered in the rural population of Ukraine with the frequency of 0.05 per 100 metaphases [9]. In our research we have revealed *dic.* and *c.r.* in the control area residents with the frequency of $0.13 \pm 0.03\%$, i.e. 2.6 times exceeding the pre-Chernobyl accident level for agricultural regions of Ukraine, but comparable with the mean population one.

The frequency of paired fragments per 100 metaphases was 1.59 ± 0.20 in lymphocytes of the Zone self-settlers versus 0.89 ± 0.12 in lymphocytes of the control group, while the mean pre-Chernobyl accident

level for the rural population of Ukraine was 0.47 [9]. Reported spontaneous levels of paired fragments are 0.25 – 0.65 per 100 cells [7, 10, 14]. It should be noted that in our research the increase of frequency of paired fragments in the Zone self-settlers is caused to a great extent by the excess of the number of isochromatid deletions. In addition in the course of analysis attention was paid to the fact that in cells of the Zone self-settlers some paired fragments were shown to be much longer than those usually observed.

Chromatid type aberrations:

As seen in Table 4, a significant increase of chromatid type aberrations per 100 metaphases of 3.14 ± 0.24 was registered in the Zone self-settlers compared with the value of 2.33 ± 0.12 in Yahotyn district residents. The pre-accident level for the rural population and the currently reported spontaneous levels of this indices were 1.05 [9] and 0.6 – 1.5 [7, 10, 14], respectively.

Thus, in the conditions of chronic irradiation the frequency both of chromosome type (at the account of single- and two-hit damages) and chromatid type aberrations increased in lymphocytes of the Zone self-settlers. The elevated frequency of single-hit acentrics in the presence of two-hit *dic* and *c.r.* is characteristic for continuous exposure to low dose rates of low-LET radiation [15]. Increase of the acentrics frequency was revealed in cells of persons having been exposed to occupational irradiation for 20 years [10].

It is difficult to interpret the causes of the increase of chromatid type aberrations, which is characteristic for non-radiation mutagenesis, in the Zone self-settlers. Probably, the influence of chemical mutagenes in places of the Zone self-settlers' residence is not worse than in the Yahotyn district villages. Since the time of the accident no pesticides or other fertilizers have been utilized in the Exclusion Zone, while traces of the pre-accident soil contamination are still found. As for the salts of heavy metals we determined the elevated content of zinc and cadmium (in comparison with standard index) in crops grown in the self-settlers' homesteads. The levels of air contamination in the villages by nitrogen and carbon oxides, ozone and heavy metals aerosols do not exceed maximum allowable concentration [16]. It is unlikely that the self-settlers use more medications in comparison with the Yahotyn district residents.

The following assumptions were made in the literature concerning the increase of chromatid type damages due to prolonged irradiation: a) reparation of chromosome damages in conditions of low dose rate irradiation results in partial transition of chromosome type aberrations to the class of chromatid type aberrations [17]; b) the low doses of radiation cause instability of the chromosome system, which increases sensitivity to other forms of mutagenes, such as viruses, chemical factors [18]. Data are available, according to which radionuclides in low doses affect cells more likely as chemical mutagenes, toxins than

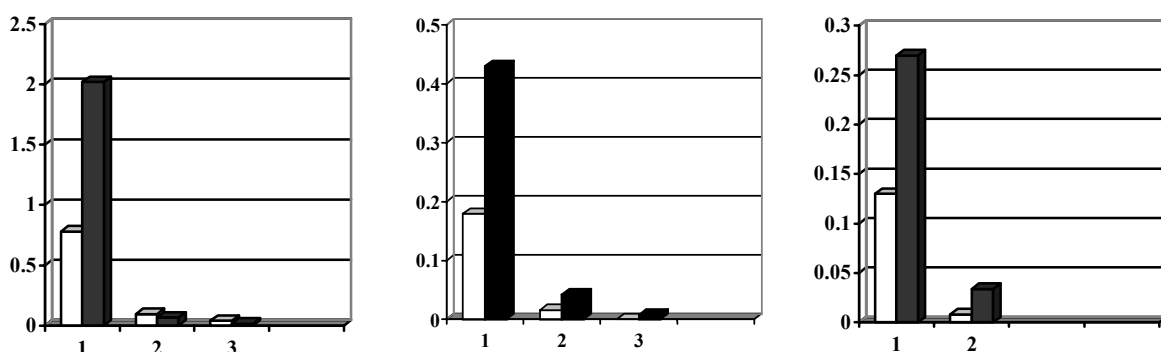

Fig. 2. Distribution of aberrant cells by the number of aberrations per cell in lymphocytes of the groups of ChNPP Exclusion Zone self-settlers (■) and the residents of Yahotyn district (□). % of the total number of examined cells.

- Left: total chromosome type aberrations
- Center: total chromosome type exchanges
- Right: unstable chromosome type exchanges

as radiation sources [19].

Distribution of aberrations in cells:

The important information for finding out the type, dose and uniformity of mutagenic exposure is the distribution of aberrations in cells. In both groups of the Zone self-settlers and the Yahotyn district residents we have found persons having cells with two and three chromosome type aberrations. Some persons had even two or three such cells (two self-settlers and four persons from Yahotyn district).

In such cells of the Yahotyn district residents aberrations are represented mainly by acentrics, which might be caused by the past viral infection [20] without clinical manifestations. Among the Zone self-settlers' cells with several chromosome type aberrations, cells prevail with 2-3 chromosome exchanges. Six self-settlers had such cells, and in five of them cells with 2 unstable exchanges were revealed, which is characteristic for exposure to radiation factor. One cell with two unstable exchanges with accompanying fragments was also found in one of Yahotyn district residents (27 years old), which probably testifies to the fact of some unaccounted irradiation in the region considered "radiation clean".

The comparison of the distributions of aberrant cells by the number of aberrations per cell is shown in Fig.2 for all chromosome type aberrations, all chromosome type exchanges and unstable chromosome type exchanges. A significant inter-group differences was revealed by χ^2 criterion ($\chi^2 > \chi^2_{0.01}$) between the Yahotyn district residents and the Zone self-settlers.

Cytogenetic examination in 2001

Time trend of chromosome aberration:

In order to investigate the dynamics of cytogenetic effects in the Zone self-settlers, 20 people from 33 already examined in 1998-99 were repeatedly analyzed in 2001. As it is seen in Table 5 this analysis has not revealed any changes in the mean group frequency not only of quantitative aberrations (metaphases with 47 chromosomes and tetraploids) but also of the total qualitative chromosome damages; the frequencies of aberrant cells and the number of aberrations per aberrant cell.

Table 5. Dynamics of cytogenetic effects in the peripheral blood lymphocytes of the ChNPP Exclusion Zone residents. (Number of examined persons - 20)

Year of examination	Number of analyzed cells	Frequency per 100 cells (individual range, M±SEM)					Number of aberrations per aberrant cell	Number of persons with "rogue" cells
		Metaphases with 47 chromosome	Tetraploids	Aberrant cells	"Rogue" cells	Chromosome aberrations		
1998-99	6978	0.73±0.14	0.48±0.10	1.9-10.2 5.44±0.52	0.14	2.2-10.8 5.79±0.55	1.06	7
2001	7923	0.75±0.10	0.39±0.07	2.2-9.5 4.99±0.41	0.09	2.2-10.4 5.41±0.49	1.08	4

Table 6. Dynamics of frequency of different type chromosomal aberrations in the blood lymphocytes of the ChNPP Exclusion Zone residents. (Number of examined persons - 20)

Year of examination	Frequency per 100 cells (individual range, M±SEM)									
	Chromatid type			Chromosome type						
	breaks	ex-changes	total	frag-ments	inerstitial deletions	dicentrics + centric rings			abnor-mal mono-centrics	total
						with fragment	without fragment	total		
1998-1999	1.0-5.6 3.0 ±0.33	0-1.0 0.16 ±0.07	1.0-6.6 3.17 ±0.33	0.3-4.9 1.77 ±0.30	0-0.5 0.025 ±0.025	0-0.9 0.29 ±0.081	0-0.5 0.10 ±0.04	0-1.3 0.39 ±0.09	0-1.4 0.32 ±0.08	0.3-5.9 2.58 ±0.35
2001	1.2-8.1 3.53 ±0.40	0-0.9 0.29 ±0.07	1.2-9.0 3.82 ±0.45	0-2.0 0.79* ±0.14	0-0.4 0.07 ±0.03	0-0.8 0.27 ±0.06	0-1.0 0.18 ±0.06	0-1.4 0.45 ±0.09	0-0.9 0.25 ±0.06	0.2-2.8 1.63* ±0.16

* $P < 0.05$

Studying the dynamics of different types of chromosome damage showed a significant decrease in the mean group frequency of chromosome type aberrations at the expense of a decrease in the yield of fragments, i. e. single-hit lesions. No alteration was found in the mean group frequencies of two-hit chromosome exchanges induction (Table 6).

“Rogue” cells:

We also analyzed the dynamics of “rogue” cell incidence, using the conventional definition of “rogue” cell proposed by M. A. Pilinskaya [21]. It has been proposed to refer to the cell as “rogue”, when containing more than one lesion with at least one of them being chromosome type exchange aberration. Table 7 shows an aberration spectrum seen in “rogue” cells. “Rogue” cells of the Zone residents contained mostly 2-3 chromosome exchanges. Some self-settlers were indicated to have several “rogue” cells. There were also “rogue” cells similar to those described by Awa and Neel [22] that contain polacentrics and “double minutes”. It is important to note that two individuals (encoded #15 and #29) were shown to have “rogue” cells in 1998 as well as in 2001. Individuals encoded #1 and #2 belonged to the same family. One of them exhibited “rogue” cells in 1998 and the other in 2001. In the inhabitants of the control Yahotyn district “rogue” lymphocytes mostly contained one chromosome exchange per cell.

The mean frequency of “rogue” cell incidence among analyzed lymphocytes in the first and second examinations of groups involving 20 individuals were 0.14 and 0.09 per 100 cells, respectively (Table 6). The frequency of these cells among lymphocytes analyzed in 1998-99 from the whole group of self-settlers consisting of 33 individuals was 0.10 per 100 cells. Therefore, this value was generally similar to

Table 7. Aberration spectrum in “rogue” peripheral blood lymphocytes of Exclusion Zone self-settlers and residents of Yahotyn district, Kyiv region.

Group	^{238,239,240} Pu, ²⁴¹ Am, kBq/m ²	Coded No.	Year of examination	
			1998 – 1999 (n=33)	2001 (n=20)
ChNPP Exclusion Zone	1 - 2	1	<u>2(dic+ace);</u> tr, dic+ace	
		2		tr, del, ace; 2tr, cr, dic+ace, 2min; tric, dic+ace, min
	1 – 2	8	dic+ace, tr, del	
	1– 4	19*	dic, del	
	2 – 4	29	tr, 2(dic+ace)	tetrac, min, 2ace; 2tr in tetraploid;
		15	tr, ace	dic+ace, tr
		12	dic, del	
	2 – 10	6	2(dic+ace)	
		21	dic+ace, del	
	4 – 10	32		2dic, dic+ace
30*		2dic, del, 10ace; 2dic		
10 – 40	18	2(dic+ace)		
Yahotyn district, Kyiv region n=31	0.02 – 0.1	1y	dic+ace, 2ace	
		11y	dic+ace, del	
		12y	dic, ace	
		18y	dic+ace, ace	
		20y	cr+ace, dic+ace	
		26y	dic, 2del	
		27y	tr, ace	

* - individuals examined in 1998-99 only.

the values of both investigation periods for 22 self-settlers, and 1.5-fold higher than that for Yahotyn district residents' lymphocytes (0.06 per 100 cells).

Cells containing multiple chromosome exchanges had been also found in residents of Belarus and Russia [23, 24]. According to [21] no "rogue" cells had been found in course of the examination of rural population of Ukraine before the Chernobyl accident.

According to the reported data, cells with two unstable exchanges are observed in acute general irradiation starting from a dose of 100 cGy onward [25]. Effective whole body doses of irradiation for the self-settlers due to external and internal irradiation, reconstructed by us till the beginning of 1999, did not exceed 33 cSv and on red bone marrow - 63 cSv. Probably, emerging of cells with multiple chromosomal aberrations under low dose radiation exposure could be connected with the presence of hypersensitive lymphocyte subpopulation [26]. In the case of the Zone self-settlers we intend most probably to assume that the incidence in blood of extremely "rouge" cells is due to non-uniform internal irradiation owing to getting into the body of α - emitting transuranium elements. It is likely that $^{238,239,240}\text{Pu}$ and ^{241}Am get into the body first of all with aerosols and probably with vegetative nutrition products. ^{241}Am content is accumulating on the Zone territory following β -decay of ^{241}Pu . During the post-accident years its amount increased from 0.003 to 0.04 PBq [27]. At the period of our investigations the level of soil contamination by ^{241}Am in the Zone appeared to coincide with the contamination level by all Pu-isotopes. Taking this situation into account, researches connected with transuranium elements content, particularly ^{241}Am , as the most available of those in nutrition products of the Zone residents are very important.

CONCLUSION

The results of our examination of ChNPP Exclusion zone self-settlers testify to the destabilizing effect of continuous low dose rate irradiation on genetic structures of somatic cells in conditions of living in the areas contaminated with radionuclides and to the expediency of cytogenetic monitoring of the population. The data obtained from studying of cytogenetic effects dynamics show that 12-15 years after the accident the level of chromosome damages in ChNPP Exclusion Zone self-settlers' lymphocytes comes to a plateau. The comparison of the results of cytogenetic examination of Yahotyn district inhabitants with the reported data on spontaneous levels of chromosomal damage allows us to assume the activation of mutagenesis in this region.

REFERENCES

1. L.K.Bezdrobnaya, E.P.Romanova, I.P.Drozd, E.A.Fedyuk, G.N.Koval. Micronucleus Analysis of Peripheral Blood Lymphocytes in Professionals and Self-Settlers of the Exclusion Zone of the Chernobyl NPP. *Cytology and Genetics (Tsitologiya i Genetika)*, 1997, v.31, N1, pp.40-45.
2. O.P. Romanova, L.K. Bezdrobna, I.P. Drozd Bioindication of the suprabackground irradiation of residents of radionuclide contaminated areas by micronuclei test. *Ukrainian Journal of Radiology*. 2001, v.9, N1, pp. 63-68 (in Ukrainian).
3. Biological Dosimetry: Chromosomal aberration analysis for dose assessment. Technical Reports No 260, IAEA, Vienna, 1986.
4. V.U. Urbakh. Mathematical statistics for biologists and physicians. Moskow. 1963, P.323 (in Russian).
5. E.V. Gubler. Application of nonparametric statistical criteria in medical and biological research. Leningrad: "Medicina", 1973, P.141 (in Russian).
6. V.Yu. Nugis. Methodology of assessing the doses by chromosomal aberrations in peripheral blood lymphocytes in chronic radiation exposure. *Med.Radiology*, 1996, v.41, N3, pp. 63-67 (in Russian).
7. N.P.Bochkov, A.N.Chebotaev, L.D.Katosova, V.I. Platonova. Data base for quantitative characteristics of chromosomal aberrations frequency in human peripheral blood lymphocytes assay. *Genetic*, 2001, v.37, N4, pp. 549-557 (in Russian).
8. N.P. Bochkov, N.P. Kuleshov, V.S. Zurkov. Assay of spontaneous chromosomal aberration in human

- lymphocytes culture. *Tsitologiya*, 1972, N14, pp.1267-1273 (in Russian).
9. M.A. Pilinskaya, A.M. Shemetun, A.U. Bondar, S.S. Dybski. Cytogenetic effect in somatic cells of persons exposed to radiation due to Chernobyl NPP accident. *Vestnik Acad. of Med. Science*, 1991, N8, pp. 40-43 (in Russian).
 10. S. Balakrishnan, S. B. Rao. Cytogenetic analysis of peripheral blood lymphocytes of occupational workers exposed to low levels of ionising radiation. *Mutat. Res.* 1999, v.442, pp. 37-42.
 11. M.A. Bender, A. Awa, A.L. Brooks, H.J. Evans, P.G. Groer, et al. Current status of cytogenetic procedures to detect and quantify previous exposures to radiation. *Mutat. Res.* 1988, v.196, pp.103-159.
 12. G. Stephan, S. Pressl. Chromosomal aberrations in peripheral lymphocytes from healthy subjects as detected in first cell division. *Mutat. Res.* 1999, v.446, pp.231-237.
 13. E.K. Pyatkin, A.E. Baranov. Biological indication of dose by chromosomal aberrations assay in peripheral blood. *Radiation biology AUIFSATI (Summaries on science and engineering)* 1980, N3 pp.103-179 (in Russian).
 14. N.P. Bochkov, N.A. Popova, L.D. Katosova, U.S. Yakovleva, et al. Unusually high level of chromosomal variability in human peripheral lymphocyte cultures. *Genetics* 1999, v.35, N6, pp.838-841 (in Russian).
 15. R.J. Purrot, D.C. Lloyd, G.W. Dolphin, E.J. Eltham, et al. The study of chromosome aberrations yield in human lymphocytes as indicator of radiation dose: III. A review of cases investigated: 1971-1972. *NRPB-RIO*, 1973.
 16. I.I. Karachev. Study of living conditions of temporary residents of ChNPP exclusion zone settlements. Report USGC Ministry of Health of Ukraine, contract #13/152H-99, Kyiv, 1999, P.33 (in Russian).
 17. V.A. Shevchenko, E.A. Akaeva, V.D. Arutunyan, L.N. Bashlykova, et al. Cytogenetic examination of population with a purpose of biological dosimetry as a result of accident on Chernobyl NPP. In: *The Reports of the First All-Union Scientific and Technical Meeting on Results of liquidation of Chernobyl NPP accident aftermath «Chernobyl'88»*, 1989, pp.225-243 (in Russian).
 18. I.E. Vorobtsova, M.V. Vorobyeva, A.N. Bogomazova, A.Yu. Pukkenen, T.B. Arkhangelskaya. Cytogenetic study of children living in St. Petersburg region, who have suffered from the Chernobyl accident. The rate of unstable chromosome aberrations in peripheral blood lymphocytes. *Radiation biology. Radioecology*, 1995, v.35, N5, pp. 630-635 (in Russian).
 19. S.C. Sheppard, J.E. Guthrie, D.H. Thibault. Germination of seeds from an irradiated forest: Implication for waste disposal. *Ecotoxicol. and Environ. Safety*. 1992, v.23, N3, pp. 320-327.
 20. N.P. Bochkov, A.N. Chebotarev. *Human heredity and environmental mutagens*. Moskow: Medicina, 1989, P.272 (in Russian).
 21. M.A. Pilinskaya, A.M. Shemetun, S.S. Dybski, D.V. Redko, I.A. Znaevskaya. Identify of the multiaberrant lymphocytes at cytogenetic examination of different groups of persons who have contact with mutagenic factors. *Tsitologiya and Genetika*. 1994, v.28, N1, pp.27-32 (in Russian).
 22. A.A. Awa, J.V. Neel. Cytogenetic "rogue" cells: what is their frequency, origin and evolutionary significance. *Proc. Nat. Acad. USA*. 1986, N 83, pp.1021-1025.
 23. E.V. Domracheva, I. Verskhaeva, S.A. Kuznetsov, et al. Chromosome aberrations in residents of Homel and Homel district: a result of residence on radionuclide contaminated territories. *Therapeutic archive*. 1992, N7, pp.29-33, (in Russian).
 24. E.V. Domracheva, S.A. Kuznetsov, N.E. Shklovski-Kordy, et al. Cells with multiple aberrations revealed in residents of Chornobyl region. *Gematologiya and transfusiologiya*. 1991, N 11, pp.36-37 (in Russian).
 25. N.P. Bochkov. Analysis of the aberrant cell types - an obligatory component of biological indication of irradiation. *Med. Radiologiya* 1993, v.38, N2, pp.32-35 (in Russian).
 26. D.C. Lloyd, A.A. Edwards, A. Leonard, et al. Frequencies of chromosomal aberrations induced in human blood lymphocytes by low doses of X-rays. *Int. J. Radiat. Biol.* 1988, v.53, N1, pp.49-53.
 27. E.B. Lyovshin, V.A. Ageev, O.V. Gaydar, et al. Transuranium elements in exclusion zone. *Bulletin of ecology state of Exclusion zone*. 1999, N13, pp.57-58 (in Russian).

Cytogenetic Effects of Radiation on Agricultural Plants Observed in the Chernobyl region during the First Years after the Accident

Stanislav A. GERASKIN, Vladimir G. DIKAREV, Yevgenia Ya. ZYABLITSKAYA,
Alla A. OUDALOVA, Yevgeniy V. SPIRIN

*Russian Institute of Agricultural Radiology and Agroecology,
249020, Obninsk, Kaluga Region, Russia: riar@obninsk.org*

Abstract

The cytogenetic consequences of radioactive contamination by the fallout after the accident at the Chernobyl NPP in 1986 to agricultural crops have been studied. In the acute period after the accident (1986), when the absorbed dose was mostly provided with external β - and γ -radiation, the radiation injury of agricultural crops resembled the effect produced by acute γ -radiation at comparable doses as basic cytogenetic tests testify. The yield of cytogenetic damage in leaf meristem of plants grown in the 10-km zone of the ChNPP in 1987-1989 (the period of chronic, lower level radiation exposure) was shown to be enhanced and dependent on the level of radioactive contamination. The rate of decline with time in cytogenetic damage induced by chronic exposure lagged considerably behind that of the radiation exposure. Analysis of genetic variability in three sequential generations of rye and wheat revealed increased cytogenetic damage in plants exposed to chronic radiation during the 2nd and the 3rd years.

Introduction

The accident at the Chernobyl NPP in 1986 is unique in both the extent of radioactive contamination and the values of the doses absorbed by living organisms. An estimation of total release of fission products (without noble gases) amounted to $1.85 \cdot 10^{18}$ Bq [1]. The areas most heavily exposed to radiation were natural and agricultural ecosystems within the 30-km ChNPP zone, with radioactive contamination reaching several thousands of MBq m⁻² in 1986. The Chernobyl accident happened in late April - early May, i.e., the period of accelerated growth and formation of reproductive organs of plants, when their radiosensitivity is high. The maximum impact to living organisms was caused during 10-20 days after the accident when short-lived isotopes made a considerable contribution to the absorbed dose. During the summer and early autumn of 1986 the dose rate on the soil surface dropped to 20-25% of the initial value [2]. Since the autumn of 1986, the radiological situation in the exclusion zone has been stabilised; the acute irradiation at relatively high dose rates was replaced with low dose rate chronic exposure that persists up to the present time.

Cytogenetic and biological effects have been studied in rye seeds collected from agricultural fields in the 30-km ChNPP zone in 1986, and on intercalary leaf meristem of winter and spring crops grown on experimental plots in the 10-km ChNPP zone in 1987-1989.

Description of experimental plots

Seeds of winter rye of the "Belta" cultivar (from 50-100 main ears per plot) were collected on 4-6 August, 1986 from 5 m² plots in five fields with different dose rates of γ -radiation in the 30-km ChNPP zone. Seeds from a granary were used as control. The radiological characteristics of the experimental plots at the time of seed sampling are presented in Table 1.

The experimental plots in 1987-1989 were chosen with regard to the level of radioactive contamination of the territory, landscape and economic use of the land prior to the accident. Two pairs of

Table 1. Radiological characteristics of farm fields in the 30-km zone of the ChNPP.

Plot	σ , (MBq.m ⁻²)	D _γ , (Gy)	D _β , (Gy)	D _{β+γ} , (Gy)
1. Kozhushki	19.6	0.18	1.15	1.33
2. Chamkov	58.1	0.33	2.80	3.13
3. Radin	61.1	0.58	3.40	3.98
4. Borzhshevka	129.5	1.20	6.50	7.70
5. Krasno	263.8	1.15	10.80	11.95

σ - total contamination density within 0-2 cm soil layer in August, 1986;

D_γ, D_β, D_{β+γ} - doses absorbed over the vegetative period by plant critical organs.

Table 2. Radionuclide composition and contamination density on experimental plots in the 10-km zone of the ChNPP (May 15, 1988).

Plot	Location	Type of soil	Contamination density, (MBq.m ⁻²)	Radionuclide composition, (%)				
				⁹⁰ Sr	¹⁰⁶ Ru	¹³⁴ Cs	¹³⁷ Cs	¹⁴⁴ Ce
1	Meadow behind Chistogalovka	soddy podzolic	11.7	11.2	15.3	4.3	18.1	51.1
2	Meadow before Chistogalovka	sandy loam	106.0	8.1	13.7	5.3	25.0	47.9
3	ABZ	peaty humus gley	65.8	2.8	20.0	4.6	20.4	52.2
4	Red forest	peaty humus gley	454.0	9.1	13.1	4.6	20.7	52.5

plots were chosen to obtain comparative results. The plots in each pair were similar in soil type, but had diverse levels of radioactive contamination (Table 2). All four plots are situated 5-10 km west of the ChNPP along the Yanov-Chistogalovka road. The soils are typical for the Ukrainian Polesie, i.e. soddy podzolic, sandy and sandy loam, with different degrees of cultivation, a low availability of mineral nutrition and low sorption capacity for the most radionuclides. The arable layer has a low content of organic matter, available phosphorus and potassium, and a relatively high content of readily hydrolysable nitrogen. The soil solution reaction is acid (pH=4.4 - 4.6) and sub-acid (pH=5.1 - 5.3). A detailed description of plots was given in [3]. Winter (rye and wheat) and spring (barley and oats) crops were sowed using appropriate agricultural practices. The area of the experimental plots varied from 5 to 25 m². Samples of the leaf intercalary meristem of spring barley and oats were collected when the rudimentary ears reached 5 cm above the ground (at 2-3 weeks after sowing). Samples of winter rye and wheat were picked 2 times per year, at 3-4 weeks after sowing in the autumn and on the 10th day after the commencement of growth in spring

Materials and methods

Experiment in 1986

Seeds of winter rye collected in 1986 were allowed to germinate at 25-26° C. 15-30 seedlings were fixed at 16, 18, 20, 22, 24, 40, 48 and 72 hours of growth. Temporary squash slides prepared from the root apical meristem of each seedling were stained with aceto-orcein. In each slide, the mitotic index was calculated per 1000 cells, all ana-telophase cells were scored for aberrations; the aberration spectrum consisted of chromatid (single) and chromosome (double) bridges and fragments, as well as lagging chromosomes. 20-40 seedlings were simultaneously measured to determine the main root length. The laboratory germination rate was studied using the accelerated method of Stepanov [4].

To estimate the total density of radioactive contamination and the doses absorbed by the plants, soil was sampled by "envelop" method (taking samples from four corners and from the centre of the plot and calculating the density as an average) on each of the five fields. The samples were analysed by γ -

spectrometry of the upper layer (0-2 cm) samples.

The estimation of the total dose for rye over the vegetative period in 1986 was based on the radionuclide composition of the fallout and models describing both the growth of cereal plants and the radionuclide migration in the soil profile. The absorbed dose of γ -radiation was calculated by summing up the contributions from all lines of the spectrum obtained by γ -spectrometry on May 8, 1986 at assumption of a uniform radionuclide distribution in the soil to a depth of 1 cm. In calculations of the absorbed dose from β -radiation, the total β -radioactivity was assumed to consist of two parts. The first one is distributed over the soil surface and decreases from 100 % to 0 during the whole vegetative period (100 days) and the second one is distributed uniformly within the surface 1 cm soil layer and increases from 0 to 100 %. The absorbed doses of β -radiation were calculated by integrating the point source dose attenuation function for each radionuclide as described by [5]. The absorption coefficient for tissues covering the critical organ was set equal to 0.5.

Experiments in 1987-1989

Samples of the leaf intercalary meristem collected from the crop plants in 1987-1989 were fixed in acetic alcohol (1:3), stained with aceto-orcein and examined for aberrations (bridges and fragments) in ana-telophase. Five replicates were made for each plot at every sampling. Then, 100 ana-telophases were scored for each replicate.

An estimate of doses absorbed by the leaf meristem of plants in 1987-1989 was based on the data on soil radioactivity level and composition of the radionuclide contamination. Models of the infinite uniform source and of the infinite 20-cm thick layer source were used to calculate doses from β - and γ -radiation, respectively. The duration of the radiation exposure before sampling leaf meristem in spring crops was taken to be 30 days; in winter crops - 35 days for the autumn sampling and 210 days for sampling in the spring of the next year. When doses absorbed by a growing point over the whole vegetative period were estimated, the time between appearance of the growth point above the soil surface and harvesting was assumed to be equal to 100 days. γ -Radiation made the main contribution to absorbed dose during this time.

The radiometric analysis showed that the contamination density of soil varied considerably even within the area of one plot although the relative contents of radionuclides in all samples were similar (Table 2). Therefore, an average value for the density of radioactive contamination was calculated from the data on the absorbed dose rate in air. The ratio between the contamination density of soil and the absorbed dose rate in air was determined experimentally at the plot, which had the least variability in the measured levels of radioactive contamination. The dose rate of γ -radiation in air was measured with lithium fluoride thermoluminescent dosimeters (TLD-100). Prior to measurements, the dosimeters were calibrated in a γ -radiation field of ^{137}Cs against the reference dosimeter 27012. To record γ -radiation only, the detectors were exposed in a 3 mm thick protective aluminium capsule. Changes in the dose rate of γ -rays with time were registered by DRG-01T dosimeter.

Optimum sample sizes needed for the estimation of examined values with a certain relative probable error at a given confidence level were determined by a method of statistical analysis of empirical distribution [6]. Student's test and confidence intervals were used to confirm statistical significance.

Results and Discussion

Winter rye, 1986

The experimental plots differed in the radioactive contamination of the soil surface layer and the dose absorbed by plant critical organs over the vegetative period by almost an order of magnitude (Table 1). According to the classification of zones of chronic radiation exposure of natural populations [7], the

Table 3. Aberrant cells in seedlings root meristems of winter rye seeds collected in the 30 km ChNPP zone (mean \pm SE).

Plot	Dose, (Gy)	Cells in ana-telophase	Aberrant cells	Aberrant cell frequency, (%)
-	Control	952	40	4.20 \pm 0.65
1	1.3	749	33	4.41 \pm 0.75
2	3.1	1402	101	7.20 \pm 0.69*
3	4.0	787	51	6.48 \pm 0.88
4	7.7	447	49	10.96 \pm 1.48**
5	12.0	668	95	14.22 \pm 1.35***

Significance of variation from control: * - $p < 5\%$, ** - $p < 1\%$, *** $p < 0.1\%$;

Table 4. Damage distribution and severity of damage to aberrant cells in winter rye.

Plot	Dose, (Gy)	AC	AC _c	Number of cells with the following quantity of aberrations					Severity of damage, (aberrations per damaged cell)	MD, (%)
				1	2	3	4	5		
-	Control	40	4	27	5	4	0	0	1.36 \pm 0.11	32.5
1	1.3	33	3	29	1	0	0	0	1.03 \pm 0.10	12.1
2	3.1	101	9	64	23	3	1	1	1.39 \pm 0.07	36.6
3	4.0	51	5	31	11	2	1	1	1.48 \pm 0.19	39.2
4	7.7	49	5	29	9	4	2	0	1.52 \pm 0.13	40.8
5	12.0	95	11	43	30	5	4	2	1.71 \pm 0.12	54.7

Cells with complex indistinguishable damage were excluded from calculation of severity of damage.

AC - total number of aberrant cells; AC_c - number of cells with complex damage; MD is a percent of cells with multiple and complex damages.

radiation-induced biological effects should dominate over those of other ecological factors at least on the two experimental plots with the highest levels of radioactive contamination. The contribution of β -radiation to the total absorbed dose is different for each plot, but in all cases it is 6-9 times higher than that of γ -radiation.

Table 3 presents the results of the cytogenetic analysis of seedlings root meristems of winter rye seeds collected on contaminated plots. Even a dose of 3.1 Gy absorbed by plants results in a significant increase in the yield of aberrant cells. It is pertinent to note that significant increase in the aberrant cells rate in the root meristem of other agricultural crops was observed after exposure of seeds to γ -rays at comparable doses [8, 9].

Data on the damage distribution per cell are given in Table 4. To calculate the severity of damage in the aberrant cells, we used information on biological variability of this value among seedlings. The analysis of changes in the severity versus the absorbed dose showed a significant growth in the degree of cell damage along with radiation exposure. Overall, the severity of damage at chronic irradiation is within the limits registered in our previous experiments on exposure of seeds of agricultural crops to γ -rays at comparable doses [8,9].

Analysis of data on specific types of structural aberrations and their partial frequency (Table 5) has shown that there are no essential changes in the aberration spectrum with dose. The prevalent types of cytogenetic disturbance in the variety of rye examined, both for control and at chronic irradiation, are chromatid mutations followed by lagging chromosomes and chromosome aberrations. The low relative contribution of chromosome aberrations is supposed to be a specific feature of the biological material used. In our previous investigations [8,9] of structural mutations induction in root meristems of wheat and barley seeds exposed to ionising radiation, the contribution of chromosome aberrations was also small.

Table 5. Structural mutations spectrum in winter rye exposed to radioactive contamination.

Plot	Dose, (Gy)	TA	Different type aberrations									
			Number					%				
			g	f'	m'	f''	m''	g	f'	m'	f''	m''
-	control	49	5	27	13	1	3	10.2	55.1	26.5	2.0	6.1
1	1.3	31	4	18	9	0	0	12.9	58.1	29.0	0	0
2	3.1	128	9	63	41	5	10	7.1	49.2	32.0	3.9	7.8
3	4.0	68	13	32	18	0	5	19.1	47.0	26.5	0	7.4
4	7.7	67	7	34	23	0	3	10.4	50.8	34.3	0	4.5
5	12.0	144	19	59	55	4	7	13.2	41.0	38.2	2.8	4.9

Cells with complex indistinguishable damage are excluded.

TA - total number of aberrations; g - lagging chromosomes (genome mutations); f', m' - chromatid (single) fragments and bridges with associated fragments; f'', m'' - chromosome (double) fragments and bridges with associated fragments.

Table 6. Some viability indicators of seeds collected in the 30 km ChNPP zone (mean ± SE).

Plot	Dose, (Gy)	Mitotic index, (%)			Main root length, (mm)			Germination, (%)
		16-24 h	40-48 h	72 h	16-24 h	40-48 h	72 h	
-	Control	1.69 ± 0.25	3.83 ± 0.26	3.09 ± 0.17	1.96 ± 0.19	22.95 ± 1.19	34.21 ± 3.42	62.0 ± 2.4
1	1.3	1.16 ± 0.23	2.64 ± 0.23*	3.24 ± 0.79	2.22 ± 0.20	12.85 ± 1.13	34.46 ± 2.17	87.5 ± 1.7*
2	3.1	1.73 ± 0.22	2.29 ± 0.17*	3.95 ± 0.35	2.27 ± 0.17	17.75 ± 0.97	37.97 ± 2.93	74.5 ± 2.2*
3	4.0	1.25 ± 0.18	2.54 ± 0.18*	3.79 ± 0.26	1.83 ± 0.14	13.35 ± 0.93	45.29 ± 3.33	88.8 ± 1.6*
4	7.7	0.83 ± 0.17	2.75 ± 0.16*	3.99 ± 0.25	1.64 ± 0.11	12.70 ± 0.77	36.06 ± 3.21	70.8 ± 2.3
5	12.0	1.11 ± 0.20	2.61 ± 0.27*	2.98 ± 0.32	1.93 ± 0.24	13.80 ± 0.73	25.48 ± 3.49	31.2 ± 2.3*

Mean values over the first (16-24 h) and the second (40-48 h) mitosis are presented.

Significance: * - p<5%.

Such an unusual result may be due to the possible induction at G₁ stage, of long-lived potential damage that is later realised as genuine mutations at S and G₂ stages. Dubinin & Nemtsova [10] have obtained similar results analysing aberration spectrum in root meristems of irradiated seeds of agricultural plants.

Table 6 presents data on some viability indicators of seeds collected on the plots in the 30 km ChNPP zone. The mitotic indices determined at 8 time points (16-72 hours after germination) show that there is an insignificant tendency for mitotic activity to decline with the increase in the dose absorbed. A significant radiation depression of mitotic activity was observed only in 40-48-hours seedlings. However, at this time point, the mitotic indices don't correlate with dose. Seed germinating power shows statistically significant stimulation effects at doses of 1.3-4.0 Gy, and considerable, statistically significant inhibition at the dose of 12 Gy. Attention should be paid to the fact that some of the morphological indices illustrating the viability of germs at early stages of ontogenesis depend on dose. It should also be noted that morphological stimulation (Table 6) was accompanied by high and significant increment of cytogenetic disturbances. This result appears a good illustration of the ambiguous nature of "stimulation" and indicates that the term should not be considered as a synonym for "benefit" or even harmlessness of exposure, because this outcome, assumed to be positive in terms of economic efficacy, may simply be a small part of a wider biological phenomenon that is negative overall.

Thus, in the first acute period after the Chernobyl accident, when the absorbed dose was primarily formed by external β- and γ-radiation, the radiation injury to agricultural crops, according to the basic cytogenetic tests, resembled the effect produced by acute γ-irradiation at comparable doses.

Table 7. Aberrant cell frequency in the leaf meristem of spring crops grown on experimental plots in the 10-km ChNPP zone.

Plot	Dose, (cGy)	Barley		Oats	
		Number of AC	Frequency of AC, (%)	Number of AC	Frequency of AC, (%)
1	2.05	142	28.4 ± 2.0	203	40.6 ± 2.2
3	12.09	181	36.2 ± 2.1	161	32.2 ± 2.1
2	17.90	156	31.2 ± 2.2	274	54.8 ± 2.2*
4	78.46	261	52.2 ± 2.2*	271	54.2 ± 2.2*

AC is aberrant cells. Significance of variation from plot 1: * - p<5%.

Spring barley and oats, 1988

Experiments with spring crops (barley and oats) were only carried out in 1988. Table 7 gives the data on the frequency of aberrant cells in the leaf meristem of barley and oats grown on plots with a nearly 40-fold difference in radioactive contamination density. The yield of aberrant cells trends to rise with the absorbed dose, indicating the radiation-induced nature of the observed changes. The levels of cytogenetical damage in oats generally exceed those in barley at the same absorbed doses, which is the reverse of the relationship for values of LD₅₀ reported by [11].

In this study there are unexpectedly high levels of cytogenetic disturbances in comparison with our previous experiments on acute [12,13] and chronic γ -irradiation of barley plants [14]. According to [12-14], the spontaneous level of aberrant cells in the leaf meristem of barley was 10-14%. In the present study, the yield of cytogenetic disturbances was 2-3 times higher than the spontaneous occurrence expected from our works on acute γ -irradiation of barley plants even at plots with the lowest levels of radioactive contamination. Such an apparent discrepancy between the level of genetic effects expected from the dosimetric data and the level observed in the experiment has also been reported by other authors who had carried out investigations in the 30-km Chernobyl zone [15,16].

Winter wheat and rye, 1987-1989

An estimation of consequences of radioactive contamination should take into consideration that winter crops are subjected to radiation for a longer time and their leaf meristem lies within the upper, most densely contaminated soil layer during the winter dormancy period. Experiments with winter crops (wheat and rye) were carried out from the autumn of 1987 till the autumn of 1989. Therefore, from the data available, conclusions can be drawn not only about dose dependence of cytogenetic damage rate but also about how the plant response to radiation changed as the absorbed dose decreased with time due to both radioactive decay and the migration of radionuclides in soil.

Frequencies of aberrant cells in the leaf meristem of winter rye and wheat grown on plots with diverse levels of radioactive contamination are given in Table 8. For winter wheat, there is a significant decrease in the yield of cytogenetic disturbances with time from the accident at all plots except plot 3. For winter rye, such a decrease is observed at plots 2 and 4. At the same time, the yields of the aberrant cells per dose unit rise with time in all autumn samplings (Table 8). This means that the rate of decline in the cytogenetic damage to plants lags behind that of radiation exposure. This phenomenon was also reported by [17].

The regression analysis for each year and for each sampling time has shown a general significant development in the frequency of aberrant cells with increase in the dose absorbed by plants, indicating thereby the role of radiation exposure in the observed alterations. However, no significant dose dependence was revealed: a) in the autumn of 1989, in rye (p<0.07), when the absorbed dose decreased by 2.6 times compared with 1987 and b) in the spring of 1988, in wheat (p<0.22) and rye (p<0.06), when doses absorbed by plants were maximal over the investigated period and one could expect an apparent dose-effect relationship. If we distinguish two sets of the data for peaty humus gley (plots 3 and 4) and for soddy podzolic sandy loam (plots 1 and 2) soils, there is the expected dose dependence, as seen in the case

Table 8. Aberrant cells frequency in leaf meristem cells of winter crops grown in the 10-km ChNPP zone.

Sampling time	Dose, (cGy)	Rye		Wheat	
		AC, %	AC per 1 cGy	AC, %	AC per 1 cGy
Plot 1 (soddy podzolic soil)					
Autumn 1987	3.88	19.0 ± 1.8	4.90 ± 0.97	32.4 ± 2.1	8.35 ± 1.24
Autumn 1988	1.99	21.4 ± 1.8	10.75 ± 1.39	23.0 ± 1.9 ^a	11.56 ± 1.43
Autumn 1989	1.03	20.2 ± 1.8	19.61 ± 1.78	18.0 ± 1.7 ^a	17.48 ± 1.70
Spring 1988	17.94	26.0 ± 2.0	1.45 ± 0.53	53.2 ± 2.2	2.97 ± 0.76
Spring 1989	10.26	20.4 ± 1.8	1.99 ± 0.62	23.2 ± 1.9 ^b	2.26 ± 0.66
Plot 3 (peaty humus gley soil)					
Autumn 1987	23.15	20.2 ± 1.8	0.87 ± 0.42	24.0 ± 1.9	1.04 ± 0.45
Autumn 1988	11.67	25.4 ± 1.9	2.18 ± 0.65	24.8 ± 1.9	2.13 ± 0.64
Autumn 1989	5.81	23.4 ± 1.9	4.03 ± 0.88 ^a	21.2 ± 1.8	3.65 ± 0.84 ^a
Spring 1988	106.50	32.8 ± 2.1	0.31 ± 0.25	34.6 ± 2.1	0.32 ± 0.25
Spring 1989	59.74	22.0 ± 1.9 ^b	0.37 ± 0.27	24.0 ± 1.9 ^b	0.40 ± 0.28
Plot 2 (sandy loam soil)					
Autumn 1987	33.50	32.4 ± 2.1	0.97 ± 0.44	33.4 ± 2.1	1.00 ± 0.44
Autumn 1988	17.48	24.2 ± 1.9 ^a	1.38 ± 0.52	25.6 ± 2.0	1.46 ± 0.54
Autumn 1989	9.36	20.6 ± 1.8 ^a	2.20 ± 0.66	20.6 ± 1.8 ^a	2.20 ± 0.66
Spring 1988	155.75	59.6 ± 2.2	0.38 ± 0.28	68.6 ± 2.1	0.44 ± 0.30
Spring 1989	90.63	24.6 ± 1.9 ^b	0.27 ± 0.23	24.6 ± 1.9 ^b	0.27 ± 0.23
Plot 4 (peaty humus gley soil)					
Autumn 1987	148.78	45.2 ± 2.2	0.30 ± 0.25	39.6 ± 2.2	0.27 ± 0.23
Autumn 1988	76.14	26.6 ± 2.0 ^a	0.35 ± 0.26	27.6 ± 2.0 ^a	0.36 ± 0.27
Autumn 1989	39.60	22.8 ± 1.9 ^a	0.58 ± 0.34	25.8 ± 2.0 ^a	0.65 ± 0.36
Spring 1988	687.20	47.4 ± 2.2	0.07 ± 0.12	42.8 ± 2.2	0.06 ± 0.11
Spring 1989	392.49	29.8 ± 2.0 ^b	0.08 ± 0.12	29.8 ± 2.0 ^b	0.08 ± 0.12

AC – frequency of aberrant cells;

^a and ^b – difference from the level of the autumn 1987 and the spring 1988, correspondingly, is significant, p<0.05.

of the spring crops. Attention is drawn to the abnormally low level of cytogenetic disturbances in wheat at plot 3 in the autumn of 1987 and spring of 1988, which differ significantly from that at plot 1 with the lowest level of radioactive contamination. The reason for this abnormal observation is not clear yet.

It is interesting that slopes of fitted linear dose curves in autumn are considerably higher than in spring of the following year for both cereals. So, the yield of aberrant cells in autumn has closer correlation with dose absorbed by plants than that in spring. Dose was accumulated over a prolonged time in spring samples, so cytogenetic damage probably depends not as much on radiation as on other factors.

Variability in the plant generations

Over the entire period of investigations (autumn of 1987 - autumn of 1989), a part of the seeds collected was planted again on the same plots, allowing study of genetic variability in three successive generations of winter rye and wheat. The doses absorbed by a growing point of plant over the whole vegetative periods from planting to harvesting of 1987-1988 and 1988-1989 were in the range of 18 - 717 cGy and 11 - 418 cGy, respectively. Each of these doses accumulated during vegetation is a sum of two values, i.e. the dose absorbed from planting in autumn to the time of spring sampling (Table 8) and a dose absorbed from spring sampling to seed harvesting. The last value is comparatively small because the most part of dose is delivered to plants with β -radiation while the growing point is under or near the soil surface prior to the spring sampling.

In rye, in the autumn of 1989, at plots 2 and 4 with the highest level of radioactive contamination, the

frequencies of aberrant cells in the leaf meristem in plants growing on contaminated sites in the second year (marked as the X₂ generation) and the third year (the X₃ generation) significantly exceed the values for those growing only in the first year (the X₁ generation) (Table 9).

In contrast to the results obtained by [18], the level of genetic variability in the X₃ generation in the present study does not decline and even somewhat increases (Figure 1), though there is no statistically significant difference between the yields of aberrant cells in the X₂ and X₃ generations. The results of our study correspond well with the data reported by [15] who observed a rise in mutation load in the *Arabidopsis thaliana* populations at all levels of radioactive contamination during the first 2-3 years after the accident. In wheat, this tendency is more pronounced. In the autumn of 1989, a significant increase in the frequencies of aberrant cells in the X₂ and X₃ generations, compared with X₁, was recorded at 3 out of 4 plots (Table 9). Differences between the numbers of aberrant cells in the X₂ and X₃ generations are small and statistically insignificant for both crops (Figure 1).

One of the possible explanations of the observed phenomenon is related to genome destabilisation in plants grown from seeds affected by radiation. Results from numerous experiments carried out with representatives of different kingdoms of the living world [17,19] indicate that chronic irradiation in regions affected as a result of the accident at the Chernobyl NPP can cause heritable destabilisation of genetic structures that appears, in particular, as an increased yield of cytogenetic disturbances and karyotypic variability in the offspring of irradiated organisms. From these viewpoints, the phenomenon observed in this study may be a reflection of the first stage in cytogenetic adaptation [20,21], that is,

Table 9. Aberrant cells frequency in leaf meristem of winter rye and winter wheat in 3 subsequent plant generations grown on the plots in the 10-km ChNPP zone (sampling time is autumn 1989).

Plot	D ₈₇₋₈₈ , (cGy)	D ₈₈₋₈₉ , (cGy)	D, (cGy)	Rye		Wheat	
				Number of aberrant cells	Aberrant cell frequency, (%)	Number of aberrant cells	Aberrant cell frequency, (%)
X ₁ -generation (first year of planting on contaminated plots)							
1			1.03	101	20.2 ± 1.8	90	18.0 ± 1.7
3			5.81	117	23.4 ± 1.9	106	21.2 ± 1.8
2			9.36	103	20.6 ± 1.8	103	20.6 ± 1.8
4			39.60	114	22.8 ± 1.9	129	25.8 ± 2.0
X ₂ -generation (second year of planting on contaminated plots)							
1		10.68	1.03	119	23.8 ± 1.9	130	26.0 ± 2.0*
3		63.54	5.81	144	28.8 ± 2.0	135	27.0 ± 2.0
2		95.93	9.36	155	31.0 ± 2.1*	146	29.2 ± 2.0*
4		417.49	39.60	165	33.0 ± 2.1*	170	34.0 ± 2.1*
X ₃ -generation (third year of planting on contaminated plots)							
1	18.45	10.68	1.03	136	27.2 ± 2.0	132	26.4 ± 2.0*
3	111.1	63.54	5.81	150	30.0 ± 2.0	157	31.4 ± 2.1*
2	162.05	95.93	9.36	179	35.8 ± 2.1*	150	30.0 ± 2.0*
4	717.2	417.49	39.60	163	32.6 ± 2.1*	167	33.4 ± 2.1

D – dose, accumulated from planting in autumn 1989 to the sampling time;

D₈₇₋₈₈, D₈₈₋₈₉ – doses, accumulated by parent plants during the whole vegetative period from planting up to harvesting in 1987-1988 and 1988-1989 years, respectively

X₁-generation – plants grown from intact seeds and accumulated dose D from planting in autumn 1989 to the sampling time;

X₂-generation – parent plants were sown in 1988, harvested in summer 1989 and planted again on the same plots in autumn 1989. Genetical effects are the result of both the ancestral dose D₈₈₋₈₉ and current exposure D;

X₃-generation - parent plants grew on the same plots in 1987-1988 and in 1988-1989 and accumulated doses D₈₇₋₈₈ and D₈₈₋₈₉, correspondingly. Seeds harvested in 1989 were sown again in autumn 1989 and plants of the X₃ generation got dose D.

Significance of variation from the level of cytogenetic disturbances in the X₁ generation: * - p<5%.

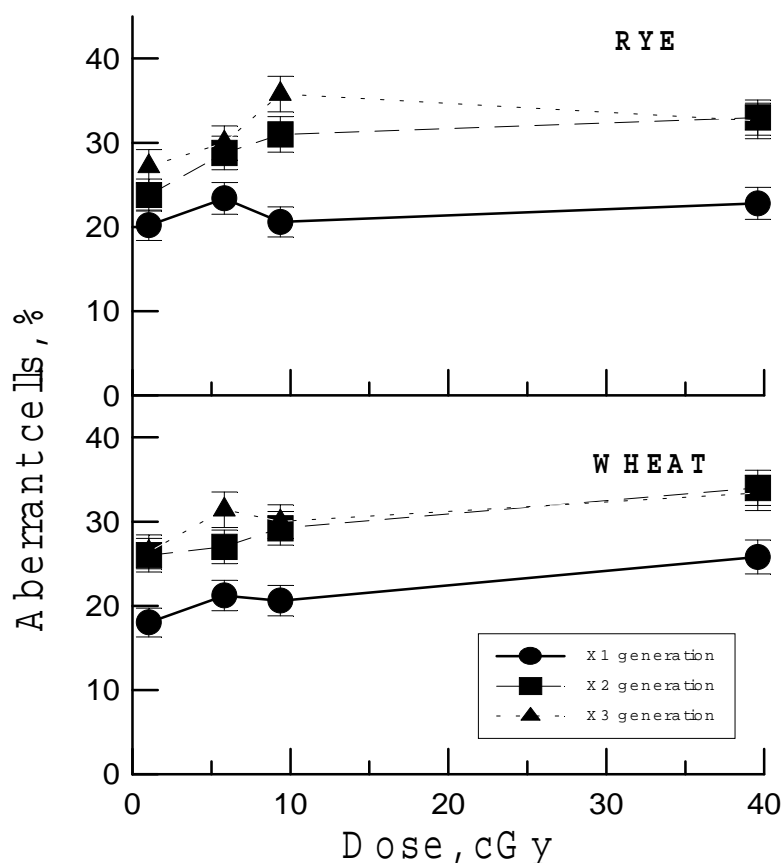

Figure 1. Yield of aberrant cells in three successive generations of winter rye and wheat, grown on contaminated plots.

chronic exposure to low-level radiation possibly alters the genetic structure of population. Response to an external impact, such as an expansion of the gene pool variability providing a potential basis for the subsequent selection of the most adaptable forms, is a reflection of the fundamental mechanisms (grounding the basis for life) [22] that ensure resistance of living systems and their possible adaptation to varying conditions of the environment.

References

1. Alexakhin R.M., Buldakov L.A., Gubanov V.A., et al. Heavy radiation accidents: consequences and countermeasures (in Russian). Izdat Publishers, Moscow, 2001. 752p.
2. Kozubov G.M., Taskaev A.J. Radiobiology and radioecology investigation of tree plants (in the region of the Chernobyl accident) (in Russian). Nauka Publishers, St.Petersburg, 1994. 256 p.
3. Krouglov S.V., Filipas A.S., Alexakhin R.M., Arkhipov N.P. Long-term study on the transfer of ^{137}Cs and ^{90}Sr from Chernobyl-contaminated soils to grain crops. *J. Environ. Radioactivity*. 1997. V. 34. N 3. p. 267-286.
4. Stepanov V.N. Handbook on agronomy basis (in Russian). Kolos Publishers, Moscow, 1969. pp. 119-122.
5. Spirin Ye.V. Formation of absorbed doses in critical organs of cereals on the territory contaminated due to the ChNPP accident (in Russian). *Radiation Biology. Radioecology*. 1997. V. 37. N 3. p. 445-452.
6. Geraskin S.A., Fesenko S.V., Chernyaeva L.G., Sanzharova N.I. Statistical method of empirical distribution analysis of coefficient of radionuclides accumulation in plants (in Russian). *Agricultural Biology*. 1994. N 1. p. 130-137.
7. Polikarpov G.G., Tsytugina V.G. Consequences of the Kyshtym and Chernobyl accidents for hydrobionts (in Russian). *Radiation Biology. Radioecology*. 1995. V. 35. N 4. p. 536-549.
8. Geraskin S.A., Zyablitskaya Ye.Ya., Oudalova A.A. Radiation-induced structural mutations in root meristem of γ -

- irradiated hexaploid wheat seeds (in Russian). *Radiation Biology. Radioecology*. 1995. V. 35. N 2. p. 137-149.
9. Geraskin S.A., Zyablitzkaya Ye.Ya., Oudalova A.A. Structural mutations in root meristem of irradiated barley seeds (in Russian). *Radiation Biology. Radioecology*. 1997. V. 37. N 1. p. 82-90.
 10. Dubinin N.P., Nemtsova L.S. Chromosome and chromatid alterations as a result of radiation effect on phase G₁ in cells of *Allium cepa* seeds (in Russian). *Cytology and Genetics*. 1972. V. 6. N 2. p. 99-102.
 11. Sarapultzev B.I., Geraskin S.A. Genetic basis of radioresistance and evolution (in Russian). Energoatomizdat Publishers, Moscow, 1993. 208 p.
 12. Geraskin S.A., Dikarev V.G., Dikareva N.S., Melnikov B.P., Arysheva S.P. Induction of chromosome aberrations in leaf meristem by combined influence of irradiation and heavy metals. Study of results of multifactor experiment (in Russian). *Radiation Biology. Radioecology*. 1993. V. 33. N 6. p. 890-899.
 13. Geraskin S.A., Dikarev V.G., Dikareva N.S., Oudalova A.A. Effect of ionising irradiation or heavy metals on the frequency of chromosome aberrations in spring barley leaf meristem. *Russian Journal of Genetics*. 1996. V. 32. N 2. p. 240-245.
 14. Geraskin S.A., Dikarev V.G., Nesterov Ye.B., Dikareva N.S. Regularities of cytogenetic effects induced by low doses of ionizing radiation and other technogenous pollutants. In: Proceedings of regional contest of research proposals in natural sciences. Kaluga, 2001. N 2. pp. 318-332.
 15. Abramov V.I., Dineva S.V., Rubanovich A.V., Shevchenko V.A. Genetical consequences of radioactive contamination of *Arabidopsis thaliana* populations from the 30-km ChNPP zone (in Russian). *Radiation Biology. Radioecology*. 1995. V. 35(5), 676-689.
 16. Al'ferovich A.A., Gotlib V.Ya., Pelevina I.I. Appearance of micronuclei in generations of *HeLa* cells irradiated at low doses (in Russian). *News of RAS. Biological series*. 1996. N. 3. p. 261-264.
 17. Shevchenko V.V., Grinikh L.I., Shevchenko V.A. Cytogenetical effects in natural populations of *Crepis tectorum* exposed to chronic irradiation in the Chernobyl NPP region (in Russian). *Radiation Biology. Radioecology*. 1995. V. 35. N 5. p. 695-701.
 18. Kalchenco V.A., Shevchenko V.A., Fedotov I.S. Changes in barley plants radioresistance caused by chronic irradiation (in Russian). *Genetics*. 1981. V. 17. N 1. p. 137-141.
 19. Pelevina I.I., Gotlib V.Ya., Kudryashova O.V., Serebryani A.M., Afanasyev G.G. Genomic instability after low level irradiation (in the zone of Chernobyl disaster and in laboratory conditions) (in Russian). *Radiation Biology. Radioecology*. 1996. V. 36. N 4. p. 546-560.
 20. Cherezhanova L.V., Alexakhin R.M., Smirnov E.G. About cytogenetic adaptation of plants under chronic ionising radiation conditions (in Russian). *Genetics*. 1971. V. 7. N 4. p. 30-37.
 21. Shevchenko V.A., Pechkurenkov V.L., Abramov V.I. Radiation genetics of natural populations (in Russian). Nauka Publishers, Moscow, 1992. 221 p.
 22. Geraskin S.A. Concept of biological effect of low dose radiation on cells (in Russian). *Radiation Biology. Radioecology*. 1995. V. 35. N 5. p. 571-580.

< 1. p.1-10 >

チェルノブイリ原発事故による放射能影響に関する最近のトピックス

今中哲二

京都大学原子炉実験所

チェルノブイリ事故に関し、放射能放出量、汚染面積、被曝量、被曝リスクといった放射能影響に関連する基本的な事項をまとめた。おおざっぱに見積もって、原子炉内にあったヨウ素 131 の 50～60%、セシウム 137 の 30～50%が環境中に放出された。事故発生時の放射能で表すと、それぞれ 4000～5000 万 Ci と 200～400 万 Ci に相当する。ヨーロッパの 13 カ国における、1 平方 km 当り 1Ci 以上のセシウム 137 汚染地域の総面積は、19 万平方 km に達している。もっとも大きな汚染を受けた 3 カ国（ベラルーシ、ウクライナ、ロシア）の総人口に対する集団甲状腺被曝量は 160 万人・Gy と推定されている。また、3 カ国の主な汚染地域に居住している 516 万人に対する事故後 10 年間の集団実効線量は 4 万 2600 人・Sv と推定されている。これらの集団被曝量の値と ICRP1990 年勧告に示されている放射線リスク係数を用いると、1 万 3000 件の甲状腺ガンと 2100 件のその他のガン死が、それぞれの集団において予測される。

本レポートの他の論文では以下のようなことが示されている。ベラルーシでは 2000 年末までにすでに約 4400 件の放射線誘発甲状腺ガンが観察された。また、汚染地域住民や事故処理作業従事者の中で他のガンの増加傾向が認められた。汚染地域の子どもや胎内被曝を受けた子どもにおいて、健康悪化や精神発達障害が観察された。こうした知見のすべては、チェルノブイリ事故による健康影響の大きさや ICRP のリスク係数の適用性について結論するためには、十分に組織された疫学研究が必要なことを示している。

1986 年 6 月 1 日段階でのチェルノブイリ周辺での放射線量率を示す地図を紹介する。その放射線量率を用いて事故直後避難住民の被曝量を推定したところ、30km 圏内のいくつかの村では、かなりの割合の住民において急性放射線症状があった可能性を確認した。

< 2. p.11-27 >

チェルノブイリ型原発：その特徴と事故原因

Mikhail V. MALKO

ベラルーシ科学アカデミー・原子力合同研究所

本報告では、チェルノブイリ型原発の主要な特徴と 1986 年 4 月 26 日に発生した事故の原因について報告する。事故後に行われた科学的調査結果は、炉心設計の欠陥、安全設計規則の無視、ならびに原子炉運転マニュアルの不備がチェルノブイリ事故の主要な原因であったことを示している。さまざまな事故シナリオについて検討した結果、チェルノブイリ 4 号炉では核爆発が起きた可能性が大きく、その爆発力は TNT 火薬 200 トン分と考えられる。

< 3. p.28-44 >

チェルノブイリ原発事故の原因とシナリオ、ならびに敷地周辺への放射能放出

Boris I. GORBACHEV

ウクライナ科学アカデミー・学際科学技術センター「シェルター」

チェルノブイリ事故の原因に関して、新旧データの検討に基づいて現実的なシナリオを考案した。従来の公式見解と違って、新しいシナリオに基づくと、これまでうまく説明されなかった事故時の状況や事故プロセスについて合理的な説明が可能となる。4 号炉の運転員が

緊急停止ボタン AZ-5 を押したのは、炉心で最初の爆発が起きた後であった。それから、もっと強力な第 2 の爆発があり、その振動がチェルノブイリ原発から 100～180km 離れた 3 カ所の地震計に記録された。また、これまでほとんど知られていない、4 号炉建屋周辺への燃料飛散データについても報告する。

< 4. p.45-58 >

崩壊したチェルノブイリ 4 号炉内の核燃料

Volodymyr M. PAVLOVYCH

ウクライナ科学アカデミー・核科学研究所

本報告では、崩壊したチェルノブイリ原発 4 号炉の核的安全性の問題と、「石棺」内の核燃料の分布・存在量の問題とを検討する。石棺内に存在する核燃料の量と放出された量を決定する方法を詳細に検討した。核燃料の存在に関連しては、炉心直下の 305/2 室が核的にもっとも危険な場所であり、そこに特別の注意を払った。これらの知見と核燃料含有物質サンプルの分析結果を基に、核的安全性の計算を行い、仮想的条件下での事故連鎖反応のシナリオを検討した。そうした計算結果の一部を紹介する。

< 5. p.59-73 >

チェルノブイリ原発周辺地域における放射能汚染の解析

*Alexander GAYDAR and Oleg NASVIT**

ウクライナ科学アカデミー・核科学研究所、*イノベーション研究実施企業 “Stroom”

チェルノブイリ事故により大量の放射性物質が環境中に放出され、広大な地域に拡散した。放射性物質の沈着がもっとも大きかったのは、チェルノブイリ原発に隣接する地域である。本報告では、最新の技術を用いたサンプリングならびに測定が実施され、放射能汚染レベルとその組成について信頼できるデータが膨大に得られているチェルノブイリ原発隣接地域の放射能汚染調査について、これまでの調査の概要と最近の状況を介绍する。地形学統計解析を用いたデータ処理によって、汚染レベルと組成の地域的傾向を明らかにし、セシウム 137、ストロンチウム 90、アメリカシウム 241 およびプルトニウム同位体といった核種について詳細な汚染地図を編集することが可能となった。超ウラン元素に対しては、核実験にともなう地球規模汚染とチェルノブイリ由来の汚染を分別し、アメリカシウム 241 による将来の汚染地図を予測した。

著者らによって開発された新しい地形情報技術は、放射能汚染の形成における地形学的要因の解明を可能にしている。こうした地形学的アプローチを基に、高汚染地域の場所や形状の特殊性を説明する試みを行った。

< 6. p.74-85 >

チェルノブイリ原発冷却池における放射能生態系の現状

Oleg NASVIT

イノベーション研究実施企業 “Stroom”

チェルノブイリ原発冷却池における水中放射能モニタリングデータの解析結果は、セシウム 137 濃度の定期的な季節変動を示している。一方、ストロンチウム 90 についてはそのような傾向は認められなかった。セシウム 137 のこの変動現象は、微生物活動によって支配される、湖底土から水中へのセシウム 137 移行の季節変化によるものであることが強く示唆された。水深の大きな湖底における汚泥中でのセシウム 137 の深度分布分析もこの推測を支持

している。

2001年8月に実施した調査によって得られたデータは、供用停止間近である冷却池が、放射能生態学的に安定した段階にあることを示している。冷却池の湖底土に蓄積されている放射エネルギーは、セシウム137、ストロンチウム90、アメリカシウム241について、それぞれ4,400、650、18 Ciと推定されている。供用停止にともなって湖水面が自然レベルまで低下した場合、セシウム137の70%、ストロンチウム90の50%、アメリカシウム241の80%が、水面下にとどまるであろうと評価されている。冷却池に生息するさまざまな魚類、水生植物、貝類の汚染データも紹介する。

< 7. p.86-96 >

ロシアの汚染地域におけるヨウ素131汚染、甲状腺被曝量、甲状腺ガン
Valery F. STEPANENKO, Evgeny M. PARSHKOV, Viktor A. SOKOLOV, Mark Yu. ORLOV, Alexander I. IVANNIKOV, Valery G. SKVORTSOV, Elena K. IASKOVA, Timofey V. KOLIZHENKOV, Irina G. KRYUKOVA, Anatoly F. TSYB
ロシア医学アカデミー・医学放射能研究センター

チェルノブイリ事故により約1,800PBqのヨウ素131が環境中に沈着した。ロシアで最も汚染が大きかったのは、ブリャンスク州、ツェラ州ならびにオリョール州であった。ヨウ素131の約80%は事故後の最初の一週間で沈着した。この放射能の崩壊は早い(半減期約8日)ので、沈着量の直接的な測定データは限られている。一方、長半減期であるセシウム137については広汎な測定が実施されている。その結果、甲状腺被曝量を推定するために、ヨウ素131とセシウム137の放射能比を用いて、ヨウ素131の土壌沈着量を推定した。甲状腺中のヨウ素131を直接測定したデータと、土壌中のヨウ素131とセシウム137測定データを組み合わせて、甲状腺被曝量を評価するための経験式を考案し、1986年にヨウ素131が測定されていない地域について適用した。

甲状腺中ヨウ素131の直接測定結果に基づく被曝量評価によると、甲状腺被曝量のメディアン値は、カルーガ州(7地区)については子供で30mGy、大人で8mGyであった。ブリャンスク州5地区の大人に対するメディアン値は、30mGyから140mGyであった。セシウム137の汚染レベルが3.7kBq/m²(0.1Ci/km²)以上の地域における集団甲状腺被曝量は、ブリャンスク、オリョール、ツェラ、カルーガの各州について、72,600、16,900、13,400および3400人・Gyであった。

最も汚染されたブリャンスク州で、事故のときに0歳から50歳であった住民の1986年~2000年における甲状腺ガン発生率データを紹介する。事故後の最初の5年(1986-1990)は、年齢グループ別(0-4歳、5-9歳...)の甲状腺ガン発生率は安定していた。調査されたすべての年齢グループで1991年から甲状腺ガンの着実な増加が始まった。ブリャンスク州の最汚染4地区での甲状腺ガン例(事故時0-18歳)26件について、半経験モデルを基に個人線量を評価したところ、甲状腺ガン発生の被曝量への依存性が認められた。

< 8. p.97-102 >

ウクライナ・ジトーミル州ステパニフカ村の食品放射能汚染：1992年と2001年
Volodymyr TYKHYY
ウクライナ科学アカデミー・サイバネティックス研究所

チェルノブイリ事故によって汚染されたある村で、食品サンプルの放射能汚染測定を1992年と2001年に実施した。そのステパニフカ村はチェルノブイリ原発の西方120kmにあり、

セシウム 137 による地表汚染はその地域での典型的な値 (3~5 Ci/km²) である。調査を行ったのは、ウクライナの NGO「緑の世界」と国際ルネッサンス基金とによって設立された、キエフ独立環境ラボである。

調査の結果、2001 年の牛乳中のセシウム 137 濃度は、1992 年に比べ 9 分の 1 となっていたが、野生のキノコやベリーの汚染は同じレベルにとどまっていた。食品と飲料水を通してのステパニフカ村の人々の年間セシウム 137 摂取量は、1992 年に比べ 2001 年は約 3 分の 1 に減少していた。一方、セシウム 137 の減少傾向と異なり、牛乳や乾燥ベリー中のストロンチウム 90 濃度は、1992 年に比べ 2001 年は有意に大きかった。

< 9. p.103-111 >

ベラルーシ食品中のチェルノブイリ事故由来の放射性物質濃度

*Vladimir P. MATSKO and Tetsuji IMANAKA**

ベラルーシ科学アカデミー・放射線生物学研究所、*京都大学原子炉実験所

ベラルーシの食品と飲料水について、チェルノブイリ事故由来の放射能汚染に関する最近のデータをレビューした。ストロンチウム 90 とセシウム 137 が人々に内部被曝をもたらす主要な核種である。公営農業部門 (コルホーズ、農業組合) からの農産品の汚染レベルは、内部被曝量が年間 1mSv 以下になるよう定められた現行の法的基準 RAL-99 を概して下回っている。一方、個人的農業部門における農産品では、RAL-99 を上まわる汚染がしばしば認められ、なかでも、もっとも深刻な汚染をうけたゴメリ州の集落において顕著である。汚染地域における畑以外からの食品、すなわちキノコ、ベリー、魚、野獣の肉については特別な注意が必要である。たとえば、ゴメリ州のある集落では生キノコ 1 kg 当り約 37,000Bq というセシウム 137 汚染が記録されており、この値は RAL-99 基準値の 100 倍である。飲料水についてはきわめて良好な状況にあり、この 10 年間、RAL-99 を越える値は記録されていない。

< 10. p.112-122 >

チェルノブイリ周辺における魚の放射能汚染の長期的観察

Igor N. RYABOV

ロシア科学アカデミー・エコロジー進化問題研究所

チェルノブイリ事故によって放射能汚染を受けたさまざまな水系に生息する漁獲対象魚種について、セシウム 137 蓄積量の変動を調査した。最も大きなセシウム 137 濃度は、1986 年にチェルノブイリ原発冷却池の魚に記録された、生重量 1kg 当り 500kBq であった。この 15 年間すべての水系において魚の放射能レベルは低下しているが、その低下速度はさまざまである。食物連鎖の階層に依存した、セシウム 137 蓄積の特性が観察されている。事故後数ヶ月間は、キエフ貯水湖の非肉食魚種のセシウム 137 濃度は、カワカマスの 10 倍であった。1987 年以降は、捕食魚種の濃度が非捕食魚種の 2~3 倍となった。カワカマスやパーチといった魚が高濃度を示している。2001 年までに、魚のセシウム 137 濃度は、冷却池で生重量 1 kg 当り 5kBq 以下に、テレフ川で 0.09kBq 以下に、キエフ貯水湖で 0.5kBq 以下となった。一方、チェルノブイリ原発から 100~200km も離れているものの、ロシア・ブリャンスク州やベラルーシ・モギリョフ州にあって、カリウムイオン濃度が低くよどんだ閉塞性の湖では、高濃度のセシウム 137 が継続している。生殖臓器の異常が捕食性魚種において最も多く観察されている。

< 11. p.123-141 >

チェルノブイリ事故処理作業従事者の EPR による被曝量評価

Vadim CHUMAK

ウクライナ医学アカデミー・放射線医学研究センター

本報告では、歯エナメル EPR を用いた被曝量評価に関して、ウクライナでの研究開発と応用の現状を紹介する。ここで述べる EPR 被曝量評価の手順は、SCRM (放射線医学科学センター) によって開発され、チェルノブイリ事故処理作業員 (リクビダートル) の被曝量を遡って評価するために実際に応用されている。SCRM では、オリジナルな ESR 被曝量評価手順をあみ出すとともに、見せかけ誤差要因の究明とその排除のために精力的に実験研究を実施した。そうして考案された EPR 被曝量評価手順は、高精度、高感度かつ再現性を持ち、技術的実用性を備えている。SCRM の EPR 被曝量評価手順の高い品質は、一連の国際比較測定を含めた品質保証プログラムによって証明されている。恒常的で全国的なネットワークを確立して歯を収集することが、ウクライナにおいて EPR 被曝量評価を成功させるもうひとつのキーポイントとなっている。

チェルノブイリ被災者への医療支援において、EPR 被曝量評価を応用するための最適な方法について述べる。ウクライナにおける主要な用途は、事故処理作業員の被曝量を高精度で評価することと、EPR によって得られた値を他の被曝量評価方法によって得られた値の基準値として用いることである。後者は、チェルノブイリ事故に対する EPR 被曝量評価手法のもっとも効果的な活用である。EPR 線量評価は、FISH、ADR、SEAD、RADRUE といった遡及的被曝量評価方法の確かさを検証するために使われている。EPR 被曝量評価は現在、チェルノブイリ被災者の医学的追跡において必須の役割を果たしている。

< 12. p.142-151 >

ロシアの放射能汚染地域住民の歯エナメル EPR 測定を用いた遡及的被曝量評価

Alexandre I. IVANNIKOV, Valeri G. SKVORTSOV, Valeri F. STEPANENKO

ロシア医学アカデミー・医学放射能研究センター

ロシア・ブリャンスク州の放射能汚染地域住民を対象に、歯エナメル EPR スペクトル測定を用いて実施した大規模な被曝量評価結果を報告する。対照グループには、隣接するカルーガ州の非汚染地域住民を選んだ。放射能汚染にともなう過剰な放射線被曝量は、自然放射線バックグラウンドによる歯の年齢分の EPR シグナルへの寄与を差し引いて決定した。汚染地域ごとに住民の平均被曝量を求めた。平均被曝量の誤差は、検査対象人数と個人的な結果のバラツキに応じて、4 から 25mGy であった。平均被曝量は地域によって大きく変動し、最大で 70mGy であった。歯エナメル EPR スペクトルによる平均外部被曝量の値は、直接的な被曝量測定値や他の遡及的被曝量評価値と概して一致した。グループ内の何人かには、平均被曝量を大きく上回る被曝が認められた。このことは、歯エナメル EPR 測定を用いて、大きな被曝を受けた住民を見出し、放射線リスクの大きい医学的モニタリング対象グループに含めることが可能であることを示している。

< 13. p.152-159 >

ベラルーシの汚染地域住民に対する放射線リスクの評価

Vladimir A. KNATKO, Mikail M. KOMOCHKOV, Alla E. YANUSH*

ベラルーシ科学アカデミー・放射線生物学研究所、*ロシア合同核研究所

ベラルーシの汚染地域に居住する大人について、チェルノブイリ事故後の異なる期間の集積被曝量を評価した。1986年から2001年間の平均集積被曝量は、南部汚染地域と東部汚染地域でそれぞれ50mSvと39mSvと評価された。得られた被曝量データを用いて、最近の放射線生物学の研究に基づいて考案された2重防護モデル(TDR)によって、汚染地域の大人に対するガン死の相対過剰リスクを求めた。その結果、チェルノブイリ事故によるガン死の相対過剰リスクは生涯で5-6%となった。この値を、国際放射線防護委員会1990年勧告に基づく値と比較してみると、TDRモデルの値の方が約6倍大きかった。

< 14. p.160-167 >

ヨウ素 131 吸入によるベラルーシ汚染地域住民の甲状腺被曝量

Vladimir A. KNATKO and Inga N. DOROZHOK

ベラルーシ科学アカデミー・放射線生物学研究所

土壌サンプルにおける¹³¹Iと¹³⁷Csの関係と、各集落における¹³⁷Cs汚染データとを用いて、ベラルーシの東部汚染地域と南部汚染地域の各集落(1,079カ所と316カ所)での¹³¹Iの沈着密度を推定した。その結果によると、¹³¹I沈着密度の90%範囲は、東部汚染地域で500~2,300kBq/m²、南部汚染地域で700~3,500kBq/m²であった。¹³¹Iの沈着密度を用いて、それぞれの地域での放射能沈着の時期と特徴を考慮しながら、¹³¹I吸入にともなう甲状腺被曝量を求めた。吸入にともなう大人の平均甲状腺被曝量は、東部汚染地域で3から80mSv、南部汚染地域で40から370mSvとなり、それぞれの中央値は、20mSvと130mSvとなった。評価手法にともなう甲状腺被曝量の不確かさについても考察した。

< 15. p.168-187 >

ロシア全国医学被曝登録に基づく疫学研究：チェルノブイリ事故処理作業者に観察されたガン影響と非ガン影響

Marat M. MAKSIOUTOV

ロシア医学アカデミー・医学放射能研究センター、国家放射線疫学登録

1986年6月、ソ連保健省は放射線被曝者全登録という大規模なプログラムを開始した。オブニンスク市のロシア医学アカデミー・医学放射能研究所(現在のロシア医学アカデミー・医学放射能研究センター)が、登録プログラムの創設と管理を行う中心組織に指定された。国家登録の課題は2つであった。第1に、チェルノブイリ事故にともなう健康影響を評価し、その影響を緩和するための最適な戦略を考案すること、第2に、放射線被曝にともなう実際のリスクを評価するための長期的な疫学研究を組織することであった。2001年12月現在、ロシア全国医学被曝登録(RNMDR)は、ロシア領内に居住するチェルノブイリ事故被災者58万5121人の医療ならびに被曝データをもっている。そのうち、事故処理作業者は18万7596人(登録の32.1%)である。

本論文では、RNMDRに含まれる事故処理作業者集団の医学的および被曝量データを解析した結果を示す。放射線被曝にともなうガン影響と非ガン影響についてとくに留意した。ICRPによって勧告されている放射線被曝リスクは主として1945年の広島・長崎の被爆生存者集団(LSSコホート)の疫学調査に基づいている。統計的に有意な日本の被曝者集団の被曝リスク係数は、0.3Sv以上の個人被曝量範囲から得られている。低被曝量域(0.2Svまで)については、外挿に基づいているだけで、疫学的に直接的に確認されたものではない。したがって、RNMDRは、事故処理作業者集団に対する医学的ならびに被曝の情報に基づき、低被曝量のリスクを明らかにできる最初の研究である。

本報告は、以下の5つの章で構成される。第1章は、RNMDRの組織と概要を述べ、事故処理作業員集団の特徴を述べる。第2章から第4章では、国家登録の実際のデータに基づいて、放射線リスクを推定するための研究を示す。白血病と固形ガン、ならびに非ガン疾病について、事故処理作業員での発生率に基づく放射線リスクについて議論する。最後の第5章では、事故処理作業員の死亡率を扱い、放射線被曝との関係を示す。本報告の内容は、国家登録の専門家によってまとめられ、これまでに著名なロシアと国際的科学雑誌に発表された論文に基づいている。

< 16. p.188-201 >

チェルノブイリ事故によるウクライナ住民への医学的影響研究によって
得られた疫学的知見

Anatoly Ye. PRYSYAZHNYUK, Volodymir G. GRISHTSHENKO, Zoya P. FEDORENKO,
Ludmila O. GULAK*, Mykola M. FUZIK*
ウクライナ医学アカデミー・放射線医学研究センター
*ウクライナ医学アカデミー・腫瘍研究所

チェルノブイリ事故による被害を受けた、さまざまなウクライナ人集団の健康状況を明らかにすることは、事故被害低減にあたってもっとも重要な問題のひとつである。健康影響やチェルノブイリ被災者の登録データに基づく多くの科学研究が、事故処理作業従事者、プリリャチ市や30km圏からの避難住民、放射能汚染地域住民といった被災者集団の健康悪化を示している。チェルノブイリ事故によるもっとも顕著な確率的影響は、これらのウクライナ人集団での甲状腺ガン増加として現われている。また、女性の乳ガンと、その他のいくつかの固形ガンについても増加が示唆されている。確率的ならびに非確率的影響について今後の長期的な調査が必要である。

< 17. p.202-230 >

チェルノブイリ事故によって胎内で急性被曝を受けた子供たちの知性と脳障害

*Angelina I. NYAGU, Konstantin N. LOGANOVSKY, Tatiana K. LOGANOVSKAJA,
Viktor S. REPIN*, Stanislav Yu. NECHAEV**
ウクライナ医学アカデミー・放射線医学研究センター、放射能臨床研
*ウクライナ医学アカデミー・放射線医学研究センター、放射能障害予防疫学研

本研究の目的は、胎内において急性的な被曝を受けた子供たちの精神的、神経生理的、神経精神的状态を明らかにすることである。チェルノブイリ事故の際に胎内被曝を受けて母親とともにキエフへ移住してきた子供100人(1986年4月26日から1987年2月26日の間に出生)をランダムに選び、彼らのクラスメート100人を対照グループに選んで調査した。調査項目は、Wechsler 子供知能指数(WISC)、脳電流グラフ(EEG)ならびに臨床検査である。被曝グループの胎児被曝量は11-92mSvで、対照グループでは0-3mSvであった。また甲状腺被曝量はそれぞれ、0.2-2Gyと0-0.04Gyであった。被曝グループの平均言語的IQはコントロールグループより低く(105.3±13.1 対 118.1±13; $p < .001$)、平均全スケールIQもコントロールより低かった(112.1±15.4 対 120.9±11.5; $p < .001$)。被曝グループではさらに、次のようなことが観測された。言語能力低下をとともなうWISC 実行・言語指数の不一致、低電圧・高周波のEEGパターンと左脳機能低下の頻度増加、波と波の増加($p < 0.001$)と波と波の低下($p < 0.001$)、発作的で器質的な精神障害頻度の増加、身体的自律神経異常、精神

の発達障害、挙動および情緒障害である。大脳の機能障害は病因的にさまざまであった。本研究は、0.2~2Gy の胎内甲状腺被曝ならびに 11~92mSv の胎児被曝が検出可能な大脳障害をもたらすことを示している。

< 18. p.231-239 >

チェルノブイリ事故に被災したベラルーシの子供たちの健康状態：事故から 16 年

*Alexander N. ARYNCHYN, Tatiana V. AVHACHEVA, Nika A. GRES,
Ekaterina I. SLOBOZHANINA**

ベラルーシ保健省・放射線医学内分泌学臨床研究所

*ベラルーシ科学アカデミー・光生物学研究所

チェルノブイリ事故により被災したベラルーシの子供たちの健康状態を調査するため、前向き固定集団調査を実施した。被曝グループは放射能汚染地域にずっと居住している 133 人の子供で、対照グループは自然放射線だけの地域に住んでいる 186 人の子供である。調査期間中、被曝グループが余分に受けた年間実効線量は 0.13~2.24mSv であった。両グループのすべての子供は、1990 年~2001 年の間に少なくとも 2 回の臨床検査を受けた。鉛、カドミウム、水銀といった重金属の尿中濃度も測定した。臨床検査の結果は、両グループにおいて、自覚症状や臨床的症状が時間とともに増加していることを示している。自律神経系失調症にともなう心臓循環器系疾患と消化器系疾患の増加がもっとも顕著であった。1 回目と 2 回目の両方の臨床検査において、すべての病理症状で、被曝グループでの頻度が対照グループよりも大きかった。被曝グループにおける大きな相対リスクが、低血圧症（1 回目と 2 回目でそれぞれ RR = 2.21 と 3.73）ならびに心臓疾患（RR = 4.66 と 3.33）で認められた。ベラルーシの子供たちの健康悪化は、環境要因によって増加している病気に対して緊急の予防対策を行う必要性を示している。

< 19. p.240-255 >

チェルノブイリ事故によるベラルーシでの甲状腺ガン

Mikhail V. MALKO

ベラルーシ科学アカデミー・原子力合同研究所

ベラルーシにおける甲状腺ガンの発生率と死亡率の評価を行った。1987 年から 2000 年の間にベラルーシでは放射線被曝によって約 4400 件の甲状腺ガンが発生し、そのうち 692 件が子供の甲状腺ガンで、3709 件が青年・大人の甲状腺ガンであった。そのうち致死的な甲状腺ガンは約 350 件であった。甲状腺ガン発生率と集団甲状腺被曝量から求めた、甲状腺ガン発生率の絶対過剰リスク（EAR）は、1 万人・年・Gy 当り 2.5~5.0 件となった。甲状腺ガン死の EAR は、1 万人・年・Gy 当り 0.20~0.40 件であった。一方、甲状腺ガン発生率の相対過剰リスク（ERR）は、1 Gy 当り 11.2~22.4 となった。本報告で明らかとなった甲状腺ガンリスクは、チェルノブイリ事故被災者に比べ数 1000 倍も大きな被曝量率で放射線を受けた原爆被爆生存者を基に得られた値より大きい。顕著な潜伏期間が認められていないことも、チェルノブイリ事故によるベラルーシの甲状腺ガンのもうひとつの特徴である。

< 20. p.256-267 >

放射線被曝事故によるヒトリンパ球染色体異常の解析

*Galina SNIGIRYOVA and Vladimir SHEVCHENKO**

ロシア保健省・レントゲン放射能学科学センター、

目的：チェルノブイリ事故処理作業従事者（リクビダートル）の細胞遺伝学的検査を行い、染色体異常の頻度に基づいて被曝量を遡及的に評価すること。

材料と方法：主として1986年と1987年にチェルノブイリ事故ゾーンで作業にあたった1500人以上のリクビダートルを対象に1986年から検査を行った。すべての対象者を、不安定型染色体異常を調べる従来の細胞遺伝学的手法を用いて検査した。また、クルチャトフ研の専門家12人を含む64人については、対称転座を調べることで可能なFISH法で検査した。

結果：1986年の検査結果では、リクビダートル集団における2動原体頻度が対照集団に比べ16倍も大きかった。その後、その頻度は顕著に減少した。しかしながら、事故から15年後においても、リクビダートル集団の2動原体染色体異常頻度は対照集団に比べ有意に大きかった。2動原体の頻度と被曝量・効果関係の校正曲線データを用いて、1986年に検査したリクビダートルの被曝量を推定した。平均被曝量は0.14Gyであった。転座を調べた52人のリクビダートルでの平均被曝量は0.16Gyであった。対照集団に比べ大きな転座頻度を示した18人の個人被曝量推定値は、0.22Gyから1.0Gyの間であった。

1996年に、22人のクルチャトフ研究所の専門家を検査した。大部分（13人）において、末梢血液中リンパ球の2動原体頻度が対照集団値に比べ有意に増加していた。5人の被検査者では、複数の染色体異常を含む細胞が認められた。3人は、とりわけ大きな被曝を受けており、その2動原体染色体頻度は、対照集団の100～1000倍であった。転座データに基づく、5人のクルチャトフ研専門家の被曝量は0.21～2.51Gyであった。これらの被曝量推定値には、さまざまな被曝量率で数年間にわたって被曝を受けたことに対する修正を考慮に入れていない。これらのことを考慮に入れるならば、推定被曝量はもっと大きくなるであろう。

結論：細胞遺伝学的手法は、細胞の遺伝的構造を明らかにするのに十分な感度を備えている。不安定型染色体異常の分析は、原子力事故にともなう多数の放射線被曝者をモニタリングするにあたって不可欠な方法である。細胞遺伝学的検査データは、さまざまな疾病に対するリスク増加集団を決定する上で重要な指標となりうる。FISH法による安定的転座の分析は、生物学的被曝量評価において、今後もっとも期待される手法のひとつである。転座頻度に基づく被曝量の検出限界値は、20～25cGyである。

< 21. p.268-276 >

チェルノブイリ事故処理作業における染色体異常の追跡調査

Natalia M. SLOZINA and Elizaveta G. NERONOVA

ロシア緊急事態省・全口緊急放射線医療センター

1986年から1989年にかけてチェルノブイリ事故処理作業に従事した359人を対象に細胞遺伝学的検査を実施した。検査時期は被曝をうけてから6年から12年後にわたっている。事故処理作業従事者において、断片対、2動原体、環状染色体といった染色体型異常の頻度が、対照グループに比べ有意に増加していた。染色分体型交換は、事故処理作業従事者にのみ認められた。1986年に作業に従事した243人を対象に、被曝マーカーの経年的変化を調べた。2動原体頻度の経年変化は、被曝後8年から12年にかけて増加を示すという、説明しがたい傾向を示した。さまざまなタイプの染色体異常頻度と、喫煙、コーヒー、アルコール消費量などといった生活習慣要因との相関性を、ステップ型多重因子回帰法で解析した。統計的に有意な相関性は、喫煙と染色分体型異常にのみ認められ、事故処理作業従事者のうち、喫煙者サブグループでの頻度が非喫煙サブ

グループより大きかった。被曝からかなり後の時期においても不安定型染色体異常の頻度が増加していることは、被曝の直接的作用に加えて、別の遺伝学的負荷の存在を想定させるものである。

< 22. p.277-286 >

チェルノブイリ原発 30km 圏無人ゾーン居住者の血液リンパ球染色体異常
Larysa BEZDROBNA, Tetyana TSYGANOK, Olena ROMANOVA, Larysa TARASENKO,
Volodymyr TRYSHYN, Ludmila KLIMKINA
ウクライナ科学アカデミー・核研究所

1998 年から 1999 年にかけて、チェルノブイリ原発 30km 圏無人ゾーンの自発的居住者 33 人と、キエフ州ヤホティン地区の住民 31 人を対象に、細胞遺伝学的比較調査を実施した。それぞれの居住区域におけるセシウム 137、ストロンチウム 90、プルトニウム 238,239+240 の地面汚染密度は、前者においてそれぞれ 74-477 kBq/m²、33-288 kBq/m²、1.5-10.0 kBq/m² で、後者においてそれぞれ 1.9-5.8 kBq/m²、0.6-2.8 kBq/m²、0.01-0.05 kBq/m² であった。無人ゾーンの放射線状況に関するさまざまなデータに基づいて、事故後の居住期間全体にわたる自発的居住者の全身実効線量は 30 - 333mSv と評価された。無人ゾーン自発的居住者の染色体異常細胞頻度と染色体異常頻度の平均値は、ヤホティン地区住民にくらべ有意に大きかった。同時に、ヤホティン地区住民の値は、文献に示されている自然発生レベルよりも大きかった。染色体異常の個人的バラツキは、無人ゾーン居住者の方がヤホティン地区住民に比べ有意に大きかった。両グループは、細胞当たり染色体異常数の分布においても異なっていた。無人ゾーン居住者 20 人について 2001 年に再検査を実施したところ、染色体型染色体異常の有意な減少が認められたが、それは主として染色体断片頻度の減少によるものであった。しかしながら、染色体異常全体の頻度は 1998-99 年と 2001 年では変化は認められなかった。

< 23. p.287-296 >

事故後の数年においてチェルノブイリ地域で観察された農作物に対する
放射線の細胞遺伝学的影響

Stanislav A. GERASKIN, Vladimir G. DIKAREV, Yevgenia Ya. ZYABLITSKAYA,
Alla A. OUDALOVA, Yevgeniy V. SPIRIN
ロシア農学アカデミー・農業放射能学農業生態学センター

1986 年のチェルノブイリ原発事故にともなう放射能汚染の農作物への細胞遺伝学的影響を調査した。外部からの線と線が中心であった事故後の急性期（1986 年）には、細胞遺伝学の基礎実験が示すのと同様な、急性線照射にともなう効果が認められた。（被曝線量が低く慢性的となった）1987 年～1989 年には、チェルノブイリ原発周辺 10km の植物の葉の分裂組織での細胞遺伝学的異常が、汚染レベルに依存して増加した。細胞遺伝学的損傷の減少は、放射線被曝の減少よりかなり遅れて現われた。3 世代にわたるライ麦と小麦を観察して遺伝的な影響を調べたところ、第 2 世代と第 3 世代において慢性的放射線照射に対する細胞遺伝学的損傷の感受性が増加した。