

NASA/TM—2016-218911

AIAA—2015—3809



Modular Stirling Radioisotope Generator

*Paul C. Schmitz
Power Computing Solutions, Inc., Avon Lake, Ohio*

*Lee S. Mason and Nicholas A. Schifer
Glenn Research Center, Cleveland, Ohio*

NASA STI Program . . . in Profile

Since its founding, NASA has been dedicated to the advancement of aeronautics and space science. The NASA Scientific and Technical Information (STI) Program plays a key part in helping NASA maintain this important role.

The NASA STI Program operates under the auspices of the Agency Chief Information Officer. It collects, organizes, provides for archiving, and disseminates NASA's STI. The NASA STI Program provides access to the NASA Technical Report Server—Registered (NTRS Reg) and NASA Technical Report Server—Public (NTRS) thus providing one of the largest collections of aeronautical and space science STI in the world. Results are published in both non-NASA channels and by NASA in the NASA STI Report Series, which includes the following report types:

- **TECHNICAL PUBLICATION.** Reports of completed research or a major significant phase of research that present the results of NASA programs and include extensive data or theoretical analysis. Includes compilations of significant scientific and technical data and information deemed to be of continuing reference value. NASA counter-part of peer-reviewed formal professional papers, but has less stringent limitations on manuscript length and extent of graphic presentations.
- **TECHNICAL MEMORANDUM.** Scientific and technical findings that are preliminary or of specialized interest, e.g., “quick-release” reports, working papers, and bibliographies that contain minimal annotation. Does not contain extensive analysis.
- **CONTRACTOR REPORT.** Scientific and technical findings by NASA-sponsored contractors and grantees.
- **CONFERENCE PUBLICATION.** Collected papers from scientific and technical conferences, symposia, seminars, or other meetings sponsored or co-sponsored by NASA.
- **SPECIAL PUBLICATION.** Scientific, technical, or historical information from NASA programs, projects, and missions, often concerned with subjects having substantial public interest.
- **TECHNICAL TRANSLATION.** English-language translations of foreign scientific and technical material pertinent to NASA's mission.

For more information about the NASA STI program, see the following:

- Access the NASA STI program home page at <http://www.sti.nasa.gov>
- E-mail your question to help@sti.nasa.gov
- Fax your question to the NASA STI Information Desk at 757-864-6500
- Telephone the NASA STI Information Desk at 757-864-9658
- Write to:
NASA STI Program
Mail Stop 148
NASA Langley Research Center
Hampton, VA 23681-2199



Modular Stirling Radioisotope Generator

Paul C. Schmitz
Power Computing Solutions, Inc., Avon Lake, Ohio

Lee S. Mason and Nicholas A. Schifer
Glenn Research Center, Cleveland, Ohio

Prepared for the
13th International Energy Conversion Engineering Conference (IECEC)
sponsored by the American Institute of Aeronautics and Astronautics
Orlando, Florida, July 27–31, 2015

National Aeronautics and
Space Administration

Glenn Research Center
Cleveland, Ohio 44135

This report contains preliminary findings,
subject to revision as analysis proceeds.

Trade names and trademarks are used in this report for identification
only. Their usage does not constitute an official endorsement,
either expressed or implied, by the National Aeronautics and
Space Administration.

This work was sponsored by the Fundamental Aeronautics Program
at the NASA Glenn Research Center.

Level of Review: This material has been technically reviewed by technical management.

Available from

NASA STI Program
Mail Stop 148
NASA Langley Research Center
Hampton, VA 23681-2199

National Technical Information Service
5285 Port Royal Road
Springfield, VA 22161
703-605-6000

This report is available in electronic form at <http://www.sti.nasa.gov/> and <http://ntrs.nasa.gov/>

Modular Stirling Radioisotope Generator

Paul C. Schmitz
Power Computing Solutions, Inc.
Avon Lake, Ohio 44012

Lee S. Mason and Nicholas A. Schifer
National Aeronautics and Space Administration
Glenn Research Center
Cleveland, Ohio 44135

Abstract

High-efficiency radioisotope power generators will play an important role in future NASA space exploration missions. Stirling Radioisotope Generators (SRGs) have been identified as a candidate generator technology capable of providing mission designers with an efficient, high-specific-power electrical generator. SRGs high conversion efficiency has the potential to extend the limited Pu-238 supply when compared with current Radioisotope Thermoelectric Generators (RTGs). Due to budgetary constraints, the Advanced Stirling Radioisotope Generator (ASRG) was canceled in the fall of 2013. Over the past year a joint study by NASA and the Department of Energy (DOE) called the Nuclear Power Assessment Study (NPAS) recommended that Stirling technologies continue to be explored. During the mission studies of the NPAS, spare SRGs were sometimes required to meet mission power system reliability requirements. This led to an additional mass penalty and increased isotope consumption levied on certain SRG-based missions. In an attempt to remove the spare power system, a new generator architecture is considered, which could increase the reliability of a Stirling generator and provide a more fault-tolerant power system. This new generator called the Modular Stirling Radioisotope Generator (MSRG) employs multiple parallel Stirling convertor/controller strings, all of which share the heat from the General Purpose Heat Source (GPHS) modules. For this design, generators utilizing one to eight GPHS modules were analyzed, which provided about 50 to 450 W of direct current (DC) to the spacecraft, respectively. Four Stirling convertors are arranged around each GPHS module resulting in from 4 to 32 Stirling/controller strings. The convertors are balanced either individually or in pairs, and are radiatively coupled to the GPHS modules. Heat is rejected through the housing/radiator, which is similar in construction to the ASRG. Mass and power analysis for these systems indicate that specific power may be slightly lower than the ASRG and similar to the Multi-Mission Radioisotope Thermoelectric Generator (MMRTG). However, the reliability should be significantly increased compared to ASRG.

Introduction

The Radioisotope Power Systems (RPS) Program Office recently completed the Nuclear Power Assessment Study (NPAS), which considered RPS for future NASA missions (Ref. 1). One part of the NPAS considered future Stirling Radioisotope Generator (SRG) designs, which included both higher power levels and convertor redundancy. In general, these generator designs were relatively small deviations from the Advanced Stirling Radioisotope Generator (ASRG) architecture. This study revisits the SRG architecture choices made in the NPAS. The motivation to consider new generator designs is twofold. First, there is the desire to use a single Stirling convertor and controller module as a building block, which can be used to provide a wide range of generator output powers. Second, a new generator design may enable better generator level reliability than previous designs.

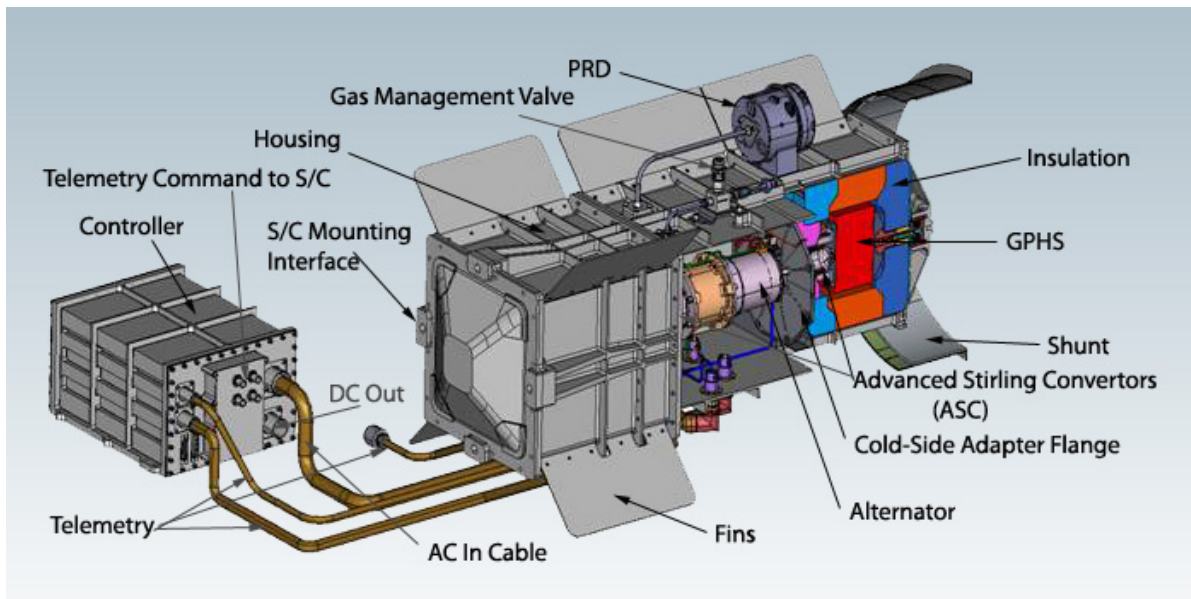

Figure 1.—Advanced Stirling Radioisotope Generator.

The ASRG (Fig. 1) design consists of two 80-W Stirling convertors with one General Purpose Heat Source (GPHS) module placed adjacent to each Stirling convertor heater head. The heat generated in the GPHS module(s) is conducted via an interface called the hot-side attachment (HSA) to the Stirling convertor (Ref. 2). The Stirling convertor converts the heat into electrical power and the cycle waste heat is rejected through the cold-side adapter flange (CSAF) to the housing/radiator. The housing/radiator in the ASRG serves to contain the insulation, provide structural rigidity to the entire assembly, and contain an inert cover gas required during Assembly, Test, and Launch Operations (ATLO). The controller Advanced Stirling Convertor Controller Unit (ACU) is used to synchronize the oscillating 102 Hz motion of Stirling convertors and convert the single phase alternating current (AC) to direct current (DC), and includes a backup controller card in the case of a failure. Because there is no thermal linkage between the heat sources, heat from the GPHS modules is not shared and therefore in the event of a convertor failure, the operating convertor could not utilize the heat from the failed convertor. This results in the generator producing 45 percent of its full power after a convertor failure while also increasing the shaking force from the generator. At the end of the ASRG project, the user community was still addressing areas of concern: vibration, redundancy, fault tolerance, and reliability (Ref. 3).

In several studies performed during the NPAS mission studies, backup generators were required in order to meet projected reliability requirements from the mission planners. This led to an increase in isotope consumption and an increase in total power system mass. In an attempt to remove the backup generator requirement, a number of new SRG designs were considered, which could provide full power operation after convertor failures and with the ability to share the heat generated by the GPHS modules. Figure 2 shows some of these generator concepts from the NPAS. Generally, these designs consisted of stacked GPHS modules with the Stirling convertor acceptors located near the GPHS modules. All of these RPS designs used from two to four Stirling convertors and were operated in coupled pairs to reduce vibration. For generators larger than the ASRG, the designs used a common 200-W AC convertor designated “ASC-H.” Even with the shared heat and redundant Stirling convertors, the reliability and fault tolerance were a potential concern. Additionally, most of the designs required heat pipes to distribute the heat from the GPHS modules and transfer the waste heat to the radiator. At the conclusion of the NPAS, a 300-W DC-class Stirling generator using either two or four convertors was identified as a promising option for further study.

	ASRG	SRG-200	SRG-400	SRG-500		KP-1
BOM Power	140 We	193 We	370 We	495 We		1097 We
No. GPHS	2	3	6	8		Fission
Heat Source Config.	Distributed & dedicated	Centralized & shared using heat pipes		Distributed & dedicated	Distributed & shared using heat pipes	
Stirling Config.	2X 80W ASC	2X 200W ASC-H		4X 200W ASC-H		8X 200W ASC-H

Figure 2.—Nuclear Power Assessment Study (NPAS) Stirling Radioisotope Generator (SRG) and reactor system layouts.

Desired System Features

The Modular Stirling Radioisotope Generator (MSRSG) design is an attempt to incorporate some of the lessons learned from the ASRG development, and to address some of the concerns expressed by spacecraft mission planners during the NPAS. The following is a list of features to enhance the robustness and reliability in this new generator design:

1. GPHS heat should be shared between multiple Stirling convertors.
2. Design should be modular with respect to the number of GPHS modules, with the ability to scale the generator output from a single GPHS module up to eight GPHS modules. The upper limit was an arbitrary limit set to eight to match the number of GPHS modules used in a Multi-Mission Radioisotope Thermoelectric Generator (MMRTG).
3. Thermal insulation and Stirling convertor hot-end materials should be identical to those used in the ASRG (i.e., Mar-M 247 (nickel-based super alloy) and MicrothermHT) to leverage this very valuable work.
4. Nominal heater head operating temperature should be limited to 760 °C.
5. Stirling alternator temperature should not exceed 200 °C.
6. Coupling between the GPHS and the Stirling convertors should be radiative. This would eliminate coefficient of thermal expansion (CTE) challenges.
7. Convertor should have a fraction of Carnot efficiency of 50 percent. This is reduced from the Advanced Stirling Convertor's (ASC's) value of 56 percent of Carnot in order to allow larger internal clearances and thicker heat transfer walls.
8. Each Stirling convertor should have a dedicated controller with the two components (Stirling/controller) forming an independent DC power string. A greater number of strings is preferred to increase fault tolerance and mimic the many parallel strings that are used in the MMRTG (16 parallel strings).

Starting with these features, a number of observations were made about Stirling converters. The first is that Stirling converters tend to provide optimum specific power (W/kg) at an operating frequency of about 100 Hz. This results in a “rule of thumb” distance from the Stirling acceptor to the collector of about 8 cm with the Stirling convertor growing in cylindrical diameter as the design power level increases. The second observation is that Stirling converters scale to lower power without a significant change in specific power. This allows flexibility to reduce the size of individual converters to form a generator. Next, Stirling converters tend to have a high turndown ratio that can easily approach a value of 2:1. Turndown is the ratio of maximum to minimum power over which the fraction of Carnot efficiency changes are small. In the ASRG, estimates from beginning-of-life (BOL) to end-of-mission (EOM) power output of the generator would change by about 20 percent. This is far less than the 50-percent reduction in power that was possible in the ASC and this excess capability was not used. A final observation is that the surface area of a GPHS is sufficient to provide less than 100 °C temperature drop between the face of the GPHS and the heat collector when radiatively coupled to a Stirling convertor operating at 760 °C.

Design Concept

Using these observations, a wide range of generator designs were explored ending in a design that incorporated many of the features stated above. The concept uses four converters surrounding a single GPHS as the basic building block for a highly redundant, modular generator. Figure 3 shows one layer of the MSRSG not including the controller. The GPHS is radiatively coupled to the Stirling Heat Source Assembly (HAS), which transfers the heat to the Stirling acceptor. Radiative coupling reduces CTE issues by avoiding multiple structural connections with different materials between the convertor and generator. Additionally, each Stirling is connected to its own dedicated controller, which provides both control and rectification of the Stirling AC output. Three different methods of vibration cancellation are considered in this design: self-balanced converters, converters with dynamic balancers, and opposite pair balancing. Heat is rejected via the housing similar to the ASRG. However, the housing attaches directly to the Stirling rejector. The advantage of this design is that it removes the ASRG’s CSAF, allowing heat rejection to occur near the Stirling cycle cold-end temperature.

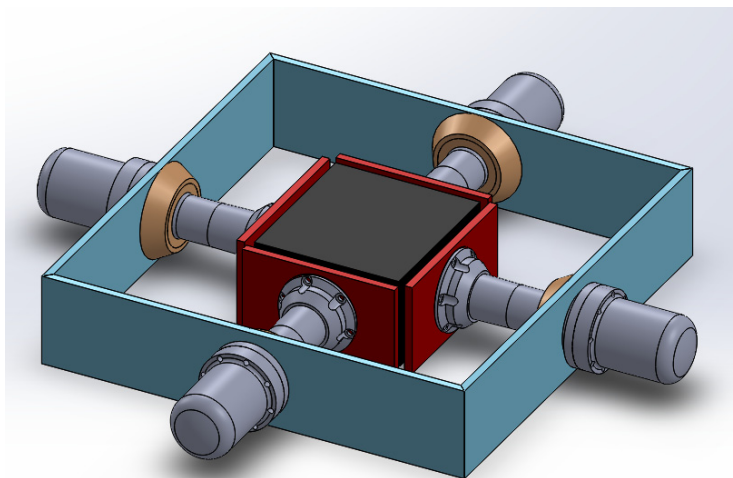

Figure 3.—Modular Stirling Radioisotope Generator layer.

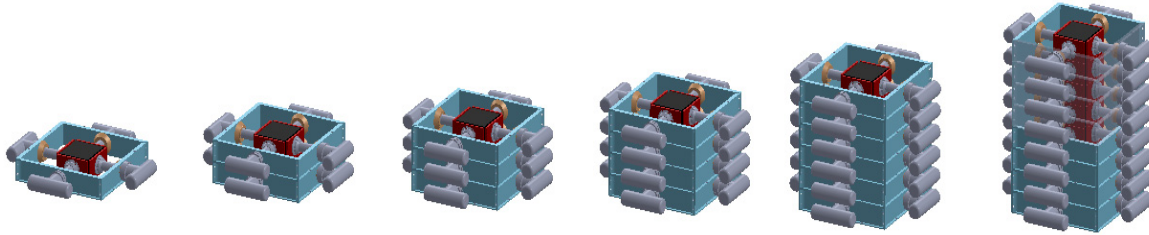

Figure 4.—One, two, three, four, six, and eight layer Modular Stirling Radioisotope Generator.

Figure 4 shows the single GPHS/4 Stirling building block stacked with a varying number of layers to create multiple generator configurations. In the event of a Stirling failure, the GPHS heat that was being used by that convertor is redistributed to the surrounding three HSAs and also up and down the GPHS stack to other layers. The remaining convertors can utilize the radiator surface near the failed convertor effectively because of the high-conductivity housing material and the close proximity of the working convertors. After a convertor failure, the piston amplitude of the remaining convertors can be changed to both increase power output and control operating temperature. Additionally, this design may allow for convertors to be maintained in hot standby and started only when needed, which could further increase the reliability of the system.

Generator Reliability

This generator design was selected because it offered the potential to have a large number of parallel strings, each capable of converting the GPHS heat into DC power for the spacecraft bus. The reliability of a system with spares is detailed in Reference 4. Three methods of balancing the periodic forces generated by the Stirling convertor were explored. The first method was to couple two 180° out-of-phase convertors (similar to the ASRG). If this is done we have effectively reduced the number of parallel strings. As an example, in a 4-GPHS generator, we drop from having 16 strings to 8. If a convertor fails in this design, its opposite convertor must be shut down. If we have each Stirling convertor self-balanced, then we can view all 16 Stirling convertors/controllers as independent strings. Two self-balancing Stirling convertor configurations were considered for this design. The first was to use a T-configuration alternator, which would eliminate most of the shaking forces generated by the power piston/alternator assembly. The disadvantage is the additional reliability reduction to having two alternators and the residual vibrations generated from the displacer. The second option is to place a dynamic balancer on each convertor. The advantage of this design is that the majority of the shaking force from each Stirling is eliminated (including displacer). The disadvantage is that the system requires a balancer controller, motor, and moving mass, which would decrease string reliability and consume some power. Table 1 shows the Stirling convertor/housing/balancer reliability chains for all of these options. These reliability numbers are based on the ASRG Failure Mode, Effects, and Criticality Analysis (FMECA) report and other work performed during the NPAS study.

The highest projected efficiency from the above strings is the unbalanced Stirling attached to the housing and a single card controller. Because this does not include a balancing element, it must be electrically coupled with its opposite convertor. The second-best efficiency string is the T-convertor with no additional balancing for the displacer motion. This dual alternator reduces the reliability of the string by 0.2 percent (assumed identical to the ASC FMECA reliability projection). Additionally it requires that the spacecraft be capable of accepting a periodic 90 N of shaking force (derived from estimates of the 16 displacers in a 4-GPHS MSRG under worst-case conditions). The T-convertor with the balancer has the lowest string reliability at 90.9 percent including both the double alternator and the balancer reliability. Little advantage was seen using the T-configuration with a balancer, but that was kept for completeness. The single alternator Stirling with a balancer has a 91.1 percent projected string reliability and allows for single string operation.

TABLE 1.—STIRLING CONVERTOR BALANCING OPTIONS AND PROJECTED RELIABILITIES

Case	Description	ACU, ^a percent	ASC, ^b percent	GHA, ^c percent	Balancer, percent	Extra alternator, percent	System POF, ^d percent	Reliability, percent
Advanced Stirling Radioisotope Generator (ASRG)	Controller has backup card	1.29	1.76	0.07	0.00	0.00	3.1	96.9
Single alternator convertor/housing/controller + balancer	Single string operation	5.91	0.91	0.07	2.00	0.00	8.9	91.1
T-convertor/housing/controller	Single string operation but displacer vibration	5.91	0.91	0.07	0.00	0.20	7.1	92.9
T-convertor/housing/controller + balancer	Single string operation	5.91	0.91	0.07	2.00	0.20	9.1	90.9
Single alternator convertor/housing/controller	Requires cross-link to opposite convertor	5.91	0.91	0.07	0.00	0.00	6.9	93.1

^aACU is Advanced Stirling Convertor Controller Unit.

^bASC is Advanced Stirling Convertor.

^cGHA is generator housing assembly.

^dPOF is probability of failure.

By placing the strings into a generator, we can compare the overall generator reliability for various combinations of parallel strings and allowed failure modes. As was discussed earlier, Stirling convertors have a turndown ratio of about 2:1. Combining this turndown ratio with a generator reliability requirement we can determine the allowable number of operating convertors to satisfy both constraints. Figure 5 shows that using the ASRG’s 96.5-percent projected reliability and a 4-GPHS MSRГ that the range of operating convertors that meet both criteria are either 10, 11, or 12 convertors (4 to 6 failures) are operating out of the initial 16 parallel strings. The assumption inherent in all of these calculations is that the remaining working convertors will utilize the GPHS heat necessary to make up the power loss of the failed convertors and that they will all produce identical power outputs.

For the 4-GPHS MSRГ, the system would have 8 parallel strings with opposed convertor pairs or 16 parallel strings with individually balanced convertors. Assuming we can tolerate 25 percent failures (i.e., 12/16 or 6/8) the overall reliability of the generator can be determined for each string architecture. Table 2 shows the results of projected reliability for the string reliabilities derived in Table 1. The highest BOL reliability generator is the T-configuration without a balancer coming in at 99.6 percent. However, this requires that the spacecraft can tolerate the occasional 90 N of shaking force generated by the 16 unbalanced displacers. An alternative that offers similar reliability and alleviates the vibration issue uses the conventional ASC-type Stirling with a dynamic balancer producing a generator reliability of 99.0 percent. Because this reliability is better than the other configurations, which are either cross-linked or need multiple alternators, it was selected as the baseline design. Note also that at EOL it is possible to use fewer convertors while staying within the 2:1 turndown ratio of the Stirling convertors. This results from the isotope fuel decay, which reduces the total thermal power and provides more headroom for the working convertors. Going forward we will look in greater detail at a 4-GPHS, 16 Stirling/balancer generator with a minimum of 12 operating convertors to illustrate how the system performs.

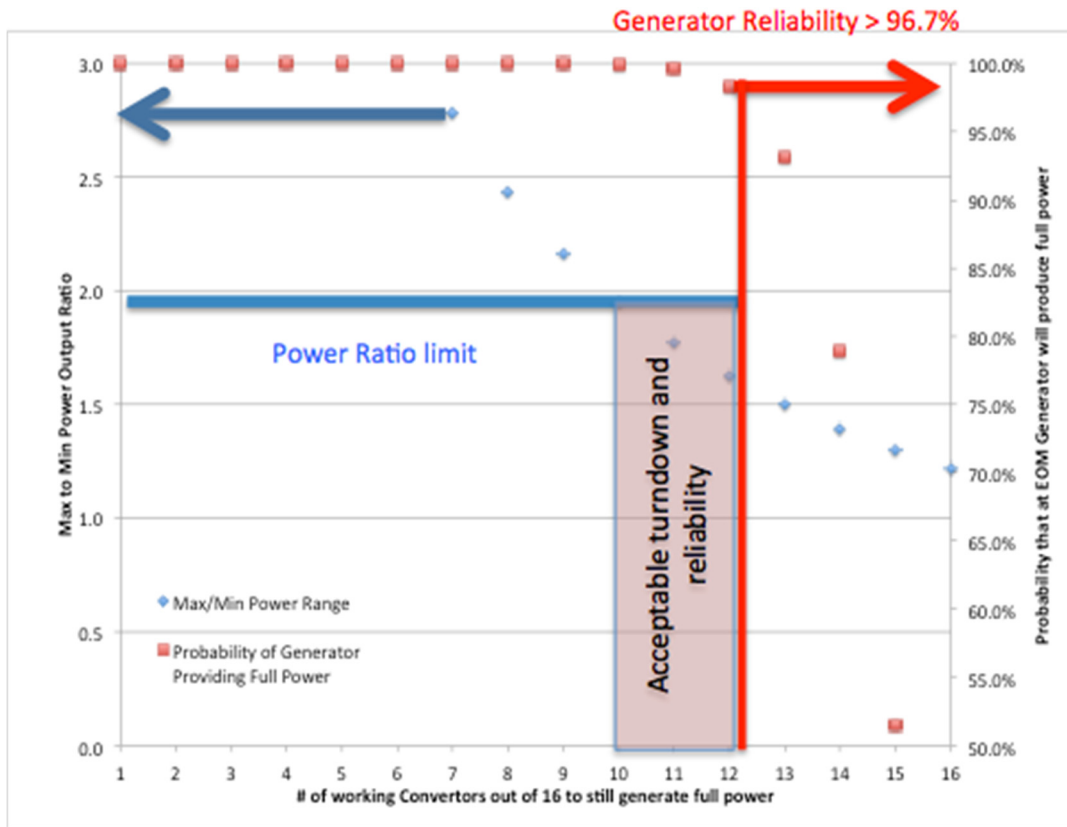

Figure 5.—Reliability and turndown ratio.

TABLE 2.—GENERATOR RELIABILITY AS A FUNCTION OF STRING COMPOSITION

Case	String reliability, percent	No. of strings	No. required	Generator reliability BOL, ^a percent	Generator reliability EOL, ^b percent
Single alternator convertor/housing/controller + balancer	91.1	16	12	99.0	99.98
T-convertor/housing/controller	92.9	16	12	99.6	99.99
T-convertor/housing/controller + balancer	90.9	16	12	98.9	99.97
T-convertor/housing/controller cross-linked	92.9	8	6	98.5	99.86
Single alternator convertor/housing/controller cross-linked	93.1	8	6	98.6	99.87

^aBOL is beginning of life.

^bEOL is end of life.

System Analysis

Thermal and electrical power analysis was performed using MATLAB/Simscape (The Mathworks, Inc.). This modeling software was used to create a thermal network that represented all of the major components of the MSRГ. Thermal conductivity, physical dimensions, emissivity, and mass and heat capacity are all used to create a model that provides both steady state and transient behavior of the generator. The model provides output of both temperature and heat flow through the components that make up the system. As an example, Figure 6 shows the heat flow from one side of a GPHS, through the Stirling convertor and into the housing. The methodology used in the model was validated by developing an ASRG version that matched the ASRG output conditions.

The focus of the results section will be on a 4-GPHS MSRГ. Figure 7 shows a drawing of this generator using either a T-configuration alternator or a conventional Stirling convertor along with rough dimensions. No thermodynamic differences are projected between the two configurations although the T-configuration was estimated to produce a slightly higher convertor mass. This generator includes 5-in. fins and has been analyzed using a variety of housing materials. As a starting point, a beryllium housing was considered that was similar in thickness to the ASRG housing. Variations in both housing thickness and material were analyzed in order to assess their importance on system mass and design and off-design performance of the MSRГ.

Table 3 shows a range of materials and thicknesses for the MSRГ housing. Housing materials include beryllium, aluminum, and k-Core, a high-conductivity material made by combining aluminum with annealed pyrolytic graphite (APG) inserts and developed by Thermacore (Ref. 5). The best specific power (3.1 W/kg) and total power output (243 W BOL) was realized using the k-Core housing material assuming a 4 K thermal sink and with all four GPHS modules supplying 244 W of heat output at BOM. The k-Core thickness was kept the same as the average thickness of the ASRG beryllium housing. The second-best specific power case came with the beryllium housing at ASRG nominal thickness producing 225 W of DC power with a specific power of 3 W/kg. More important to the system is that the cold-end temperature decreased from 183 °C using beryllium to 133 °C using k-Core. This 50 °C decrease in temperature is directly attributed to the increased thermal effectiveness of the radiator (housing). Doubling the beryllium housing thickness only dropped the cold-end temperature by 20 °C while increasing the generator mass by about 10 kgs. The design of the MSRГ with this geometry appears to greatly benefit from a high-conductivity radiator material.

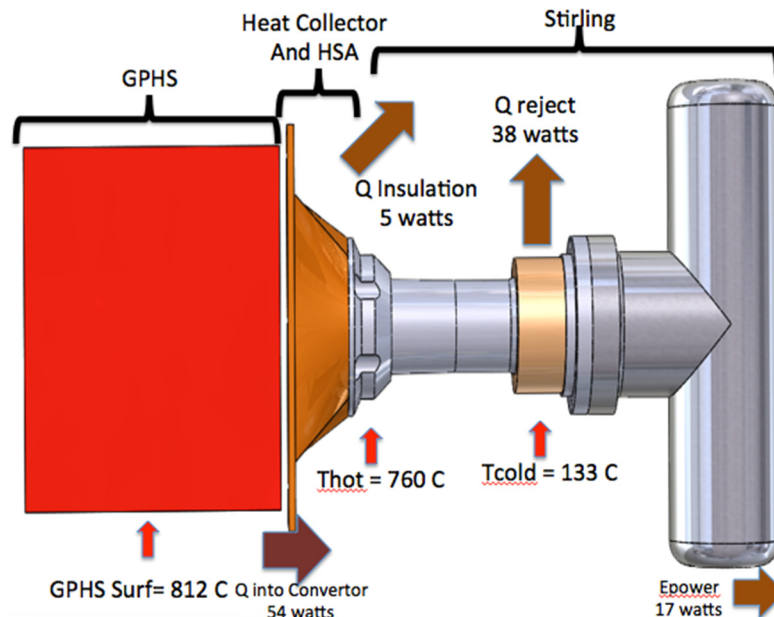

Figure 6.—Simscape temperature and heat flow output.

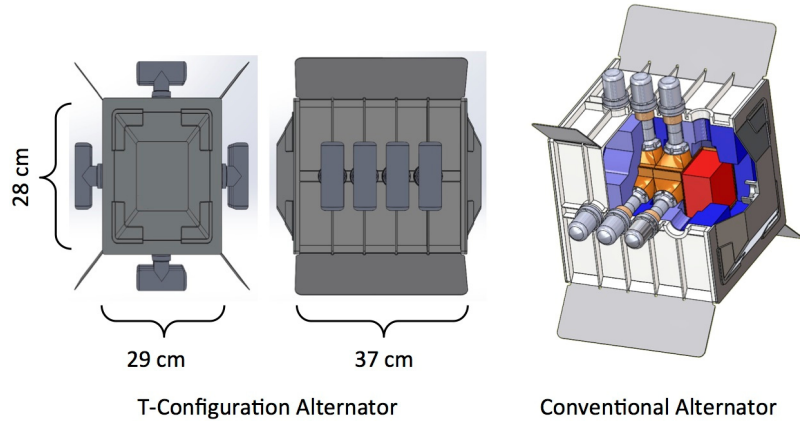

Figure 7.—A 4-GPHS (General Purpose Heat Source) Modular Stirling Radioisotope Generator layout.

TABLE 3.—HOUSING MATERIAL COMPARISON

Additional distance per convertor to housing	Housing material	Housing thickness, cm	DC ^a BOL ^b power output, W	DC EOL ^c power output, W	No. operating/total	Thot	Tcold	Mass, kg, spec power (W/kg)	No. GPHS ^d modules, 244 W
10%	Be	0.4436	225	185	16/16	760 °C	183 °C	75 (3.0)	4
10%	Be	0.4436×2	232	190	16/16	760 °C	164 °C	83 (2.8)	4
10%	Al	0.4436×1.12×2	230	189	16/16	760 °C	169 °C	98.45 (2.3)	4
10%	k-Core	0.4436	243	208	16/16	760 °C	133 °C	78 (3.1)	4
ASRG ^e	Be	0.4436	140	115	-----	760 °C	38 °C	32 (4.4)	2
MMRTG ^f	Al		122	53	-----	-----	-----	44 (2.7)	8

^aDC is direct current.

^bBOL is beginning of life.

^cEOL is end of life.

^dGPHS is General Purpose Heat Source.

^eASRG is Advanced Stirling Radioisotope Generator.

^fMMRTG is Multi-Mission Radioisotope Thermoelectric Generator.

The controller for the MSRSG is in concept very similar to the ACU used in the ASRG. The MSRSG controller would use open loop voltage control to control the stroke and frequency of the Stirling. Additionally, it would convert the AC power generated by the Stirling to DC power for the spacecraft bus. The controller includes a Mil-STD-1553 communication card, a dedicated electric power shunt interface, and a piston position sensor. Because the MSRSG has many parallel power strings, the individual strings do not require a 3-card controller with a standby card to accommodate failure. Therefore, the efficiency was increased from 87 percent for the ACU to 92 percent for the MSRSG controller. Mass estimates were based on the full mass of a single ACU card (1.8 kg). The MSRSG controller assembly mass was scaled based on the housing and backplane from the ACU. Further refinement is anticipated since the current ACU card can process 80+ W AC while the new card only needs to process about 25 W.

TABLE 4.—SYSTEM FAULT ANALYSIS

Description	Housing material	Housing thickness, cm	DC power output	No. operating/ total	Thot	Tcold	Failed Thot
Nominal operation	k-Core	0.4436	243	16/16	760 °C	133 °C	NA
One failed no adjustment	k-Core	0.4436	245	15/16	797 °C	130 °C	857 °C
Final operation one out	k-Core	0.4436	241	15/16	760 °C	134 °C	820 °C
Four failed single row—final	k-Core	0.4436	234	12/16	760 °C	136 °C	914 °C

Assuming the k-Core housing as a baseline, four separate convertor fault cases were considered as presented in Table 4. The first case was a BOL nominal operation with a 760 °C Stirling acceptor temperature and the k-Core housing thickness set equal to the average thickness of the ASRG (0.4436 cm). With all 16 convertors operational, the system produces 243 W. The second case shows a single Stirling convertor failure (15/16) without any stroke adjustments for the remaining working convertors. This case is important because it reveals the equilibrium temperature of the remaining working convertors (797 °C) and the maximum temperature seen by the insulation near the failed convertor (857 °C). Failing a single convertor without changing the piston strokes causes a slight rise in DC power to 245 W. In the next case, piston stroke adjustments are made to the remaining 15 convertors to restore their acceptor temperatures to the nominal operating condition of 760 °C. This action would be initiated through a command to the controllers or implemented through an automated, onboard control algorithm. The stroke adjustment results in a generator power output of 241 W. In the last case, four Stirling convertors fail on the same, outside row (worst case). The stroke is adjusted on the remaining 12 convertors to restore the 760 °C acceptor temperature, the generator power output decreases to 234 W, and the insulation sees a maximum temperature of 914 °C.

Of great importance for this design is that when a convertor fails, the surrounding convertors and insulation do not exceed the insulation deformation limit (1000 °C) or the creep temperature limit of the working convertors. Figure 8 shows the temperature rise of the failed convertor after a failure at t+70 hr. The transient temperature response of the failed convertor reaches steady state after about t+70 hr with a peak temperature of 857 °C (1130 K). This temperature is very near the design temperature (860 °C) of the MarM-247 heater head in the ASRG.

Table 5 shows the DC power output as a function of convertor location in the 4-layer MSRSG after an entire row of convertors has failed. In order to maintain 760 °C acceptor temperatures, row 2 power output must increase from 15 to 25 W while row 3 increases about 2 W. The assumption of evenly distributed power does not appear to be possible when the acceptor temperature of the remaining convertors are adjusted to near 760 °C. Table 6 shows their final temperatures after adjusting piston stroke. This analysis suggests that the failure of the convertors will not damage the insulation or the surrounding convertors.

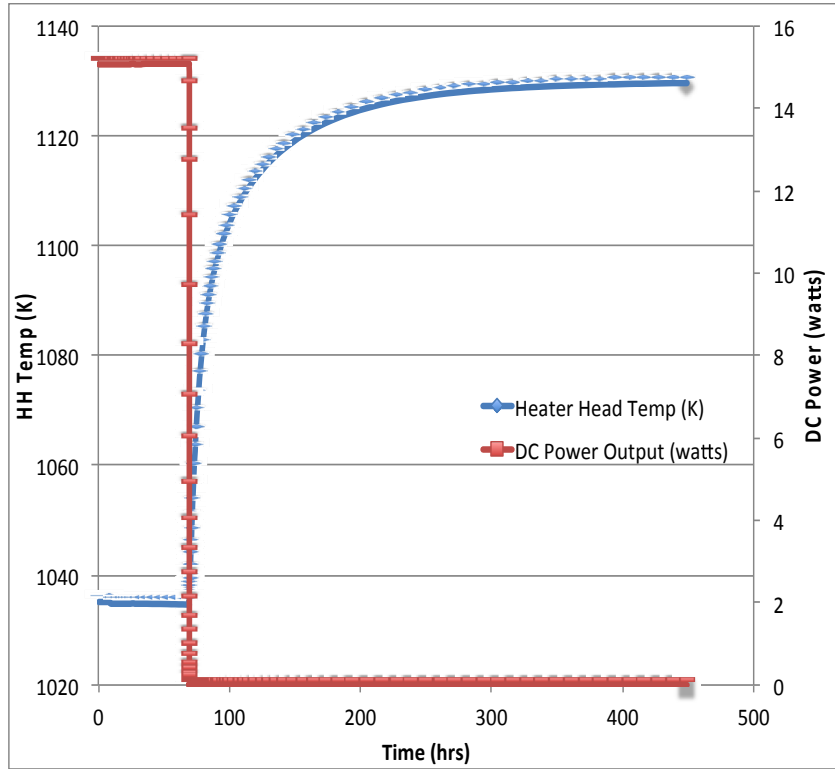

Figure 8.—Failed convertor transient heater head temperature.

TABLE 5.—DIRECT CURRENT (DC) POWER (WATTS) OUTPUT WITH FOUR CONVERTORS FAILED

	A	B	C	D
Row 1	0	0	0	0
Row 2	24.3	24.6	24.3	24.6
Row 3	17.4	17.6	17.4	17.6
Row 4	16.5	16.6	16.5	16.6

TABLE 6.—HEATER HEAD TEMPERATURE (°C) AFTER STROKE ADJUSTMENT

	A	B	C	D
Row 1	914.1	914.7	914.1	914.7
Row 2	763.8	770.0	763.8	770.0
Row 3	763.2	767.9	763.2	767.9
Row 4	753.0	757.6	753.0	757.6

TABLE 7.—ONE TO EIGHT GENERAL PURPOSE HEAT SOURCE (GPHS) MODULAR STIRLING RADIOISOTOPE GENERATOR SUMMARY

No. of GPHS modules	Direct current (DC) power output beginning of life (BOL), W	Full power output 25 percent of convertors failed BOL (W)	DC power output end of life, W (17 yr)	Mass, kg	Specific power, W/kg
1	55	53 (3/4)	45	21	2.6
2	118	114 (6/8)	97	39	3.1
3	180	171 (9/12)	148	53	3.4
4	243	235 (12/16)	200	69	3.5
5	306	296 (15/20)	251	86	3.6
6	369	357 (18/24)	303	103	3.6
7	432	410 (21/28)	355	118	3.7
8	494	478 (24/32)	404	134	3.7

Analysis of the entire range from 1 to 8 GPHS MSRSG was conducted and is shown in Table 7. Full output power ranges from 53 to 478 W at BOL. This is assuming that each GPHS produces 244 W of thermal output at BOL with heat rejected to a 4 K sink. Power output without any convertor failures is shown in column 1. DC power output after 17 years of operation ranges from 45 to 404 W. Because of relatively fixed end cap losses, specific power increases with increasing number of MSRSG layers and ranges from 2.6 W/kg with a single GPHS to 3.7 W/kg for an 8 GPHS MSRSG.

Conclusions

A new design architecture for a Stirling Radioisotope Generator (SRG) model provides a highly redundant and scalable power system. This design takes advantage of the physical geometry of Stirling convertors, their excellent power scaling, and their ability to vary operating conditions to achieve a wide range of power output and thermal conditions. This design attempts to address some of the concerns with the Advanced Stirling Radioisotope Generator (ASRG) while sacrificing mass for reliability/robustness. Additionally, the Modular Stirling Radioisotope Generator (MSRSG) maintains the high generator efficiency to reduce Pu-238 consumption. Generator level power output is scalable from 53 to 478 W direct current using one to eight General Purpose Heat Source (GPHS) modules. The generator can tolerate 25 percent of the convertors failing at beginning of life and still provide full power output. Additional convertor failures can be tolerated beyond the 25 percent as the fuel decays.

References

1. The Johns Hopkins University Applied Physics Laboratory: Nuclear Power Assessment Study. 2015. <http://fas.org/nuke/space/npas-2015.pdf> (Accessed Feb. 5, 2016).
2. Advanced Stirling Radioisotope Generator. NASA ASRGfacts, 2010. <https://tec.grc.nasa.gov/files/RPS-ASRG-Handout.pdf> (Accessed Feb. 15, 2010).
3. Dreier, Casey: NASA Just Cancelled its Advanced Spacecraft Power Program: The Advanced Stirling Radioisotope Generator Was To Use Less Plutonium for Cheaper Missions. Planetary Society Online Document, 2013. <http://www.planetary.org/blogs/casey-dreier/2013/20131115-nasa-just-cancelled-its-asrg-program.html> (Accessed Nov. 15, 2013).
4. Bolotin, G., et al.: The Use of Redundancy to Improve Reliability of Deep Space Missions Using Stirling Radioisotope Generator Power Sources. Joint Propulsion Conferences, 12th International Energy Conversion Engineering Conference, AIAA, Cleveland, OH, 2014.
5. kCore. Thermacore, 2013. http://www.thermacore.com/documents/k-Core_Product_%20Brochure.pdf (Accessed Feb. 5, 2016).

